

**ANIMAL VEHICLE CRASH
MITIGATION USING
ADVANCED TECHNOLOGY
PHASE I: REVIEW, DESIGN AND
IMPLEMENTATION**

Final Report

SPR-3(076)

**ANIMAL VEHICLE CRASH MITIGATION USING ADVANCED
TECHNOLOGY
PHASE I: REVIEW, DESIGN AND IMPLEMENTATION**

SPR-3(076)

by

Marcel P. Huijser, Patrick T. McGowen, Whisper Camel, Amanda Hardy, Patrick Wright, and
Anthony P. Clevenger

Western Transportation Institute - Montana State University
P.O. Box 174250, Bozeman, MT 59717-4250

and

Lloyd Salsman and Terry Wilson
Sensor Technologies and Systems, Inc.
8900 East Chaparral Road, Scottsdale, Arizona 85250

for

Oregon Department of Transportation
Research Unit
200 Hawthorne Ave. SE, Suite B-240
Salem OR 97301-5192

and

Alaska Department of Transportation and Public Facilities, and the Departments of
Transportation of California, Indiana, Iowa, Kansas, Maryland, Montana, Nevada, New
Hampshire, New York, North Dakota, Pennsylvania, Wisconsin, and Wyoming

and

Federal Highway Administration
400 Seventh Street SW
Washington, DC 20590

August 2006

1. Report No. FHWA-OR-TPF-07-01		2. Government Accession No.		3. Recipient's Catalog No.	
4. Title and Subtitle Animal Vehicle Crash Mitigation Using Advanced Technology Phase I: Review, Design and Implementation				5. Report Date August 2006	
				6. Performing Organization Code	
7. Author(s) Marcel P. Huijser, Patrick T. McGowen, Whisper Camel, Amanda Hardy, Patrick Wright, and Anthony P. Clevenger Western Transportation Institute - Montana State University P.O. Box 174250, Bozeman, MT 59717-4250 Lloyd Salsman and Terry Wilson Sensor Technologies and Systems, Inc. 8900 East Chaparral Road, Scottsdale, Arizona 85250				8. Performing Organization Report No.	
9. Performing Organization Name and Address Western Transportation Institute - Montana State University P.O. Box 174250 Bozeman, MT 59717-4250				10. Work Unit No. (TRAIS)	
				11. Contract or Grant No. SPR 3(076)	
12. Sponsoring Agency Name and Address Lead state: Oregon Department of Transportation Federal Highway Administration Research Unit and 400 Seventh Street SW 200 Hawthorne Ave. SE, Suite B-240 Washington, D.C. 20590 Salem, Oregon 97301-5192 Also: Alaska Department of Transportation and Public Facilities, and the Departments of Transportation of California, Indiana, Iowa, Kansas, Maryland, Montana, Nevada, New Hampshire, New York, North Dakota, Pennsylvania, Wisconsin, and Wyoming Pooled fund study SPR 3(076): http://www.pooledfund.org/projectdetails.asp?id=222&status=6				13. Type of Report and Period Covered Final report - Phase I October 1999 - December 2005	
				14. Sponsoring Agency Code	
15. Supplementary Notes					
16. Abstract Animal-vehicle collisions affect human safety, property and wildlife. The number of these types of collisions has increased substantially over the last decades. This report describes the results of a project that explored the prospects for a relatively new mitigation measure to reduce animal-vehicle collisions: animal detection systems. Animal detection systems use high tech equipment to detect large animals when they approach the road. Once a large animal is detected, warning signs are activated urging drivers to reduce the speed of their vehicles, be more alert, or both. Lower vehicle speed and increased alertness may then lead to fewer and less severe collisions with such animals as deer (<i>Odocoileus sp.</i>), elk (<i>Cervus elaphus</i>) or moose (<i>Alces alces</i>). This report documents Phase I of the project (October 1999 - December 2005). The report identifies existing animal detection system technologies and their vendors; describes the selection of two experimental detection systems and their installation at two field sites; documents the experiences with planning and design, installation, operation and maintenance; documents test results on the reliability of the two systems; documents system acceptance; and provides advice for the future development and application of animal detection systems.					
17. Key Words Accident reduction, Animal detection systems, Animal-vehicle collision, Habitat connectivity, Dynamic warning signs, Intelligent Transportation Systems (ITS), Mitigation, Road-kill, Safety, Ungulates, Wildlife			18. Distribution Statement Copies available from NTIS, and online at http://www.oregon.gov//ODOT/TD/TP_RES/		
19. Security Classification (of this report) Unclassified		20. Security Classification (of this page) Unclassified		21. No. of Pages 214 + appendices	
				22. Price	

SI* (MODERN METRIC) CONVERSION FACTORS

APPROXIMATE CONVERSIONS TO SI UNITS

Symbol	When You Know	Multiply By	To Find	Symbol
<u>LENGTH</u>				
in	inches	25.4	millimeters	mm
ft	feet	0.305	Meters	m
yd	yards	0.914	Meters	m
mi	miles	1.61	kilometers	km
<u>AREA</u>				
in ²	square inches	645.2	millimeters squared	mm ²
ft ²	square feet	0.093	meters squared	m ²
yd ²	square yards	0.836	meters squared	m ²
ac	acres	0.405	Hectares	ha
mi ²	square miles	2.59	kilometers squared	km ²
<u>VOLUME</u>				
fl oz	fluid ounces	29.57	Milliliters	mL
gal	gallons	3.785	Liters	L
ft ³	cubic feet	0.028	meters cubed	m ³
yd ³	cubic yards	0.765	meters cubed	m ³
NOTE: Volumes greater than 1000 L shall be shown in m ³ .				
<u>MASS</u>				
oz	ounces	28.35	Grams	g
lb	pounds	0.454	Kilograms	kg
T	short tons (2000 lb)	0.907	megagrams	Mg
<u>TEMPERATURE (exact)</u>				
°F	Fahrenheit temperature	5(F-32)/9	Celsius temperature	°C

APPROXIMATE CONVERSIONS FROM SI UNITS

Symbol	When You Know	Multiply By	To Find	Symbol
<u>LENGTH</u>				
mm	millimeters	0.039	inches	in
m	meters	3.28	feet	ft
m	meters	1.09	yards	yd
km	kilometers	0.621	miles	mi
<u>AREA</u>				
mm ²	millimeters squared	0.0016	square inches	in ²
m ²	meters squared	10.764	square feet	ft ²
ha	hectares	2.47	acres	ac
km ²	kilometers squared	0.386	square miles	mi ²
<u>VOLUME</u>				
mL	milliliters	0.034	fluid ounces	fl oz
L	liters	0.264	gallons	gal
m ³	meters cubed	35.315	cubic feet	ft ³
m ³	meters cubed	1.308	cubic yards	yd ³
<u>MASS</u>				
g	grams	0.035	ounces	oz
kg	kilograms	2.205	pounds	lb
Mg	megagrams	1.102	short tons (2000 lb)	T
<u>TEMPERATURE (exact)</u>				
°C	Celsius temperature	1.8C + 32	Fahrenheit	°F

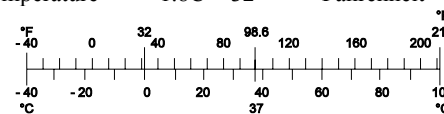

* SI is the symbol for the International System of Measurement

ACKNOWLEDGEMENTS

The authors would like to thank the agencies that funded this study: the Federal Highway Administration (FHWA) and 15 departments of transportation: Alaska Department of Transportation and Public Facilities, and the Departments of Transportation of California, Indiana, Iowa, Kansas, Maryland, Montana, Nevada, New Hampshire, New York, North Dakota, Oregon, Pennsylvania, Wisconsin, and Wyoming. Other funds were received from the Western Transportation Institute at Montana State University (University Transportation Center funds).



Representatives of the 15 DOTs and FHWA that funded the project, and representatives from Yellowstone National Park, the vendors, and WTI-MSU during a field visit at the MT site
(Photo: Pat McGowen, WTI-MSU).

Special thanks go to the following:

- Oregon Department of Transportation for leading this pooled fund study and assisting with the preparation of this report;
- Montana Department of Transportation and Yellowstone National Park for their help and hosting the animal detection system along US Hwy 191 in Yellowstone National Park; and
- Pennsylvania Department of Transportation for their help and hosting the animal detection system along Hwy 22/322 northwest of Harrisburg.



Representatives of PennDOT and Maryland Department of Transportation during a field visit at the PA site
(Photo: Marcel Huijser/ WTI-MSU).

In addition, we would like to thank the current and former members of the Technical Advisory Committee (TAC) (see Appendix A), FHWA representatives and other advisors for their help and guidance for this project: Clint Adler, Alisa Babler, Fred Bank, Pat Basting, Anthony Boesen, William Branch, Dave Church, Mike Clarke, Allan Covlin, Justin Farrell, Jon Fleming, Gary Frederick, Steve Gent, Bill Gribble, Sedat Gulen, Kevin Haas, Pete Hansra, Amanda Hardy, Kim Hoovestol, Lynn Irby, Bernie Jones, John Kinar, Keith Knapp, Felix Martinez, Rex McCommon, Pat McGowen, Andrew Morrow, AJ Nedzesky, Greg Placy, Kevin Powell, Bob Raths, Jaime Reyes, June Ross, Barbara Schell-Magaro, Jay Van Sickle, Sue Sillick, Richard Stark, Jill Sullivan, Carol Tan, Mark Traxler, Deb Wambach, Davey Warren, Kyle Williams, and Patrick Wright.

Thanks also to Steve Albert, Rick Bennett, Stephanie Brandenberger, Jeralyn Brodowy, Mike Bousliman, Kevin Bruski, Whisper Camel, Tony Clevenger, Vincent Cramer, Troy Davis, Maurice Dedycker, Jerry Dupler, Jaime Eidswick, Bonnie Gafney, Ross Gammon, Lori Gruber, Julie Hannaford, Amanda Hardy, Christie Hendrix, Neil Hetherington, Manju Kumar, Robb Larson, Shel Leader, Craig McClure, Leslie McCoy, Keith Mullins, Stanley Niemczak, Jason Norman, Roy Parmly, Mark Petersen, John Powell, Dennis Prestash, James Roman, Russell Rooney, Bob Seibert, James Shype, Rhonda Stankavich and Pat Wright for their help with the planning (including permitting and engineering plans), installation (including traffic control), operation, maintenance, or other activities related to the animal detection systems along US Hwy 191 in Yellowstone National Park, MT, and along hwy 22/322 northwest of Harrisburg, PA.

The animal detection systems were designed and developed by Sensor Technologies and Systems (MT site) and Oh DEER, Inc. (PA site). We would like to thank them for their efforts, specifically Walker Butler, Dennis and Nick Henningsen, Steve Miller, Randy Moore, Nik Nikula, Steve Pisciotta, Lloyd Salsman, Roger Werre and Terry Wilson. Michiana Contracting Inc., Eagle Rock Timber and Dependable Paint and Drywall installed and painted the system at the MT site. Thanks to Scott Ammerman, Dave Delp, Rick Gokey, Scott Harris and Ping McKay

for these efforts. We would also like to thank Duncan, Eva and Robin Patten, and Greg and Sara Knetge for their help, support, hospitality and feedback on the system at the MT site.

Finally we thank Steve Albert, Alisa Babler, William Branch, Wayne Brewster, Kevin Bruski, Tony Clevenger, Allan Covlin, Carol Diffendaffer, Jon Fleming, Bill Gribble, Edgar van der Grift, Sedat Gulen, Joel Hagen, Pete Hansra, Amanda Hardy, Kate Heidkamp, Christie Hendrix, Nick Henningsen, Keith Knapp, Carla Little, Alan Kirk, Felix Martinez, Leslie McCoy, Pat McGowen, AJ Nedzesky, Greg Placy, Jaime Reyes, June Ross, Lloyd Salsman, Rhonda Stankavich, Jay Van Sickle, John Taylor, Bethanie Walder, Deb Wambach, Terry Wilson and Patrick Wright for reviewing a draft of this manuscript or parts thereof.

DISCLAIMER

This document is disseminated under the sponsorship of the Oregon Department of Transportation and the United States Department of Transportation in the interest of information exchange. The State of Oregon and the United States Government assume no liability of its contents or use thereof.

The contents of this report reflect the view of the authors who are solely responsible for the facts and accuracy of the material presented. The contents do not necessarily reflect the official views of the Oregon Department of Transportation or the United States Department of Transportation.

The State of Oregon and the United States Government do not endorse products of manufacturers. Trademarks or manufacturers' names appear herein only because they are considered essential to the object of this document.

This report does not constitute a standard, specification, or regulation.

**ANIMAL VEHICLE CRASH MITIGATION USING ADVANCED
TECHNOLOGY
PHASE I: REVIEW, DESIGN AND IMPLEMENTATION**

TABLE OF CONTENTS

EXECUTIVE SUMMARY	1
1.0 INTRODUCTION	15
1.1 BACKGROUND	15
1.2 STUDY OBJECTIVES.....	16
1.3 PROJECT FUNDING.....	17
1.4 STRUCTURE OF THE REPORT	18
2.0 ANIMAL DETECTION SYSTEMS: PRINCIPLES	19
2.1 SYSTEMS CONCEPTS STUDIED	19
2.2 CONCEPT OF OPERATION.....	19
2.3 SYSTEM RELIABILITY AND EFFECTIVENESS	20
2.4 SYSTEM TECHNOLOGIES	21
3.0 RESEARCH QUESTIONS, METHODS AND CURRENT UNDERSTANDING OF SYSTEM RELIABILITY AND EFFECTIVENESS	23
3.1 SYSTEM RELIABILITY	23
3.1.1 False negatives.....	23
3.1.2 False positives	24
3.1.3 Downtime	24
3.1.4 Normalize false positives and false negatives	25
3.2 SYSTEM EFFECTIVENESS.....	26
3.2.1 Driver alertness.....	26
3.2.2 Vehicle speed.....	27
3.2.3 Animal-vehicle collisions.....	30
4.0 OVERVIEW OF ANIMAL DETECTION SYSTEMS THROUGHOUT NORTH AMERICA AND EUROPE	33
4.1 INTRODUCTION	33
4.2 METHODS	33
4.3 SYSTEM NUMBERS AND GENERAL LOCATION.....	34
4.4 EXISTING OR DISMANTLED SYSTEMS.....	35
4.4.1 Seven locations in Switzerland.....	35
4.4.2 Box, Finland	38
4.4.3 Mikkeli, Finland	39
4.4.4 Five sites in Switzerland; two sites in Germany	39
4.4.5 Two sites in the Netherlands	40
4.4.6 Rosvik, Sweden	44
4.4.7 Colville, Washington, USA.....	46

4.4.8	Nugget Canyon, Wyoming, USA.....	47
4.4.9	Sequim, Washington, USA.....	52
4.4.10	Marshall, Minnesota, USA.....	54
4.4.11	Kootenay National Park, British Columbia, Canada.....	56
4.4.12	Indiana Toll Road, Indiana, USA.....	57
4.4.13	Wenatchee, Washington, USA.....	60
4.4.14	Yellowstone National Park, Montana, USA.....	61
4.4.15	Los Alamos, New Mexico, USA.....	64
4.4.16	Thompsontown, Pennsylvania, USA.....	65
4.4.17	Herbertville, Quebec, Canada.....	66
4.4.18	Pinedale, Wyoming, USA.....	69
4.4.19	Norway.....	70
4.5	PLANNED SYSTEMS.....	70
4.5.1	McDonald Creek Area, California, USA.....	70
4.5.2	Preacher Canyon, Arizona, USA.....	71
4.5.3	Durango, Colorado, USA.....	71
4.5.4	Tijeras Canyon, New Mexico, USA.....	71
4.5.5	Wells, Nevada, USA.....	72
4.5.6	Flagstaff, Arizona, USA.....	72
4.5.7	Maine, USA.....	73
4.5.8	Weerterbosch, The Netherlands.....	73
4.5.9	15 Sites, Germany.....	73
4.5.10	≥4 Sites, Switzerland.....	73
4.6	ADDITIONAL ISSUES.....	73
4.7	DISCUSSION AND CONCLUSION.....	76
5.0	ANIMAL DETECTION SYSTEMS AND SITES IN MONTANA AND PENNSYLVANIA.....	79
5.1	INTRODUCTION.....	79
5.2	FIELD SITES.....	79
5.2.1	US Hwy 191, Yellowstone National Park, MT.....	80
5.2.2	Hwy 22/322, near Thompsontown, PA.....	83
5.3	ANIMAL DETECTION SYSTEMS.....	86
5.3.1	STS Animal Detection System (MT site).....	86
5.3.2	Oh DEER, Inc. Animal Detection System (PA site).....	92
5.4	ROLES AND RESPONSIBILITIES.....	97
5.4.1	US Hwy 191, Yellowstone National Park, MT.....	97
5.4.2	Hwy 22/322, near Thompsontown, PA.....	101
6.0	POST INSTALLATION MODIFICATIONS TO THE ANIMAL DETECTION SYSTEM IN MONTANA.....	105
6.1	INTRODUCTION.....	105
6.2	SYSTEM DESCRIPTION.....	105
6.2.1	Beam break technology.....	105
6.2.2	System lay-out.....	106
6.2.3	Transmitter/receiver stations.....	106
6.2.4	Beam assignments at the MT site.....	108

6.2.5	Detection process.....	108
6.3	RADS ANALYSIS AND REMEDIATION.....	109
6.3.1	RADS deficiencies	109
6.3.2	RADS component evaluation.....	111
6.3.3	Cross section studies.....	114
6.3.4	Link attenuation model verification	115
6.3.5	Detector model verification.....	115
6.3.6	Telemetry of critical data.....	115
6.3.7	RADS evaluation.....	116
6.3.8	RADS testing.....	119
6.3.9	Siting problems.....	123
6.3.10	RADS modifications	125
6.4	SECOND GENERATION RADS CHANGES	126
6.4.1	“On event” service.....	126
6.4.2	Commercial antennas	127
6.4.3	Reduced transmitter duty cycle	127
6.4.4	Reduced power consumption	127
6.4.5	Reduced system footprint	127
6.4.6	Installation rules for RADS installation	127
6.4.7	Satellite data service for remote access.....	127
6.5	SECOND GENERATION RADS PERFORMANCE.....	128
6.5.1	Reduced power consumption	128
6.5.2	Radio link data protocol, error-free operation.....	128
6.5.3	Smaller system footprint.....	128
6.5.4	Increased dynamic range	128
6.6	CURRENT STATUS (DECEMBER 2005).....	128
7.0	RELIABILITY, EFFECTIVENESS AND ACCEPTANCE OF THE ANIMAL DETECTION SYSTEMS IN MONTANA AND PENNSYLVANIA	131
7.1	INTRODUCTION	131
7.2	SYSTEM RELIABILITY – MONTANA SITE.....	131
7.2.1	Status of system and warning signs.....	131
7.2.2	Methods	133
7.2.3	Results	141
7.2.4	Discussion.....	154
7.2.5	Conclusion.....	156
7.2.6	Recommendations	157
7.3	SYSTEM RELIABILITY – PENNSYLVANIA SITE.....	158
7.4	SYSTEM EFFECTIVENESS TESTS	158
7.4.1	US Hwy 191, Yellowstone National Park, MT	158
7.4.2	Hwy 22/322, near Thompsontown, PA	159
7.5	SYSTEM ACCEPTANCE.....	159
7.5.1	US Hwy 191, Yellowstone National Park, MT	159
7.5.2	Hwy 22/322, near Thompsontown, PA	161
8.0	LESSONS LEARNED FROM THE ANIMAL DETECTION SYSTEM PROJECTS IN MONTANA AND PENNSYLVANIA	163

8.1	INTRODUCTION	163
8.2	CHALLENGES ENCOUNTERED	163
8.2.1	US Hwy 191, Yellowstone National Park, MT	163
8.2.2	Hwy 22/322, near Thompsontown, PA	170
8.3	LESSONS LEARNED.....	170
8.3.1	Planning and design.....	171
8.3.2	Installation	177
8.3.3	Operation and maintenance	180
9.0	COST-BENEFIT ANALYSES FOR ANIMAL DETECTION SYSTEMS	185
9.1	INTRODUCTION	185
9.2	METHODS	185
9.3	RESULTS	186
9.3.1	Vehicle repair costs	186
9.3.2	Human injuries	187
9.3.3	Human fatalities.....	188
9.3.4	Monetary value of animals	188
9.3.5	Removal and disposal costs of deer carcasses.....	189
9.3.6	Animal detection system costs	189
9.3.7	Cost-benefit analyses.....	190
9.4	DISCUSSION AND CONCLUSION.....	191
10.0	POTENTIAL APPLICATIONS	193
10.1	INTRODUCTION	193
10.2	POTENTIAL APPLICATIONS	193
10.2.1	Animal detection systems versus wildlife crossing structures	195
10.2.2	Wildlife fencing versus no wildlife fencing	196
11.0	CONCLUSIONS, RECOMMENDATIONS AND FUTURE RESEARCH	199
11.1	CONCLUSIONS AND RECOMMENDATIONS	199
11.2	FUTURE RESEARCH	201
12.0	REFERENCES	205
APPENDICES	215	
APPENDIX A:	TECHNICAL ADVISORY COMMITTEE MEMBERS	217
APPENDIX B:	FINANCIAL REPORT	221
APPENDIX C:	PROJECT HISTORY	223
APPENDIX D:	REQUEST FOR INFORMATION	249
APPENDIX E:	ANIMAL DETECTIONS SYSTEM MANUFACTURER CONTACT INFORMATION.....	253
APPENDIX F:	PROJECT PARTNERS AND CONTRACTORS	259
APPENDIX G:	PROJECT RELEATED PRESENTATIONS, AND PUBLICATIONS.....	263
APPENDIX H:	RAW DATA RELIABILITY TEST PENNSYLVANIA SITE.....	269

LIST OF TABLES

Table 3.1: Speed reduction comparisons – local vs. non-local drivers	28
Table 3.2: Collisions with large animals before and after detection system installation in Switzerland	31
Table 4.1: Characteristics of animal detection systems	36
Table 4.2: Characteristics of area cover systems in Switzerland	37
Table 4.3: Summary of issues, problems, and experience with operations	74
Table 5.1: Number of animal-vehicle collisions	83
Table 7.1: Status of the animal detection system at the Montana site between Nov 2004 and Mar 2005	132
Table 7.2: Detection data categories	134
Table 7-3: Parameters and definition for reliability norms	140
Table 7.4: Recorded crossings through snow tracking vs. crossings detected by animal detection system	149
Table 7.5: Detection zones where elk crossings were recorded through snow tracking but not by the animal detection system	149
Table 7-6: Reliability evaluation of the animal detection system	150
Table 9.1: Summary of costs of animal-vehicle collisions for deer, elk and moose	190

LIST OF FIGURES

Figure 1.1: Financial contributions (Total = \$1,065,000).....	17
Figure 2.1: Concept of operations	20
Figure 2.2: Warning signals and driver response.....	21
Figure 3.1: Comparing system reliability at multiple sensitivity settings for multiple systems	26
Figure 3.2: Sample size to detect speed reduction	29
Figure 4.1: Location of animal detection systems in North America	34
Figure 4.2: Location of animal detection systems in Europe.....	35
Figure 4.3: Warning signs with 40 km/h (25 mi/h) speed limit at a location in Switzerland (Photo: Mary Gray/FHWA)	38
Figure 4.4: Warning signals and sign in 't Harde, The Netherlands (Photo: Marcel Huijser/WTI/MSU)	40
Figure 4.5: Activated warning signal and sign in 't Harde, The Netherlands (Photo: Marcel Huijser/WTI-MSU) ...	41
Figure 4.6: Cabinet with infrared sensor in 't Harde, The Netherlands (Photo: Marcel Huijser/WTI-MSU)	41
Figure 4.7: Solar panel and control cabinet in 't Harde, The Netherlands (Photo: Marcel Huijser/WTI-MSU).....	42
Figure 4.8: Control cabinet in 't Harde, The Netherlands (Photo: Marcel Huijser/WTI-MSU).....	42
Figure 4.9: Warning signal and sign in Ugchelen, The Netherlands (Photo: Marcel Huijser/WTI-MSU).....	43
Figure 4.10: Cabinet with infrared sensor in Ugchelen, The Netherlands	44
Figure 4.11: Warning signs in Rosvik, Sweden (Photo: Andreas Seiler)	45
Figure 4.12: The posts holding the lights in Rosvik, Sweden (Photo: Andreas Seiler)	45
Figure 4.13: The crossing area in Rosvik, Sweden. Note the two lanes one direction and one lane in the other direction separated by a wire fence (Photo: Kjell Ståhl/Road Administration, Luleå)	46
Figure 4.14: Warning signal and sign in Colville, Washington, USA (Photo: Washington Department of Transportation, Eastern Region)	47
Figure 4.15: Activated warning signals and sign at Nugget Canyon, Wyoming, USA (Photo: Bill Gribble/WYDOT)	48
Figure 4.16: Infrared sensors attached to the white posts in the FLASH system at Nugget Canyon, Wyoming, USA (Photo: Bill Gribble/WYDOT).....	48
Figure 4.17: Re-installation of the geophone system at Nugget Canyon, Wyoming, USA. The sensors were approximately 10 m (33 ft) apart at a depth of about 10 cm (4 in) below ground level to the top of the sensor. (Photo: Bill Gribble/WYDOT)	49
Figure 4.18: Infrared scope for the geophone system at Nugget Canyon, Wyoming, USA (Photo: Bill Gribble/WYDOT)	49
Figure 4.19: Microwave radar transmitters at Nugget Canyon, Wyoming, USA (Photo: Bill Moore, WYDOT).....	50

Figure 4.20: Control cabinet at Nugget Canyon, Wyoming, USA. The large boxes are the counters for the animal detections and traffic. The upper shelf holds equipment for downloading data. This equipment used AC power. (Photo: Matt Johnson, WYDOT).....	50
Figure 4.21: Video recorder system at Nugget Canyon, Wyoming, USA (Photo: Bill Gribble, WYDOT)	51
Figure 4.22: Two low-light cameras at Nugget Canyon, Wyoming, USA (Photo: Bill Gribble, WYDOT)	51
Figure 4.23: Activated warning signal and sign in Sequim, Washington, USA (Photo: Marcel Huijser, WTI-MSU)	53
Figure 4.24: Shelly Ament manually scans the frequencies of the radio collared elk in Sequim, Washington, USA (Photo: Marcel Huijser, WTI-MSU)	53
Figure 4.25: Cabinet with electronics for automated scanning for frequencies of radio collared elk and battery at one of the receiver stations in Sequim, Washington, USA (Photo: Marcel Huijser, WTI-MSU)	54
Figure 4.26: Warning signals and signs in Marshall, Minnesota, USA (Photo: Robert Weinholzer, MNDOT)	55
Figure 4.27: The sensors in the right-of-way in Marshall, Minnesota, USA (Photo: Robert Weinholzer, MNDOT).....	55
Figure 4.28: Warning signal and sign in Kootenay, British Columbia, Canada (Photo: Alan Dibb/Parks Canada)....	56
Figure 4.29: Trailer and camera in Kootenay, British Columbia, Canada (Photo: Tim McAllister).....	57
Figure 4.30: Sign indicating test section on the Indiana Toll Road, Indiana, USA (Photo: Indiana Department of Transportation, Toll Road District).....	58
Figure 4.31: Warning signal and sign on the Indiana Toll Road, Indiana, USA (Photo: Indiana Department of Transportation, Toll Road District).....	58
Figure 4.32: Pole with sensor tubes, cabinet (with circuit boards and batteries) and solar panel on the Indiana Toll Road, Indiana, USA (Photo: Indiana Department of Transportation, Toll Road District)	59
Figure 4.33: Sign indicating end of test section on the Indiana Toll Road, Indiana, USA (Photo: Indiana Department of Transportation, Toll Road District).....	59
Figure 4.34: Warning signal and sign in Wenatchee, Washington, USA (Photo: WSDOT, NorthCentral Region)....	61
Figure 4.35: The area approaching the system in Wenatchee, Washington, USA (Photo: WSDOT, NorthCentral Region).....	61
Figure 4.36: Original warning signal and sign in Yellowstone National Park, Montana, USA. A sensor is attached on the left side of the post; a cabinet with circuit boards and batteries is attached to the right side of the post. (Photo: Marcel Huijser, WTI-MSU)	62
Figure 4.37: Activated warning signal and sign with new text sign “WILDLIFE CROSSING” and solar panel in Yellowstone National Park, Montana, USA (Photo: Marcel Huijser, WTI-MSU)	63
Figure 4.38: Warning signal and sign in Thompsontown, Pennsylvania, USA (Photo: Rhonda Stankavich, PENNDOT).....	65
Figure 4.39: Pole with sensors and solar panel in Thompsontown, Pennsylvania, USA (Photo: Marcel Huijser, WTI-MSU).....	66
Figure 4.40: Warning sign and signals in Herbertville, Quebec, Canada (Photo: Ministère des Transports du Québec).....	67
Figure 4.41: Sensor and electric fence in Herbertville, Quebec, Canada (Photo: Ministère des Transports du Québec).....	67
Figure 4.42: Control cabinet in Herbertville, Quebec, Canada. The upper section of the control cabinet contains the electronics for the electric fence; the lower section contains the electronics for the sensors and warning signals. (Photo: Ministère des Transports du Québec).....	68
Figure 5.1: Animal detection system location along US Hwy 191	81
Figure 5.2: View of US Hwy 191 looking north (Photo: Marcel Huijser, WTI-MSU)	82
Figure 5.3: The grasslands and shrubs along the Gallatin River at the MT site (Photo: Marcel Huijser, WTI-MSU)	82
Figure 5.4: Animal detection system location Hwy 22/322.....	84
Figure 5.5: View of Westbound Lanes Hwy 22/322, Tompsontown, PA (Photo: Marcel Huijser, WTI-MSU)	85
Figure 5.6: View of Westbound Lanes Hwy 22/322 facing southeast, Tompsontown, PA (Photo: Marcel Huijser, WTI-MSU).....	86
Figure 5.7: Layout of animal detection system US Hwy 191 (Source: STS)	87
Figure 5.8: The sensors at one of the stations at the MT site. The cabinet contains a circuit board and batteries. (Photo: Marcel Huijser, WTI-MSU)	88
Figure 5.9: The master station at the MT site (Photo: Marcel Huijser, WTI-MSU).....	89

Figure 5.10: Activated warning signal, text sign “wildlife crossing” and solar panel at the MT site (Photo: Marcel Huijser, WTI-MSU).....	90
Figure 5.11: Sign announcing the test area at the MT site (Photo: Marcel Huijser, WTI-MSU)	90
Figure 5.12: Sign marking the end of the test section at the MT site (Photo: Marcel Huijser, WTI-MSU)	91
Figure 5.13: Data can be downloaded from the master station at the MT site through a direct connection or a radio link (Photo: Marcel Huijser, WTI-MSU).....	92
Figure 5.14: Schematic layout of the Animal Detection System Hwy 22/322.	93
Figure 5.15: A station at the PA site. The sensors and battery are located inside the grey box on top of the pole. The solar panel is attached to the side of the pole. (Photo: Marcel Huijser, WTI-MSU).....	94
Figure 5.16: A closer view of the box with sensors, battery and the solar panel (Photo: Marcel Huijser, WTI-MSU)	94
Figure 5.17: The control cabinet at the PA site (Photo: Marcel Huijser, WTI-MSU)	95
Figure 5.18: Warning signs and signals at the PA site (Photo: Rhonda Stankavich, PENNDOT)	96
Figure 5.19: Sign announcing the test area at the PA site while still at the maintenance office (Photo: Marcel Huijser/WTI-MSU)	96
Figure 5.20: Sign marking the end of the test area at the PA site while still at the maintenance office (Photo: Marcel Huijser/WTI-MSU).....	96
Figure 5.21: Michiana Contracting, Inc. assembled the animal detection system at the MDT maintenance yard in Bozeman, MT (Photo: Marcel Huijser, WTI-MSU)	98
Figure 5.22: Eagle Rock Timber installed the poles and foundations at the MT site (Photo: Marcel Huijser, WTI-MSU).....	98
Figure 5.23: Installation of the antennas, beacons, signs and solar panels at the MT site required the use of a bucket truck (Photo: Marcel Huijser, WTI-MSU)	99
Figure 5.24: Sensors at the MT site were aligned by using a scope (Photo: Marcel Huijser, WTI-MSU).....	99
Figure 5.25: Montana Department of Transportation provided traffic control at the MT site (Photo: Marcel Huijser, WTI-MSU).....	100
Figure 5.26: The wooden poles were fitted with a concrete foundation at the PA site (Photo: Marcel Huijser, WTI-MSU).....	102
Figure 5.27: Before installation the high shrubs and weeds were cut and branches of trees were removed at the PA site. (Photo: Marcel Huijser, WTI-MSU).....	102
Figure 6.1: RADS layout showing station locations, receivers, transmitters, and codes for the detection zones.....	106
Figure 6.2: Typical receiver/transmitter station showing beam tubes and mounts at an Indiana site (see Chapter 4 for details on the Indiana site) (Photo: Lloyd N. Salsman, STS)	107
Figure 6.3: Randy Moore mows vegetation in front of one of the sensors to evaluate the effect of high, moving, broad-leaved, and wet vegetation on the occurrence of false positives (Photo: Lloyd N. Salsman/STS).....	110
Figure 6.4: Detector output under frequency sweep showing nearly constant sensitivity (bottom) versus frequency (top).....	112
Figure 6.5: Center modulation for each of the 16 RADS Channels. The center modulation is used to distinguish between the individual detection beams (channels).....	113
Figure 6.6: Pima Road test site, Scottsdale (Photo: Lloyd N. Salsman, STS)	114
Figure 6.7: Detector recordings from the horse test at the site along US Hwy 191 in Yellowstone National Park, ST18.	116
Figure 6.8: The brackets holding the sensors cracked as a result of extreme temperature fluctuations at the MT site (Photo: Marcel Huijser, WTI-MSU).....	117
Figure 6.9: Snow and ice build-up on the sensors caused false positives at the MT site (Photo: Marcel Huijser, WTI-MSU).....	118
Figure 6.10: Placing a smooth surface at an angle in front of the sensors prevented snow and ice build-up on the sensors at the MT site (Photo: Marcel Huijser, WTI-MSU)	118
Figure 6.11: Randy Moore (STS) triggers the system at the MT site (Photo: Marcel Huijser, WTI-MSU).....	120
Figure 6.12: Lloyd Salsman (STS) investigating signal signatures at one of the stations at the MT site (Photo: Marcel Huijser, WTI-MSU).....	120
Figure 6.13: Tests with Ranger Gafney and her horse Buster, Yellowstone National Park, Montana (Photo: Lloyd N. Salsman, STS).....	121
Figure 6.14: Beam break signature for an animal crossing.....	122
Figure 6.15: RADS “good performance” in a clear path with little vegetation interference. ST12 (3/6) – 20 June 2004, detector - Ch2.....	124

Figure 6.16: RADS “bad performance” for a beam located over a guardrail showing vehicle multipath interference. ST12 (3/6) – 20 June 2004 Detector - Ch1	124
Figure 7.1: Schematic layout of the animal detection system and major road and landscape features at the study site (Source: STS). The numbers and letters represent the codes of the individual detection zones.....	133
Figure 7.2: Elk tracks in the right-of-way, paralleling the road at the MT site. These movements in the right-of-way may classify as "unclear" detections when interpreting the detection data of the system. (Photo: Marcel Huijser, WTI-MSU).....	135
Figure 7.3: Wolf tracks paralleling the road at the MT site (Photo: Amanda Hardy, WTI-MSU).....	136
Figure 7.4: Whisper Camel (WTI-MSU) conducted most of the snow tracking after the system at the MT site started to detect large animals reliably. She points at wolf tracks in the snow. (Photo: Marcel Huijser, WTI-MSU).....	137
Figure 7.5: Two elk tracks indicating two crossings at the MT site (Photo: Marcel Huijser, WTI-MSU).....	138
Figure 7.6: Investigation for potential blind spots. The tracks indicate where human models passed through the beam. (Photo: Marcel Huijser, WTI-MSU).....	139
Figure 7.7: Number of detections per day between 26 January and 5 March 2005.....	142
Figure 7.8: Percentage of detections per category (n = 1533) between 26 January and 5 March 2005.....	143
Figure 7.9: Hikers and cross-country skiers at the Black Butte trailhead triggered the system as well (Photo: Marcel Huijser, WTI-MSU).....	143
Figure 7.10: Snow spray from a snow plow at the MT site. Depending on the amount of snow spray, how far the snow is thrown into the right-of-way, and the location of the beam, snow spray can trigger the system. (Photo: Marcel Huijser, WTI-MSU).....	144
Figure 7.11: Number of crossing events detected by the system per hour of day for east- and westward movements between 26 January and 5 March 2005.....	144
Figure 7.12: Elk track at the MT site. The snow was not always fresh; it often had an icy crust on top which caused less than perfect tracking conditions. (Photo: Marcel Huijser, WTI-MSU).....	145
Figure 7.13: Coyote track at the MT site (Photo: Marcel Huijser, WTI-MSU).....	146
Figure 7.14: Wolf track at the MT site (Photo: Amanda Hardy, WTI-MSU).....	146
Figure 7.15: Wolf and coyote tracks at the MT site (Photo: Marcel Huijser, WTI-MSU).....	147
Figure 7.16: Number of recorded elk, coyote and wolf through snow tracking between 26 January 2005 and 28 February 2005. (See Figure 7.1 for the exact location of the detection zones.).....	148
Figure 7.17: Number of crossings based on interpretation of the detection data between 26 January 2005 and 28 February 2005. (See Figure 7.1 for the exact location of the detection zones.).....	148
Figure 7.18: Blind spots of the detection zones on the east side of the road (see Figure 7.1 for exact location).....	149
Figure 7.19: Blind spots of the detection zones on the west side of the road (see Figure 7.1 for exact location).....	150
Figure 7.20: Frequency distribution of the detection interval between consecutive detections for detections between 27 Jan 2005 and 5 Mar 2005.....	151
Figure 7.21: Frequency distribution of the duration of crossing events between 27 Jan. 2005 and 5 Mar. 2005.....	152
Figure 7.22: Frequency distribution of the detection interval between consecutive detections for the crossing events between 27 Jan. 2005 and and 5 Mar. 2005.....	153
Figure 7.23: Number of crossing events with warning lights activated during the entire crossing event, based on crossing events between 27 Jan and 5 March 2005.....	154
Figure 7.24: Jon Fleming (PennDOT) approaching one of the stations at the PA site to test the reliability of the system (Photo: Marcel Huijser, WTI-MSU).....	158
Figure 8.1: Some of the concrete foundations were in the clear zone and too high above the ground. This is the master station. The wooden post on the foreground is for the link to the land-based phone line. (Photo: Marcel Huijser, WTI-MSU).....	166
Figure 8.2: The problem with some of the concrete foundations was addressed by putting weed free soil around the posts while not blocking the drainage from the road. (Photo: Marcel Huijser, WTI-MSU).....	166
Figure 8.3: Some of the wooden poles were buried too deep. The stick indicates the upper of the three holes that serve as a break-away in case of a collision. All three holes should have been above the ground level. (Photo: Marcel Huijser, WTI-MSU).....	167
Figure 8.4: The problem with some of the break-away constructions for the wooden poles was addressed by drilling new holes at the appropriate height above the ground level. (Photo: Marcel Huijser, WTI-MSU).....	167
Figure 8.5: Curves and slopes caused the beam to shoot too high in some locations at the MT site, causing blind spots. Shown here is detection Zone 8 (see Figure 5.7 for exact location). (Photo: Marcel Huijser, WTI-MSU).....	169

Figure 8.6: Snow accumulation at the MT site. Snow accumulation may bury the sensors, potentially causing downtime for the system. (Photo: Marcel Huijser, WTI-MSU).....	173
Figure 8.7: Care should be taken that solar panels are not placed in the shade of trees or other objects, including steep slopes. The angles of the sun should be calculated during winter, as daylight is scarce and the sun is low on the horizon. (Photo: Marcel Huijser, WTI-MSU)	175
Figure 8.8: Snow may temporarily cover the solar panels. The batteries should have enough power storage to accommodate for such events. (Photo: Marcel Huijser, WTI-MSU)	175
Figure 8.9: Snow may temporarily cover warning signs and signals (Photo: Marcel Huijser, WTI-MSU)	176
Figure 8.10: The elements can be hard on the equipment and the paint (Photo: Marcel Huijser, WTI-MSU).....	178
Figure 8.11: Rhonda Stankavich (PennDOT) makes a call to the vendor at the PA site. Animal detection system projects typically require substantial coordination, sometimes from remote field locations. (Photo: Marcel Huijser, WTI-MSU).....	178
Figure 8.12: STS and MDT representatives at the MT site. After installation the system suffered from a range of technological challenges which required problem identification, problem solving and evaluation (Photo: Marcel Huijser, WTI-MSU).....	180
Figure 9.1: Costs of deer-vehicle collisions per mile per year with and without an animal detection system (ADS).....	190
Figure 9.2: Costs of elk-vehicle collisions per mile per year with and without an animal detection system (ADS) .	191
Figure 9.3: Costs of moose-vehicle collisions per mile per year with and without an animal detection system (ADS).....	191
Figure 10.1: Potential applications of animal detection systems	194
Figure 10.2: Wildlife crossing structures are often combined with wildlife fencing to guide the animals towards the crossing structure. Since some animals may walk the other way and cross the road where the fence ends, an animal detection system may be applied also. (Photo: Marcel Huijser, WTI-MSU)	195
Figure 10.3: Animal detections may reduce or prevent animal-vehicle collisions, but the poles and equipment in the right-of-way form a hazard of their own. Here a car went off the road at the MT site and just missed the pole. However, the damage to one of the sensors was about \$2000. (Photo: Jason Norman, MDT).....	196
Figure 10.4: Wildlife fences guide large animals towards the crossing area with the animal detection system. Long fence sections should have jump-outs however, to provide an escape for animals that might end up in between the fences in the right-of-way. (Photo: Bethanie Walder)	197

EXECUTIVE SUMMARY

Animal-vehicle collisions affect human safety, property and wildlife. Furthermore, the number of collisions with large wild animals has increased in North America over the last decades. The negative effects of animal-vehicle collisions and the increase in collisions prompted the initiation of this project which explored the prospects for a relatively new mitigation measure to reduce animal-vehicle collisions: animal detection systems. Animal detection systems use high tech equipment to detect large animals when they approach the road. Once a large animal is detected, warning signs are activated urging drivers to reduce the speed of their vehicles, be more alert, or both. Lower vehicle speed and increased alertness may then lead to fewer and less severe collisions with animals such as deer (*Odocoileus sp.*), elk (*Cervus elaphus*) or moose (*Alces alces*).

This report documents Phase I of the project (27 October 1999 - 31 December 2005). Phase II (1 January 2006 – 31 August 2008) will focus on the evaluation of the effectiveness of one of the two systems that were developed and installed in a roadside environment during Phase I.

This project included the following objectives:

- A. Identify existing animal detection system technologies and their vendors
- B. Select two of these systems for field tests;
- C. Locate two study sites for these field tests;
- D. Document existing conditions at the two study sites;
- E. Deploy the two systems, one at each site;
- F. Document the experiences with installation;
- G. Test the reliability of the systems;
- H. Collect post-implementation site data;
- I. Evaluate the effectiveness of the systems;
- J. Document system acceptance; and
- K. Provide advice for the future development and application.

This executive summary is structured according to these objectives.

Objective A: Identify Existing Animal Detection System Technologies and Their Vendors

For this project the researchers compiled and summarized information regarding any previous animal-detection systems and experiences with planning, installation, operation and maintenance. The researchers identified and described 34 locations that had one or more animal detection systems installed along a road (Chapter 4). This report provides information for these locations including the following:

- A general *description* of the sites and systems (Chapter 4)

- A summary of the *experiences with planning, installation, operation and maintenance* of the systems installed at the sites (see Chapter 4).
- A summary of the available data on *system reliability and effectiveness* (see Chapter 3).
- The *contact details* of 14 vendors that supplied the detection systems for the sites, as well as the contact details for two vendors that have not yet installed their animal detection system in a roadside environment (Appendix E).

Most of these sites were located in Europe (22), while the remaining sites were located in North America (12). Most of the systems used can be referred to as either “area-cover systems” or “break-the-beam systems.” Area-cover systems use passive video, active or passive infrared sensors, or active microwave radio sensors that detect movement and/or body heat within a certain radius of the sensors. Break-the-beam systems consist of transmitters and receivers that use infrared, laser or microwave radio signals. Once an animal’s body blocks or reduces the signal received by the receiver, the system is activated. Another system type uses seismic sensors that record vibrations in the ground as a result of an approaching animal. These seismic sensors are used in combination with aboveground infrared sensors. Yet another system depends on radio-collared animals that trigger the warning signals when the animals come within a certain range of receivers placed along the road.

Most of the experimental systems or prototypes of animal detection systems that were installed in North America and Europe suffered from a variety of technological difficulties following installation. In addition, major delays in obtaining an operational system were common. Technological problems are perhaps not surprising, as animal detection systems use relatively new technology for a new application under often extreme circumstances. Many systems suffered from false positives (the warning signs are activated, but there is no large animal present), false negatives (there is a large animal present, but the warning signs are not activated) and substantial downtime (the system is not able to detect large animals, e.g., due to broken equipment). A limited number of vendors and system integrators, however, have successfully addressed these difficulties, and this has resulted in reliable and/or effective animal detection systems (Chapter 4, 7 and 11). In other cases vendors and system integrators have not succeeded in producing a reliable system yet, or they have abandoned the effort altogether. To the best of the authors’ knowledge, as of February 2006 only 5 sites in North America and 15 sites in Europe had a system that is currently in operation.

Data on the effectiveness of animal detection systems are relatively scarce (Chapter 3). Most existing data relate to the effect of the warning signals and warning signs on vehicle speed. Most studies have shown relatively small reductions in vehicle speed as a result of the activated warning signals, but the response was greater when visibility and road conditions were poor (e.g., dark, rain, snow, slippery road surface). In addition, local drivers reduced the speed of their vehicles more than non-local drivers, and one study claimed that if warning signs are accompanied by mandatory or advisory speed limit reductions, greater speed reductions may be obtained. Data are even scarcer with regard to the most important parameter – the number of animal-vehicle collisions. The available data show that collisions with large wild animals can be reduced by 82% on average.

Objective B: Select Two Systems for Field Tests

The researchers and the Technical Advisory Committee selected two vendors who each developed an experimental animal detection system (Chapter 5).

- Sensor Technologies and Systems (STS) (Scottsdale, AZ) developed a microwave radio signal break-the-beam system.
- Oh DEER, Inc. (Mason City, IA) developed a microwave radio signal area-cover system.

Objective C: Locate Two Study Sites for Field Tests

The researchers and the Technical Advisory Committee selected two study sites for the two experimental animal detection systems (Chapter 5).

- The STS system was designed to detect large animals, specifically elk, at a location in Montana. The site was a 1,609 m (1 mi) long road section along US Hwy 191 (between reference posts 28 and 29) in Yellowstone National Park.
- The Oh DEER, Inc. system was designed to detect white-tailed deer at a location in Pennsylvania. The site was an 804 m (1/2 mi) long road section along Hwy 22/322, near Thompsettown, about 56 km (35 mi) northwest of Harrisburg.

Objective D: Document Existing Conditions at the Two Study Sites

The site in Montana is a two-lane road (US Hwy 191) located in the Gallatin River valley with adjacent forested slopes (Chapter 5). The north portion of the road section with the animal detection system has trees on both sides of the road within 9 m (30 ft) from the pavement. The rest of the road section is more open and has steep slopes within the right-of-way, especially on the west side of the road. There is one access road and a parking area for a trailhead within the test section. The elevation of the site is about 2,073 m (6,800 ft), and annual average snowfall is about 305 cm (120 in). Winter driving conditions include heavy snowstorms and an icy and snow packed road surface with heavy winds and temperatures well below -30 °C (-22 °F).

US Hwy 191 has two lanes that are 3.7 m (12 ft) wide with an asphalt road surface. The shoulder width varies between 0.6 and 1.2 m (2-4 ft). The clear zone is usually 6.1 m (30 ft) wide, but steep slopes are much closer to the road along certain sections. The right-of-way on the west side of the road has a steep slope for about 500 m (0.31 mi). The road has several curves within the section with the animal detection system. The speed limit is 88 km/h (55 mi/h), but the actual average vehicle operating speed is around 113 km/h (70 mi/hr). The average annual daily traffic volume (AADT) is about 2,545 vehicles with about 13% truck traffic (estimated in 2000). Traffic volume peaks in July (4,400 ADT), mostly because of tourists that visit the area.

The area is home to many large mammal species including elk (*Cervus elaphus*), moose (*Alces alces*), bison (*Bison bison*), mule deer (*Odocoileus hemionus*), white-tailed deer (*O. virginianus*), black bears (*Ursus americanus*), grizzly bears (*U. Arctos*), coyotes (*Canis latrans*) and wolves (*C. lupus*). The majority of the recorded animal-vehicle collisions in this area involve elk. The valley and surrounding slopes are an important wintering area for elk, and most elk-vehicle

collisions occur during the winter season. On average, 5.6 road-killed elk per year were reported from the 1,609 m (1 mi) long road section selected for the test site.

The site in Pennsylvania (Hwy 22/322) is a concrete four-lane divided highway (two lanes in each direction) (Chapter 5). The road cuts through a series of ridges and valleys and parallels the Juniata River. The ridges are mostly forested, while the valleys are dominated by agricultural lands, small towns and isolated farm buildings. The road section with the animal detection system cuts through agricultural lands and has shrubs and trees at the edge of and within the right-of-way and a grass strip next to the edge of the pavement. White-tailed deer are abundant in this area, and they are exposed to only limited hunting. Hwy 22/322 is a controlled access highway with a westbound off-ramp (Pfoutz Valley Rd) just before the first sensors at the southeast side of the test section and an eastbound on-ramp within the road section with the animal detection system (about halfway). The elevation of the site is about 150 m (500 ft). Annual precipitation is 762 mm (30 in). Winter driving conditions include sleet, hail, and snowstorms, and the roadway is occasionally icy.

Lane width is approximately 3.7 m (12 ft) and the median width is about 18 m (60 ft). The shoulder width varies between 1.2 and 3.0 m (4-10 ft). The clear zone is about 9.1 m (30 ft). The width of the right-of-way varies between about 30 and 35 m (100-115 ft). The right-of-way for eastbound traffic has a steep slope west of the entrance to Hwy 22/322. The road has a bridge on the south side (across the Pfoutz Valley Rd). The road also has a gentle curve and goes up a hill on the west side (downhill for eastbound traffic). The posted speed limit is 105 km/h (65 mi/h). The average annual daily traffic volume (AADT) is about 6,882 for eastbound traffic and about 6,953 for westbound traffic (13,835 for both directions combined) with about 26% truck traffic (estimated in 2002). Traffic volume peaks in June (8,044 ADT).

The majority of the recorded animal-vehicle collisions in this area involve white-tailed deer and occur in October and November; maintenance personnel from the Pennsylvania Department of Transportation (PennDOT) estimate that approximately 70 white-tailed deer carcasses are removed every year along a 1.8 km (1.1 mi) long road segment just east of Thompsettown. The animal detection system covers 805 m (0.5 mi) of this road section.

Objective E: Deploy the Two Systems, One at Each Site

The system for the location in Montana was installed in October/November 2002 (Chapter 5). The system for the location in Pennsylvania was installed in May 2004 (Chapter 5).

Objective F: Document the Experiences with Installation

The system for the location in Montana suffered from technological challenges (Chapter 6 and 8). It took two years to identify and address these problems. Nonetheless, starting in November 2004 the system started to detect elk reliably (Chapter 7). The system for the location in Pennsylvania also suffered from technological challenges, but these were not overcome by November 2004 (Chapter 7 and 8), after which the system was removed (see Objective J).

Objective G: Test the Reliability of the Systems

The system at the location in Montana was designed to detect elk and stored all detection data, including the detection zone in which the detection occurred, and a date and time stamp. System reliability was tested by evaluating system detection patterns, and by comparing snow tracking data and human crossings to the detection data saved by the system. Interpretation of the detection data suggested that at least 47% of all detections were related to large animals (e.g. deer, elk and moose) crossing the road (Chapter 7). Other detections were probably due to large animals meandering in the right-of-way or medium sized mammals (e.g., coyotes (*Canis latrans*)). These animals did not generate a clear detection pattern, and were therefore classified as “unclear.” Therefore the 47% should be regarded as a minimum estimate. The timing and direction of travel of crossing events, indicated by detections on opposite sides of the road, matched local knowledge about the behavior of the elk, suggesting that the system was able to detect large animals, specifically elk, and that the data were interpreted correctly.

The researchers also compared the spatial distribution of the crossing events with snow tracking data. The spatial distribution of the crossing events and elk tracks matched closely, again suggesting that the system was able to detect elk, and that the data were interpreted correctly. Almost 87% of all elk crossings recorded through snow tracking could be linked to a crossing event detected by the system. However, medium sized mammal species such as coyotes and wolves (*Canis lupus*) were rarely detected by the system. Furthermore, the researchers identified the presence and location of blind spots (potentially 17.8% of the total distance covered by the sensors). Blind spots were defined as locations where the system failed to detect a human crossing between the sensors. Most of the blind spots were due to curves and slopes that caused the detection beam to shoot too high above the ground.

The researchers concluded that the system detected large animals, especially elk, reliably, but the system did not detect all elk that approach the road, e.g., because of blind spots resulting from design errors. The exact location of the blind spots and potential remedies will be investigated during Phase II of this project (1 January 2006 – 31 August 2008). Once the blind spots have been addressed and the warning signs have been attached, the effectiveness of the system will be investigated, both with regard to a potential reduction in vehicle speed and a potential reduction in collisions with large animals.

In addition to evaluating the reliability, the researchers used the detection data saved by the system to calculate how long the flashing warning lights would be activated in a day, and how long it took for a crossing event to be completed (Chapter 7). This work resulted in guidance on a specific system parameter, i.e., for how long should the flashing warning lights be activated after a detection has occurred. Before these analyses the warning time after a detection (3 min) was based on a “best guess” rather than actual data.

The total time that the flashing warning lights would have been activated was estimated at 1 h 13 min per day (5% of the time), indicating that the animal detection system resulted in relatively time specific warning signals for drivers. Most crossing events (72.6%) were completed within 3 min, and the median duration of a crossing event was 1 min 29 sec. If the warning signs would be activated for 3 min after the last detection, the signs would have been continuously activated for 88.1% of all detection intervals (i.e., time between consecutive detections) during crossing

events. Similarly, 78.1% of all crossing events would have had the warning signs continuously activated while the crossing was in process. The researchers concluded that a 3 min activation period for the warning signs after a detection has occurred appeared to be a good balance between keeping the signs turned on while animals (i.e., elk) are in the process of crossing the road, and not presenting drivers with activated warning signs that may no longer be strongly associated with large animals on or near the road, which could erode local driver confidence in the activated warning signs.

The system at the location in Pennsylvania failed to detect humans used as a model for white-tailed deer reliably (Chapter 7). This, combined with other factors (see Objective J), caused the system at the Pennsylvania site to be removed in January 2005.

Objective H: Collect Post-Implementation Site Data

The road and right-of-way characteristics did not change because of the installation of the animal detection systems. However, the following factors may have changed after the installation of the two systems: traffic volume, animal species present, changes in herd size, and number of animal-vehicle collisions. For the site in Montana, these potential changes will be reported on in Phase II of the project (1 January 2006 – 31 August 2008). These data have not been and will not be collected for the site in Pennsylvania, since the system was removed from that location.

Objective I: Evaluate the Effectiveness of the Systems

The effectiveness of the system at the site in Montana will be evaluated in Phase II of the project (1 January 2006 – 31 August 2008). System effectiveness will not be evaluated at the site in Pennsylvania, since the system was removed from that location. System effectiveness parameters include a potential reduction in vehicle speed and a reduction in collisions with large animals, especially elk.

Objective J: Document System Acceptance

Although reliability of the system in Montana was eventually established, the overall acceptance of the system must nonetheless be characterized as “poor,” at least up until December 2005 (Chapter 7). The project partners had concerns about the reliability of the system, particularly the blind spots; and both the host agency and the public shared concerns about the obtrusive nature and size of the equipment. In the future, animal detection instrumentation will need to either be “invisible” to the public or blend in with the surrounding landscape better if deployed in settings where aesthetics are a major concern. More data on system acceptance will be collected in Phase II of the project (1 January 2006 – 31 August 2008).

The system in Pennsylvania was not accepted by the host agency (Chapter 7). The main reasons were the unreliability of the system and poor communication by the vendor. These two factors caused the system at the Pennsylvania site to be removed in January 2005.

Objective K: Provide Advice For the Future Development and Application

Cost Benefit Analyses

The researchers calculated the costs and benefits associated with the installation and use of animal detection systems (Chapter 9). Only monetary values were included for this analysis, but it was recognized that there are values associated with animal-vehicle collisions that may not readily translate into a monetary value or that one may consider inappropriate. Nevertheless, the analysis provided insight as to whether animal detection systems are a wise investment, at least from a monetary perspective. The cost-benefit analysis suggested that the benefits of animal detection systems can be greater than the costs at locations that have an average of at least 5 deer-, 3 elk- or 2 moose-vehicle collisions per mile road length per year. This suggests that animal-detection systems have the potential to be applied on a wide scale.

Potential Applications of Animal Detection Systems

Animal detection systems are usually installed at locations that have a history of animal-vehicle collisions, especially with large ungulates such as deer, elk or moose. The systems are primarily installed because of human safety and property damage concerns. However, animal detection systems may also be installed at locations where a current or planned habitat linkage zone for large animals intersects with a road (Chapter 10).

Animal detection systems can be installed as a standalone mitigation measure, but they can also be combined with other mitigation measures such as limited or extensive wildlife fencing and/or wildlife crossing structures (i.e., underpasses or overpasses) (Chapter 10). With extensive wildlife fencing, animal detection systems can be installed at fence ends or gaps in the fence. Limited wildlife fencing can be used to funnel the animals toward a road section with an animal detection system. This increases the length of the mitigated road section at a potentially lower cost. Fence installation and maintenance costs, however, may be high as well. Finally, animal detection systems may be deployed along frontage roads adjacent to a wildlife crossing structure on the parallel freeway.

For this report the researchers also summarized the pros and cons of animal detection systems versus wildlife crossing structures (i.e., underpasses or overpasses) in combination with wildlife fencing (Chapter 10).

Pros

- Animal detection systems have the potential to provide wildlife with safe crossing opportunities anywhere along the mitigated roadway, but wildlife crossing structures are usually limited in number, and they are rarely wider than about 50 m (55 yd).
- Animal detection systems are less restrictive to wildlife movement than fencing or crossing structures. They allow animals to continue to use their existing paths to the road or to change them over time.
- Animal detection systems can be installed without major road construction or traffic control for long periods.

- Animal detection systems are likely to be less expensive than wildlife crossing structures, especially once they are mass produced.

Cons

- Currently, animal detection systems only detect large animals (e.g., deer, elk and/or moose). Relatively small animals are not detected, and drivers are not warned about their presence on or near the road.
- Wildlife crossing structures have the potential to provide cover (e.g., vegetation, including living trees, tree stumps) and natural substrate (e.g., sand, water) allowing better continuity of habitat.
- Some types of animal detection systems are only active in the dark and animals that cross during the daylight may not be protected.
- Animal detection systems usually require the presence of poles and equipment in the right of way, sometimes even in the clear zone, presenting a safety hazard of their own.
- Animal detection systems may substantially reduce the number of animal-vehicle collisions, but since they allow large animals to cross the road at grade, they will never completely eliminate animal-vehicle collisions.
- Animal detection systems can be aesthetically displeasing.
- Wildlife crossing structures are likely to have greater longevity and lower maintenance and monitoring costs.

Advice for Future Animal Detection System Projects

The lessons learned from this project, including the experiences with the development and installation of two experimental animal detection systems in a roadside environment, have been documented in this report (Chapter 8). These lessons have been translated into advice for future projects that aim to install and operate an animal detection system along a road (Chapter 11). This advice may be helpful, as the number of locations with an animal detection system seems to be growing rapidly. Currently there are seven sites in North America and 20 sites in Europe, for which an animal detection system is in the planning phase (as of February 2006) (Chapter 4). For transportation and natural resource management organizations that are interested in the deployment of an animal detection system, the following steps are recommended:

- Define the problem to be solved (e.g., target species, parameters of effectiveness), and identify the requirements of the transportation agency (e.g., desired level of effectiveness, maximum maintenance effort) and the site specific conditions and requirements (e.g., slopes, curves, vegetation, minimum distance from the road, vegetation management restrictions). Ideally this should be the outcome of a regional prioritization identifying current animal-vehicle collision hot spots or habitat linkage zones.
- Obtain a current overview of all known mitigation measures that may address the problem, that meet the requirements of the transportation agency, and that match the site specific conditions and requirements. Determine whether an animal detection system is indeed the most appropriate mitigation measure. While animal detection systems can be applied as a standalone mitigation measure, animal detection systems can also be used in

combination with other mitigation measures such as wildlife fencing and wildlife crossing structures.

- Obtain a current overview of all known animal detection systems, their vendors, and the experiences with system reliability, system effectiveness and other aspects of operation and maintenance as well as other lessons learned.
- Select a system that meets the requirements of the transportation agency and that matches the site specific conditions and requirements. Not all reliable or effective systems may be suitable. Ideally all reliable and effective systems should meet minimum standards for system reliability. These standards have not been determined at this time; therefore, no system has yet been tested with regard to such minimum requirements. If reliability data are not available, consider a two-phased contract with the vendor, with a smaller temporary test installation prior to a more permanent roadside installation.
- Make a realistic risk assessment for potential delays, technological challenges, the financial situation of a vendor, and political support for the project. If the outcome of the assessment is not acceptable, consider alternative mitigation measures.
- Take the lessons learned (see Chapter 8) into account when preparing project descriptions, contracts and other agreements with vendors, installation contractors, researchers, and other project partners.
- Prepare for technological difficulties and substantial delays following the installation of an animal detection system. It may take many months or several years before an animal detection system becomes operational. Even systems that are initially successful will fail without proper monitoring and maintenance. Also prepare for potential abandonment of the project and system removal.
- Document and publish the experiences with the project, including lessons learned during design and planning, installation, and operation and maintenance, regardless of whether the project resulted in a reliable or effective system. This provides essential guidance for similar projects in the future.
- Document and publish data on system reliability and system effectiveness, regardless of whether the project resulted in a reliable or effective system. This will allow transportation agencies to compare the reliability and effectiveness of animal detection systems to other mitigation measures and to select the most reliable and effective animal detection systems.

Furthermore, the researchers formulated the most important remaining (research) needs relating to the development, use and effectiveness of animal detection systems:

- The availability of a high level concept of operations for animal detection systems to show how the systems may work in the future and to provide guidance to the further development of animal detection systems.
- The development of smaller and less obtrusive animal detection systems. This is not only required to address landscape aesthetics concerns, but smaller systems also reduce the hazard for people in vehicles that run off the road.
- The availability of guidelines to integrate animal detection systems into national Intelligent Transportation Systems (ITS) architecture and standards. This should provide guidance for the further development of animal detection systems.

- The availability of comparable reliability data for different systems, preferably obtained under similar circumstances at a controlled access environment. This should allow employees from transportation agencies to select the most reliable systems.
- The establishment of minimum standards for the reliability of animal detection systems. This should allow employees from transportation agencies to select systems that meet certain minimum standards for system reliability. It also provides guidance to vendors and system integrators for the future development of animal detection systems.
- Insight into the most effective warning signs and signals, appropriate distance between warning signs and signals, and standards for warning signs and signals.
- Continuation of the collection, analyses and interpretation of data on the experiences with planning and design, installation, operation and maintenance and evaluation of animal detection systems.
- Continuation of the collection, analyses and interpretation of data on system effectiveness from systems that have been deployed in a roadside environment and that are operating reliably.

Despite encouraging data on system reliability and effectiveness, the installation and use of animal detection systems should still be regarded as research projects rather than deployments of a proven mitigation measure. Finally, animal detection systems do not automatically replace more traditional types of mitigation measures (e.g., wildlife underpasses and overpasses in combination with wildlife fencing). However, the limited data on the reliability and effectiveness of animal detection systems do suggest that they may become a valuable and widely applied tool to help reduce animal-vehicle collisions.

Accomplishments and Rationale for Phase II

The members of the Technical Advisory Committee (TAC) (see Appendix A) summarized the accomplishments of Phase I of the project (27 October 1999 - 31 December 2005) in June 2005:

- This project provided a forum for 15 DOTs and FHWA to share experiences and to direct research related to the reduction of animal-vehicle collisions, specifically with regard to a relatively new mitigation measure: animal detection systems. The 15 DOTs and FHWA learned that animal-vehicle collisions are a growing problem in many states and that many states face similar problems. While some mitigation measures have already been shown to be effective, the effectiveness of other measures is disputed or, in the case of animal detection systems, insufficiently known. There is a need for a wide variety of potential mitigation measures to choose from, as the local conditions and requirements vary between locations that require mitigation measures. The states learned from each other's experiences and discussions, including topics such as the hidden costs of animal-vehicle collisions, disposal costs (\$30-80 per carcass), worker compensation, potential exposure to contagious diseases, and legal concerns (wildlife management regulations, solid waste regulations).
- The DOTs and FHWA now have access to the contact details of vendors of animal detection systems throughout North America and Europe. This makes it easier to identify and contact vendors that have been shown to be able to produce a reliable and/or effective animal detection system.

- The DOTs and FHWA learned that some animal detection systems can reliably detect large animals and that (depending on road and weather conditions, signing and other factors) lower vehicle speed and a substantial reduction in animal-vehicle collisions can be obtained. This information was not available or generally accessible before the start of the project.
- The DOTs and FHWA learned that there are currently no standards for the reliability and other performance criteria for animal detection systems. There are also no standards for warning signs and signals. Generally accepted minimum criteria for animal detection systems and signing standards are needed however, especially with regard to potential liability in case of an animal-vehicle collision after system installation.
- The project resulted in one animal detection system that detects large animals reliably (manufactured by Sensor Technologies and Systems, installed at the site in Montana). However, due to design errors, there were two substantial blind spots in the road section covered by the system. The concept of the technology has been shown to work though.
- The project resulted in concrete ideas to design and build a second generation system (by STS) that would have much smaller dimensions (landscape aesthetics, reduced power requirements, reduced costs for solar panels) and that would have a more reliable and robust communication system. Hence the project gave direction to the improvement of an experimental animal detection system.
- The DOTs and FHWA learned that animal detection system projects should still be approached as research projects rather than deployment projects. It is essential to clearly formulate the goals and expectations of an animal detection system project and stress that they relate to research, rather than deployment alone.
- The DOTs and FHWA learned that studies in a real roadside environment are essential, but that they can also be challenging and complex.
- The DOTs and FHWA now have access to up-to-date information related to experiences with regard to system planning, design, installation, operation and maintenance and evaluation from all known locations throughout North America and Europe. This includes detailed information with regard to the experiences on the two study locations and two experimental animal detection systems selected for this project in MT and PA. The lessons learned have been documented and will greatly benefit future animal detection system projects.
- The DOTs and FHWA learned that animal detection systems have the potential to become a reliable and cost-effective mitigation measure that can be added to their “toolbox.” However, further research is required before animal detection systems can be deployed and expected to become operational and effective shortly after system installation.
- The DOTs and FHWA learned what questions still need to be addressed before animal detection systems may qualify as a proven and cost-effective mitigation measure (see Chapter 11).
- The DOTs and FHWA learned that there is great interest from the public with regard to animal-vehicle collisions and that media attention, particularly with regard to animal detection systems, has been considerable and generally favorable.

In addition, the members of the TAC summarized the benefits of continuing the project at the location in Montana (Phase II of the project (1 January 2006 - 31 August 2008)):

- The warning signs and signals can be attached/activated under the following conditions: 1) the blind spots of the system at the Montana site are addressed; 2) the brackets for the sensors are replaced; 3) the communication links, especially with station 3, are improved; 4) the Montana Department of Transportation (MDT) accepts ownership of the system and responsibility for operation and maintenance; and 4) Yellowstone National Park approves these efforts. This would allow for the collection of system effectiveness data, including potential reduction in vehicle speed and potential reduction in animal-vehicle collisions. In addition, the researchers would be able to interview drivers with regard to their opinion of and experiences with the animal detection system. This would allow the researchers to not only collect data on the reliability of the experimental animal detection system, but also on its effectiveness. Hence the researchers would be able to do what was originally intended; i.e., to fully investigate the reliability and effectiveness of the experimental animal detection system and make recommendations for future research and deployments, particularly with regard to this experimental animal detection system.
- Data on system effectiveness for animal detection systems are currently extremely scarce. However, these data are essential to further investigate whether animal-detection systems in general are effective in reducing animal-vehicle collisions and whether they should indeed be considered as a potential mitigation measure, regardless of the exact technology and vendor.
- More data on the costs for operation and maintenance are needed. This would allow for a better insight in the cost-effectiveness of animal-detection systems and how they compare to other mitigation measures.

The members of the TAC also summarized the costs of discontinuing the project at the location in Montana and not entering Phase II of the project (1 January 2006 - 31 August 2008):

- An experimental animal detection system that detects large animals reliably was developed but not tested with regard to system effectiveness. The problem of animal-vehicle collisions is still present and growing though, and there is a need for more and effective mitigation measures to choose from as local conditions and requirements for problem locations vary. The reliability and effectiveness data for animal detection systems thus far are encouraging and call for continued efforts rather than the abandonment of the effort. If the effort were abandoned, one could consider the money spent thus far as a loss; not because the concept of animal detection systems in general or the experimental animal detection system failed to work, but simply because the required research was not fully pursued.
- Data on the effectiveness of animal detection systems are extremely scarce. The field of animal detection systems has a great need for more and better data on the effectiveness of animal detection systems under a variety of conditions. These data can only be acquired by having reliable animal detection systems in place in real roadside environments and by collecting data on system effectiveness. Reliable animal detection systems that are operational with the warning signs and signals attached, and that are monitored for system effectiveness are extremely scarce. The removal of any reliable animal detection

system from a real roadside environment is a serious loss and delays the further development and application of animal detection systems. In this case, the abandonment of the further evaluation of the experimental animal detection system at the Montana site may block further research and deployment of animal detection systems in North America for the coming years or longer.

Considering the above points, the TAC decided to continue the project and to enter Phase II (1 January 2006 - 31 August 2008). Going forward with Phase II, however, is contingent upon the conditions stated above (first bullet under the benefits of continuing the project). If these conditions can be satisfactorily met, upon the approval of the TAC the second phase can proceed.

1.0 INTRODUCTION

Authors: Marcel P. Huijser and Patrick T. McGowen
Western Transportation Institute, Montana State University
P.O. Box 174250, Bozeman, MT 59717-4250 (e-mail: mhuijser@coe.montana.edu)

1.1 BACKGROUND

Animal-vehicle collisions affect human safety, property and wildlife. In the United States the total number of deer-vehicle collisions was estimated at more than 1 million per year (*Conover, et al. 1995*). These collisions were estimated to cause 211 human fatalities, 29,000 human injuries and over one billion dollars in property damage a year (*Conover, et al. 1995*). Similar figures are available from Europe, where the annual number of collisions with ungulates was estimated at 507,000, causing 300 human fatalities, 30,000 human injuries and over one billion dollars in material damage (*Groot Bruinderink and Hazebroek 1996*). These numbers have increased even further over the last decade (*Hughes, et al. 1996; Romin and Bissonette 1996; Knapp, et al. 2004; Khattak 2003; Tardif and Associates Inc. 2003*).

In most cases the animals die immediately or shortly after the collision (*Allen and McGullough 1976*). In some cases it is not just the individual animals that suffer. Road mortality may also affect some species on the population level (*van der Zee, et al. 1992; Huijser and Bergers 2000*). Some species may even be faced with a serious reduction in population survival probability as a result of road mortality, habitat fragmentation and other negative effects associated with roads and traffic (*Proctor 2003*). In addition, some species also represent a monetary value that is lost once an individual animal dies (*Romin and Bissonette 1996; Conover 1997*).

Historically, animal-vehicle collisions have been addressed through signs warning drivers of potential animal crossings. In other cases, wildlife warning reflectors, mirrors or wildlife fences have been installed to keep animals away from the road (*de Molenaar and Henkens 1998; Clevenger, et al. 2001*). However, conventional warning signs appear to have only limited effect because drivers are likely to habituate to them (*Pojar, et al. 1975*). Wildlife warning mirrors or reflectors may not be effective (*Reeve and Anderson 1993; Ujvári, et al. 1998*). Wildlife fences isolate populations. Wildlife fencing has been combined with wildlife crossing structures to address these limitations; but, primarily due to their relatively high cost, such crossing structures are limited in number and width (*Foster and Humphrey 1995; Clevenger, et al. 2002*).

For this project The Western Transportation Institute at Montana State University (WTI-MSU) explored the prospects for a relatively new mitigation measure: animal detection systems. Animal detection systems detect large animals (e.g., deer (*Odocoileus sp.*), elk (*Cervus elaphus*) and/or moose (*Alces alces*)) as they approach the road. When an animal is detected, signs are activated that warn drivers that large animals may be on or near the road at that time.

There have been numerous projects that included the installation and evaluation of the effectiveness of animal detection systems (reviews in *Farrell, et al. 2002; Robinson, et al. 2002; Huijser and McGowen 2003*). So far, only a couple of these animal detection systems have been studied with regard to system reliability and system effectiveness. Examples include the following:

- area cover systems in Switzerland (Kistler 1998; Romer and Mosler-Berger 2003; Mosler-Berger and Romer 2003);
- area cover systems in Finland (Muurinen and Ristola 1999; Taskula 1999);
- systems in Wyoming (Gordon, et al. 2001; Gordon and Anderson 2002; Gordon, et al. 2004); and
- the area cover system in Kootenay National Park, Canada (Kinley, et al. 2003).

Most systems, however, have never been evaluated properly; and the information with regard to those systems remains anecdotal at best. Nevertheless, the information that is available shows that, depending on road and weather conditions and reduced speed limits, the warning signs can cause drivers to reduce their speed (*Muurinen and Ristola 1999; Kistler 1998; review in Huijser and McGowen 2003; Kinley, et al. 2003*). Warning lights may also result in more alert drivers (*Green 2000*), which can potentially lead to a substantial reduction in stopping distance: 20.8 m at 88 km/h (68 ft at 55 mi/h) (*Huijser and McGowen 2003*). Finally, research from Switzerland has shown that animal detection systems can reduce ungulate-vehicle collisions by as much as 81-82% (*Kistler 1998; Romer and Mosler-Berger 2003; Mosler-Berger and Romer 2003*). These results are encouraging, but there remains much to be learned about the installation, operation and maintenance, and the reliability and effectiveness of animal detection systems (*Huijser 2003*).

1.2 STUDY OBJECTIVES

This study aimed to integrate the available information on animal detection systems and add to it through the results and experiences with two experimental animal detection systems at two study locations in the United States. The specific objectives for this study were to:

- a. Identify existing animal detection system technologies and their vendors;
- b. Select two of these systems for field tests;
- c. Locate two study sites for these field tests;
- d. Document existing conditions at the two study sites;
- e. Deploy the two systems, one at each site;
- f. Document the experiences with installation;
- g. Test the reliability of the systems;
- h. Collect post-implementation site data;
- i. Evaluate the effectiveness of the systems;
- j. Document system acceptance; and
- k. Provide advice for the future development and application.

1.3 PROJECT FUNDING

This work was funded by the Federal Highway Administration and 15 departments of transportation through a pooled fund study (SPR-3(076)) (NCHRP 2002). The participating departments of transportation were: Alaska Department of Transportation and Public Facilities, and the Departments of Transportation of California, Indiana, Iowa, Kansas, Maryland, Montana, Nevada, New Hampshire, New York, North Dakota, Oregon, Pennsylvania, Wisconsin, and Wyoming. Their contributions totaled \$945,000 (Figure 1.1). Oregon Department of Transportation (ODOT) administered these funds for \$30,000 and managed a \$915,000 contract with the Western Transportation Institute at Montana State University (WTI-MSU) to conduct the study.

Additional funds (\$120,000) came from the WTI-MSU to help cover the installation and project extension costs at the Montana study site (Figure 1.1). This brought the total project budget up to \$1,065,000.

Pennsylvania Department of Transportation (PennDOT) estimated that an additional \$130,000 was spent by PennDOT on coordination, engineering plans, installation, and efforts to help identify and address problems after installation for the Pennsylvania study site (Dennis Prestash, PennDOT, personal communication, 18 November 2004). In addition, the Montana Department of Transportation (MDT) spent an unknown amount of funds on coordination, support for installation, and efforts to help identify and address problems after installation a study site (MT). However, these contributions of PennDOT and MDT were not part of the funds administered by ODOT or WTI-MSU and were excluded from Figure 1.1.

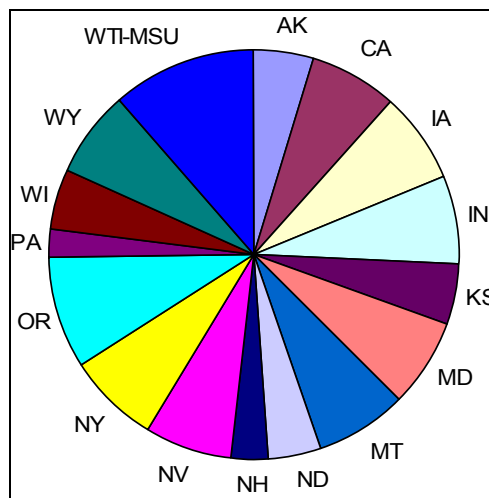

Figure 1.1: Financial contributions (Total = \$1,065,000)

1.4 STRUCTURE OF THE REPORT

The background, rationale, objectives and funding for the study are described in **Chapter 1**, the introduction.

Chapter 2 describes a high level concept of operations for road-based animal detection systems and visualizes how they could or should interact with drivers, transportation agencies, natural resource management agencies, system manufacturers and installation contractors. Chapter 2 also describes two mechanisms through which fewer and less severe collisions could be obtained: through increased driver alertness and through reduced vehicle speed. In addition, the two main types of technology for animal detection systems are described.

Chapter 3 formulates the main research questions and research methods with regard to the reliability and effectiveness of animal detection systems, defines the measures of effectiveness, and summarizes current understanding of the factors that may influence system effectiveness based on a review of the available literature.

Chapter 4 lists all road-based animal detection systems in North America and Europe known to the authors with a description of their main characteristics and a review of each system with regard to installation, operation, and maintenance experiences.

Chapter 5 chronicles the two study sites (MT and PA) and the two experimental animal detection systems that were selected for a field test.

Chapter 6 addresses the post installations to the animal detection system at the MT study site.

Chapter 7 focuses on the reliability and system effectiveness tests as well as the acceptance of the animal detection systems at the two study sites (MT and PA).

Chapter 8 reviews the challenges encountered and the experiences and lessons learned during the planning, design and installation phase, and the operation and maintenance of the systems. This discussion also draws from the experiences with other animal detection system projects (see Chapter 4).

Chapter 9 explores the cost-benefit aspects of animal detection systems.

Chapter 10 examines the pros and cons of animal detection systems versus other mitigation measures and gives examples of how animal detection systems could be used, either as stand alone mitigation measures or in combination with other mitigation measures.

Chapter 11 draws conclusions, and makes recommendations for future research, development and investment in animal detection systems and their use in a roadside environment.

2.0 ANIMAL DETECTION SYSTEMS: PRINCIPLES

Author: Marcel P. Huijser

Western Transportation Institute, Montana State University

P.O. Box 174250, Bozeman, MT 59717-4250 (e-mail: mhuijser@coe.montana.edu)

2.1 SYSTEMS CONCEPTS STUDIED

This study deals with animal detection systems based along the road only. It does not deal with animal warning systems or vehicle-based detection systems. Animal warning systems detect vehicles or trains, not the animals. Once a vehicle or train is detected large animals are alerted through a range of audio and visual signals from stations placed in the right-of-way. (For details and discussion see *Bushman, et al. 2001; Huijser and McGowen 2003; Hunin 2005*). Vehicle-based systems (e.g., *Bendix 2002; General Motors 2003; Hirota, et al. 2004; Honda 2004*) were not part of this study either. Vehicle-based systems only inform drivers in vehicles equipped with such a detection system. Road-based animal detection systems, however, are designed to inform all drivers, regardless of what equipment their vehicle may or may not have.

2.2 CONCEPT OF OPERATION

A road-based animal detection system consists of two parts: one part detects large animals as they approach the road, and the other part warns the drivers after detection has occurred (Figure 2.1). A transportation agency or natural resource management agency usually takes the initiative for site- and species-specific mitigation measures. Site selection is often based on accident reports and road-kill data for large animal species. The transportation agency and natural resource management agencies then decide on the appropriate approach; in this case an animal detection system. After a vendor is selected, an animal detection system is designed, built, and delivered by the vendor. An installation contractor then puts the system in place.

Once the system is installed and working according to the agreed upon specifications, the transportation agency may operate and maintain the system. In some cases natural resource management agencies may assist with checking up on the system. Currently most systems have to be checked at the site regularly to verify that the system is indeed operating correctly. In some cases there is remote access to the detection data and system diagnostics through land-based phone lines, or cellular or satellite phone. In the future there may be algorithms in place that screen the data continuously for unusual patterns that may indicate that there is a problem with the system or parts thereof. Once a problem with the system is detected, a person may be notified through an automated system. Figure 2.1 shows the concept of operations for animal detection systems. Arrows indicate the direction of output and processes. Solid lines indicate output and processes that exist already. Dotted lines indicate output and processes that may be developed in the future.

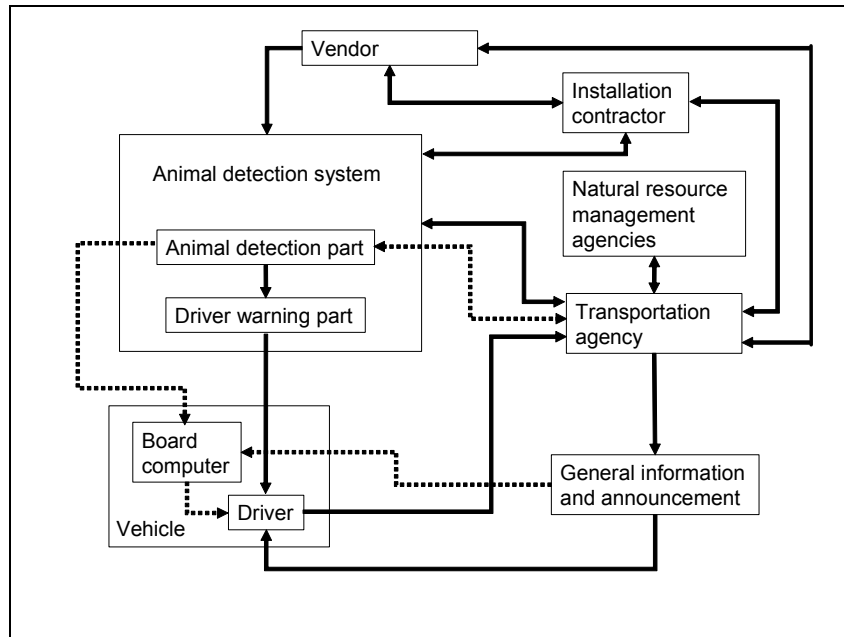

Figure 2.1: Concept of operations

The transportation agency provides information to the traveling public about the purpose and the location of the animal detection system. This information should be provided just before drivers get to the area covered by the animal detection system. Road signs and highway advisory radio messages are the most obvious ways to deliver this information to the driver. When approaching the animal detection system a driver may be confronted with an activated warning signal indicating that a large animal has been detected and is present on or near the road at that time.

In the future the information about the purpose and the location of the animal detection system may also be delivered to an on-board computer inside the vehicle. The information would be provided as soon as the vehicle gets within a certain radius of the animal detection system. This procedure would require a two-way GPS-based communication system. The warning signal may also be delivered to an on-board computer inside the vehicle.

2.3 SYSTEM RELIABILITY AND EFFECTIVENESS

In order to reduce the number of animal-vehicle collisions, animal detection systems need to detect animals reliably, and they also need to influence driver behavior so that drivers can avoid a collision.

Most animal detection system technologies are vulnerable to ‘false negatives’ and ‘false positives’ (see Chapter 4). False negatives occur if an animal approaches, but the system fails to detect it. False positives occur if the system reports the presence of an animal, but there is no animal present. Numerous false positives may result in drivers regarding the system no differently than a permanently flashing warning light not connected to sensors. False negatives

should be avoided or kept to an absolute minimum, as drivers expect an animal detection system to detect all or nearly all large animals that approach the road. False positives should also be minimal, but it is more acceptable to have a few false positives than a few false negatives. Nevertheless, it is important that animal detection systems are reliable, as drivers are expected to respond to the warning signals.

Once an animal detection system reliably detects the target species and the warning signals and signs are activated, driver response determines how effective the system ultimately is in avoiding or reducing animal-vehicle collisions. Figure 2.2 splits driver response into two components: increased driver alertness and lower vehicle speed.

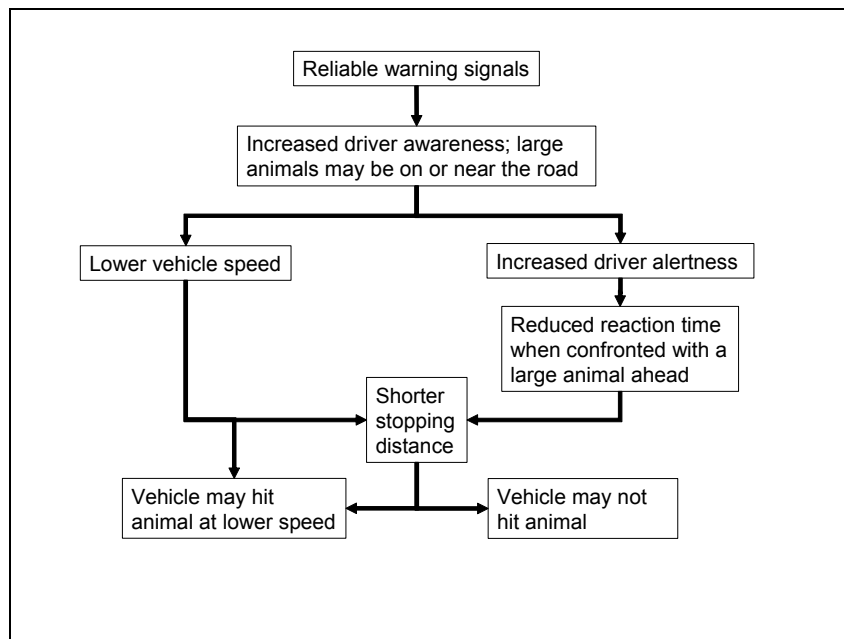

Figure 2.2: Warning signals and driver response

A higher state of alertness of the driver, lower vehicle speed, or a combination of the two can result in a reduced risk of a collision with the large animal and less severe collisions. A reduced collision risk and less severe collisions mean fewer human deaths and injuries and lower property damage. In addition, fewer large animals are killed or injured on the road without having been restricted in their movements across the landscape and the road. Furthermore, fewer large dead animals will have to be removed, transported, and disposed of by road maintenance crews.

2.4 SYSTEM TECHNOLOGIES

Animal detection systems use sensors to detect large animals as they approach the road. The technology for most animal detection systems is either based on “area cover sensors” or “break-

the-beam sensors” (*Huijser and McGowen 2003*). Area cover sensors detect large animals within a certain range of a sensor. Area coverage systems can be active or passive. Passive systems detect animals by only receiving signals. The two most common are passive infrared and video detection. These systems require algorithms that distinguish between e.g., moving vehicles with warm engines and moving pockets of hot air and movements of large animals. Active systems send a signal over an area and measure its reflection. The primary active area coverage system is microwave radar.

Break-the-beam sensors detect large animals when their body blocks or reduces a beam of infrared, laser or microwave radio signals sent by a transmitter and received by a receiver. There are other techniques that do not use area cover sensors or break-the-beam technologies, but these rather unique systems are discussed in Chapter 4.

3.0 RESEARCH QUESTIONS, METHODS AND CURRENT UNDERSTANDING OF SYSTEM RELIABILITY AND EFFECTIVENESS

Authors: Marcel P. Huijser and Patrick T. McGowen
Western Transportation Institute, Montana State University
P.O. Box 174250, Bozeman, MT 59717-4250 (e-mail: mhuijser@coe.montana.edu)

3.1 SYSTEM RELIABILITY

The purpose of animal detection systems is to detect animals when they approach the road. Therefore false negatives and false positives should not occur or should be kept to an absolute minimum. It is equally important that animal detection systems have minimal ‘downtime,’ due to broken parts, maintenance, weather conditions, or other factors. Despite the obvious nature of these basic requirements, many animal detection systems are still in the experimental stage and suffer from a variety of such problems (see also Chapter 4). The following paragraphs list methods that could be used to quantify potential false negatives, false positives, and downtime.

3.1.1 False negatives

Actively trigger the system: A domesticated individual of the species for which the animal detection system was designed (‘target species’) could be used to see if the system indeed records the presence of an individual animal when it approaches the road. However, a domesticated species of similar size or humans may have to be used as a model of the ‘target species.’ The individual should enter the detection zone at multiple locations, for example at 10 or 20 m intervals. Knowing when and where the system is intentionally triggered, the detection data can be checked to see if the triggering events are indeed recognized by the system or whether ‘blind spots’ occur. Since the ability of an animal detection system to detect the target species or models may depend on the conditions, the systems should be tested in different seasons and at different times of the day (e.g., different weather conditions, light conditions, stages of vegetation growth).

Incidental observations: People that travel the road regularly, such as road maintenance personnel, police officers, and local commuters can contribute to investigating system reliability by reporting sightings of animals on the road in the road section concerned. They should record the date, time, exact location (to provide a link to the detection zone), species, and if possible the number of individuals and the direction of the animal movements. These reports can then be compared to detections recorded by the system to identify potential false negatives. The reports can also provide insight in how well different species, including ‘non-target species,’ are detected. The general public could be included with this effort through various media. For example, signs could be posted in the vicinity of the system to encourage the traveling public to tune in to an AM radio to learn about its purpose and how to report animal sightings in the area

of the system by calling an automated answering service from their cell phones shortly after their observations. The reliability of observations provided by the public should be carefully evaluated, but involving the public is also likely to increase driver awareness of the system and driver awareness of potential animal crossings.

Tracking: Sand tracking beds that are at least 2.4 m (8 ft) wide, between sensors, can record tracks of many large animal species, including deer and bear species and allow for comparison of tracking events to detections recorded by the system (see also “Incidental observations”). The presence of a set of tracks indicates that an individual of that species must have passed through the detection zone since the bed was last checked and all previous tracks erased. Opportunistic snow tracking is also an option in certain areas when snow is on the ground. However, with both sand track beds and snow tracking it is important to evaluate whether tracks could have been erased since the last tracking session, e.g., because of rain, wind, additional snowfall, evaporation or snow melt, or whether a track was left at all, e.g., due to frozen sand or a hard ice crust on top of the snow.

Monitor with IR camera and recording system: It is possible to record animals passing through a detection zone using a camera and recording system with date and time stamp. It would be advantageous to have an infrared (IR) system (night vision), preferably with the capability to mark the moments when animals enter the image. The latter would greatly reduce the time required to review the images. The images recorded by the camera system can then be compared to the detections recorded by the detection system (see also “Incidental observations”). However, the range of such camera systems is often limited and it may require multiple camera systems to cover the entire road length with an animal detection system, which may be cost-prohibitive.

3.1.2 False positives

Observation sessions: If there are numerous detections, and if there is a suspicion that many may be false, the detection zone concerned could be observed for a certain period to see whether an individual of the ‘target species’ is really there when the system is triggered. Depending on the length of the section, this could require several observers to ensure that no individual of the ‘target species’ is missed. Nevertheless, the problem remains that those moments cannot be reassessed to verify if there was really no such animal present in the detection zone at the time of a detection. An event could have happened in a blink of an eye.

Monitor with IR camera and recording system: This would accomplish the same as observation sessions, but now the images can be reviewed to verify whether there was indeed no individual of the ‘target species’ present. There may also be an opportunity to identify the cause of potential false positives, which may help identify strategies to make the system more reliable.

3.1.3 Downtime

Animal detection systems should preferably be operational at all times. However, certain systems only work during the night (e.g., several infrared systems). This may not be a problem if the species concerned is inactive or stays away from roads, traffic and other human related disturbance during the day. If animal crossings and collisions also occur during the daytime, it is important to select a system that is operational both day and night.

Animal detection systems usually rely on highly advanced and new technologies. Combined with the fact that most systems have not yet been thoroughly tested in a roadside environment, animal detection systems or certain components may malfunction relatively easily. It is important to check for potential problems regularly and to address these problems as soon as possible in order to minimize the downtime. Other systems may require a high degree of maintenance, which may also result in downtime. Finally, certain conditions (e.g., weather, vegetation) may make a system periodically dysfunctional. Downtime of animal detection systems may be substantial and is an important parameter of system reliability.

3.1.4 Normalize false positives and false negatives

In order to compare different systems with different monitoring methods employed, the reliability measurements should be normalized; however, many of these systems have adjustable sensitivities. Adjusting a system to be more sensitive would reduce the number of false negatives but increase the number of false positives. Therefore, WTI researchers recommend applying the methods often used to compare freeway incident detection algorithms (see *Cheu and Ritchie 1995*).

Consider the following definitions:

- Detection Rate (DR) = $100\% * (\text{Total Crossing} - \text{False Negatives}) / \text{Total Crossings}$
- False Alarm Rate (FAR) = $100\% * \text{False Positives} / \text{Total Number of Applications of Detector}$

Described below is a theoretical example of the calculations and comparisons for the Detection Rate (DR) and False Alarm Rate (FAR) for two systems. System A is monitored for four days (96 h). The system polls the detectors every 15 sec for a total of 23,040 applications of the detectors in the four-day period. During these four days 25 large animals crossed the road. Of these animals 16 are detected by the system, resulting in 9 false negatives. Additionally, there are 115 detections when no large animals were present (false positives). These values can be used to compute a DR of 64% and a FAR of 0.5%.

Some systems poll the detectors very frequently, for example once per second. If this is the case it may be more appropriate to determine the FAR based on the number of one-minute time intervals where one or more false positives occurred and divide by the total number of one-minute time intervals in the monitoring period.

For different sensitivity settings of the sensors the theoretical performance of System A is compared to that of another system known as System B. The theoretical DR and FAR are plotted in Figure 3.1. If only the middle point of each system were compared, System A would be better, with the same FAR, but a higher DR. However, should a much lower FAR be desired, System B would be preferred.

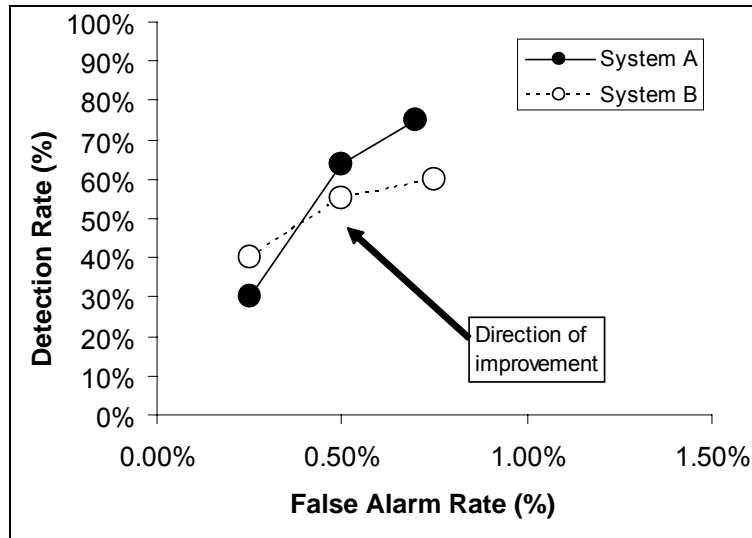

Figure 3.1: Comparing system reliability at multiple sensitivity settings for multiple systems

3.2 SYSTEM EFFECTIVENESS

System effectiveness, i.e., fewer and less severe animal-vehicle collisions, can be obtained through two mechanisms: increased driver alertness and reduced vehicle speed (see also Chapter 2).

3.2.1 Driver alertness

Activated warning signs are likely to make drivers more alert. Driver reaction time to an unusual and unexpected event can be reduced from 1.5 sec to 0.7 sec if drivers are warned (*Green 2000*). Assuming a constant vehicle speed of 88 km/h (55 mi/h) before and after the warning signals are presented to the driver, increased driver alertness could reduce the stopping distance of the vehicle by 21 m (68 ft). This reduction in reaction time and stopping distance, however, has not specifically been tested with respect to the presence of large animals in rural areas. Experiments with a driving simulator (see e.g., *Hammond and Wade 2004*) that simulates animal movements across the road and measures driver behavior (e.g., reaction time, breaking, stopping distance, and speed on impact) could fill this knowledge gap.

The awareness and alertness of the driver is likely to be influenced by the type of warning signals presented. Currently there are no specific standards for these warning signals and signs, and regulations and practices differ between countries and different regions within a country. There is evidence, however, that different signs are interpreted differently by drivers. If drivers are presented with a non-activated warning light and a standard black on yellow deer warning sign, accompanied by a black on yellow warning text sign saying “Use extra caution when flashing,” 92% of the respondents interpret the sign correctly, i.e., that there may still be deer on the road despite the fact that the warning signals are not activated (*Katz, et al. 2003*). This percentage is much lower with other text signs: “Animal detected when flashing” (57.6%); and

“When flashing” (62.5%). Drivers may not increase their eye movements (scanning behavior) in response to activated warning signs (*Hammond and Wade 2004*). The presence of deer or a deer decoy in the right-of-way does seem to trigger a relatively strong reduction in vehicle speed when the flashing warning lights are activated (*Gordon, et al. 2001; Gordon and Anderson 2002; Kinley, et al. 2003*). This indicates that activated warning signals may indeed cause drivers to be more alert.

Experiments with a driving simulator that displays various types of warning signals could lead to additional insight into how different types of warning signals and signs influence driver awareness, alertness, reaction time, and the driver’s ability to avoid a collision. Driving simulator studies may also help determine at what interval the warning signals and signs should be placed. If the warning signals and signs are far apart, the first driver to encounter a large animal on or near the road may not have passed an activated warning sign before the animal is encountered.

3.2.2 Vehicle speed

Once a driver is aware that a large animal may be on or near the road ahead, the driver may lower the speed of the vehicle. Previous studies have shown variable results: substantial decreases in vehicle speed (≥ 5 km/h (≥ 3.1 mi/h)) (*Kistler 1998; Muurinen and Ristola 1999; Kinley et al. 2003*); minor decreases in vehicle speed (< 5 km/h (< 3.1 mi/h)) (*Kistler 1998; Muurinen and Ristola 1999; Gordon and Anderson 2002; Kinley, et al. 2003; Gordon, et al. 2004; Hammond and Wade 2004*); and no decrease or even an increase in vehicle speed (*Muurinen and Ristola 1999; Hammond and Wade 2004*). This variability of the results is likely related to various conditions:

- the type of warning signal and signs (see also Chapter 4);
- whether the warning signs are accompanied with advisory or mandatory speed limit reductions;
- road and weather conditions;
- whether the driver is a local resident; and
- perhaps also cultural differences that may cause drivers to respond differently to warning signals in different regions.

Kistler (*1998*) found that drivers reduced their speeds substantially when presented with activated warning signals (see Chapter 4) that were accompanied with a mandatory reduction of the maximum speed limit (40 km/h, 24.8 mi/h). The average vehicle speed decreased from 68 km/h (42.3 mi/h) (warning lights off) to 46 km/h (28.6 mi/h) (warning lights on). Other locations that had warning signs only and no reduced maximum speed limit showed only a minor reduction in vehicle speed. Here the average vehicle decreased from 51 km/h (31.7 mi/h) (warning lights off) to 47 km/h (29.2) (warning lights on). However, vehicle speed with the lights off was relatively low already and vehicle speed with the lights on was similar to that with activated warning signals in combination with a mandatory reduction in speed limit.

During the day, Muurinen and Ristola (*1999*) observed a slight increase in vehicle speed as a response to the activated warning signals: an increase of 0.4-0.5 km/h (0.2-0.3 mi/h). During the night however, there was a minor reduction in vehicle speed: 1.6-2.6 km/h (1.0-1.6 mi/h); and drivers reduced their speeds substantially when it rained, 14.0-15.6 km/h (8.7-9.7 mi/h). These

results suggest that drivers are more likely to reduce vehicle speeds and reduce it substantially when visibility and road conditions are poor.

Drivers that live in the area surrounding an animal detection system are more likely to be familiar with the purpose and reliability of an animal detection system than non-locals. If the animal detection system is reliable and if drivers receive confirmation (i.e., observe an animal when warning lights are on and do not when warning lights are off), local drivers may learn to trust an animal detection system. Therefore, local drivers may be more alert, and they may reduce their speed more than non-local drivers. However, if an animal detection system is not reliable, or if the drivers do not receive confirmation, local drivers may be less responsive than non-local drivers.

Kistler (1998) found that local drivers showed greater speed reduction than non-locals, as shown in Table 3.1. These readings indicate that local drivers may have trusted the animal detection systems more than non-local drivers. This also suggests that driver response may be less pronounced on roads that have a relatively high proportion of non-local drivers. Finally, the results indicate that one is more likely to find a response (lower vehicle speed) to the flashing warning lights if drivers have been given the opportunity to learn to trust the system. Therefore speed readings taken immediately after system installation may show smaller speed reductions than speed readings taken three months later, for example.

Table 3.1: Speed reduction comparisons – local vs. non-local drivers

	Local Drivers		Non-Local Drivers	
	Warning Lights Off	Warning Lights On	Warning Lights Off	Warning Lights On
With mandatory speed limit reduction	68 km/h (42.3 mi/h)	44 km/h (27.3 mi/h)	70 km/h (43.5 mi/h)	51 km/h (31.7 mi/h)
Without mandatory speed limit reduction	51 km/h (31.7 mi/h)	44 km/h (27.3 mi/h)	50 km/h (31.1 mi/h)	47 km/h (29.2 mi/h)

Minor reductions in vehicle speeds may not seem meaningful, but the relationship between vehicle speed and the risk of fatal accidents (for humans) is exponential (Kloeden, et al. 1997). This means that at high vehicle speed a small decrease in speed results in a disproportionately large decrease in the risk of the severity of a potential accident. Thus a relatively small reduction in vehicle speed can be very important. However, the relationship between vehicle speed and the risk of fatal accidents has not specifically been tested with respect to large animals in rural areas.

Since small reductions in vehicle speed are important, speed studies must have relatively large sample sizes. For example, in order to detect a substantial reduction in vehicle speed (≥ 5 km/h; ≥ 3.1 mi/h), a minimum of 115 vehicles per treatment is required (1 sided t-test, $\alpha = 0.05$, power = 0.8) (Figure 3.2). This number is based on a power analysis conducted with speed data from the MT test site (see Chapter 5). To detect smaller reductions in vehicle speed a much larger sample size is required. For example, in order to detect a reduction in vehicle speed of ≥ 2.5 km/h (≥ 1.6 mi/h), a minimum of 455 vehicles per treatment would be required (1 sided t-test, $\alpha = 0.05$, power = 0.8) (Figure 3.2). Other sites may have different vehicle speeds and variation in speed. As a consequence other sites may require a higher or lower minimum sample size.

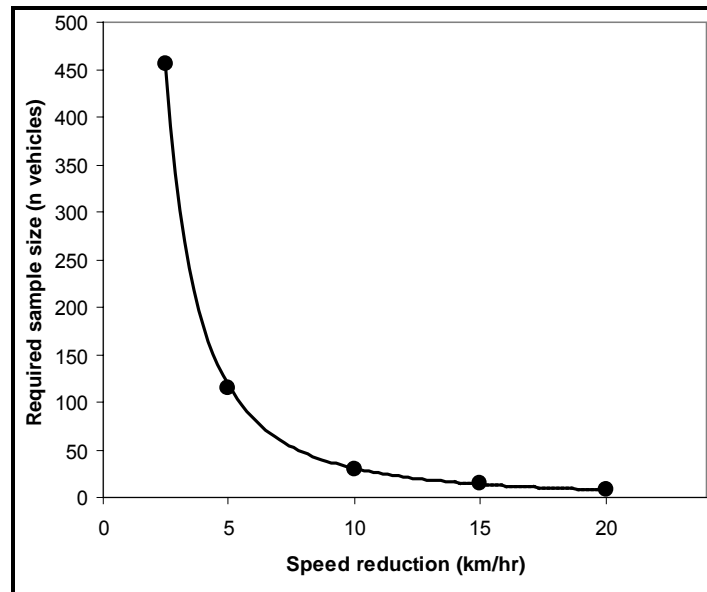

Figure 3.2: Sample size to detect speed reduction

Figure 3.2 shows the sample size (number of vehicles) required to detect a certain reduction in vehicle speed. (1 sided t-test, $\alpha=0.05$, power = 0.8). This power analysis is based on speed data from independently traveling passenger cars and combined trucks at the MT site (see Chapter 5): mean vehicle speed was 108.7 km/h, SD=15.2, n=52 (67.5 mi/h, SD=9.4) even though the posted speed limit is only 88 km/h (55 mi/h). There was no significant difference between the speed of passenger cars and combination trucks ($P=0.382$, 2-sided t-test); nor was there a significant difference in the speed between the two travel directions: passenger cars: $P=0.284$; or combination trucks: $P=0.944$ (2-sided t-test).

There may be many factors to consider when designing speed studies: 1) lights on or off; 2) vehicle type; 3) day or night; 4) road surface dry, wet or icy; and 5) no precipitation, fog, rain or snow. Sex and age of the driver are also related to vehicle speed, but one may not be able to record these variables without stopping the vehicle or recording individual license plates. The first five factors listed above may already result in a very high number of speed readings, especially if one is interested in detecting relatively small reductions in vehicle speed.

Depending on the road conditions and traffic volume, vehicles may travel in groups (platoons) as there may be few opportunities to overtake other vehicles. When measuring the effect of flashing warning lights on vehicle speed, it is important to only include the speed data from the first vehicle in a platoon, as the speeds of the following vehicles are likely to be influenced by that of the first vehicle.

Speed readings that time vehicles passing over a known distance can be obtained in various ways, including traffic counters, radar guns and stopwatches. Traffic counters allow for automated data collection which can be very convenient, especially if large sample sizes are

required. However, many traffic counters require tubes across the road, and this technique cannot be used in areas that receive snow, as snowplows destroy the tubes. Radar guns and related equipment may require parked cars, radar signals, trailers, and other objects to be near the road, which may trigger drivers to reduce their speed (*Robertson 2000*), regardless of whether the warning signs are activated. Timing vehicles from a distance with a stopwatch does not affect driver behavior and can result in data that are not confounded by other factors. However, it is imperative that the error rate in starting and stopping the stopwatch is negligible compared to the total traveling time (*Pignataro 1973*). In addition it is important to realize that these vehicle speeds relate to the average speed over the distance concerned; it is not a spot speed. This is neither good nor bad. Spot speed measurements are more likely to result in relatively high and low vehicle speed readings than speed measurements over a certain distance. However, when measuring vehicle speed in an animal crossing zone, speed measurements that relate to this zone rather than a spot in this zone may be more appropriate.

3.2.3 Animal-vehicle collisions

Transportation agencies, highway patrol, or other organizations or individuals usually record animal-vehicle collisions or road kill before and after an animal detection system is installed. It is important that the data are collected for several years both before and after installation (comparison in time) as well as at the site with the animal detection system and on road sections in the surrounding area (comparison in space). Comparisons in time may be confounded by fluctuating animal populations, changes in traffic volume and the time of travel, and changes in the landscape that may influence animal movement patterns to and from the road. Comparisons in space may be influenced by variability in site conditions, as well as other factors that may change or differ between the test and control sites.

A major challenge is that the road sections over which animal detection systems are installed are often relatively short, usually only a couple of hundred meters (yards) (see Chapter 4). The average number of large animals that was killed per time period prior to the installation of an animal detection system on those short road sections is usually relatively low, perhaps no more than one or two per year. In addition, the number of collisions can vary substantially from year to year at a specific location due to chance alone. Combined with the fact that most projects only collect data from one location for a few years, it is potentially hard to show a statistically significant reduction in the number of animal-vehicle collisions after a system is installed and activated. Long road sections with animal detection systems at multiple locations and monitoring over many years can help overcome these issues. An alternative is to combine the road kill and animal-vehicle collision data for different systems from different locations. Such a meta-analysis would show whether animal detection systems, regardless of the system type and manufacturer, reduce the number of animal-vehicle collisions.

Animal-vehicle collision or road kill data must be based on a fixed search and reporting effort (monitoring) if the data are used to evaluate the effectiveness of an animal detection system. Monitoring data does not necessarily require that every collision or carcass be reported, but it does require a fixed search and reporting effort. Incidental observations or an inconsistent search and reporting effort result in data that are not suitable to investigate the most important measures of system effectiveness: the number of animal-vehicle collisions or the number of road kill.

Even if monitoring data are collected, the data may not be properly documented, published or available for analyses. Only Kistler (1998), Romer and Mosler-Berger (2003), and Mosler-Berger and Romer (2003) have published on the number of animal-vehicle collisions before and after seven infrared area cover detection systems were installed in Switzerland (Table 3.2; see also Chapter 4). These systems reduced the number of animal-vehicle collisions by 82% on average (1-sided Wilcoxon matched-pairs signed-ranks test, $P=0.008$, $n=7$). See Kistler (1998) and Section 4.4.1 for details on the seven sites and systems. All seven sites showed a reduction in collisions after an animal detection system was installed, and three of the seven sites did not have a single collision after system installation (as of 6-7 years after installation). The data relate to collisions with roe deer (*Capreolus capreolus*) and red deer (*Cervus elaphus*), and collisions that occurred during the day when the systems were not active were excluded from the analyses.

Table 3.2: Collisions with large animals before and after detection system installation in Switzerland

Location	Before			After			Reduction	
	Coll. (N)	Yrs	Coll./yr	Coll. (N)	Yrs	Coll./yr	Coll./yr	%
Warth	14	7	2.00	3	10	0.30	1.70	85.00
Soolsteg	8	11	0.73	1	6	0.17	0.56	77.08
Val Maliens	7	3	2.33	6	5	1.20	1.13	48.57
Marcau	12	4	3.00	6	5	1.20	1.80	60.00
Schafrein	26	8	3.25	0	6	0.00	3.25	100.00
Duftbächli	18	8	2.25	0	6	0.00	2.25	100.00
Grünenwald	6	8	0.75	0	7	0.00	0.75	100.00
Average reduction								81.52

While the sites with animal detection systems showed a marked reduction in the number of animal-vehicle collisions, the total number of animal-vehicle collisions in the wider region remained constant (Kistler 1998). This is further evidence that the reduction in collisions is indeed related to the presence of the animal detection systems and not the result of potential reductions in the ungulate populations or major changes in traffic volume and time of travel. Furthermore, detection data stored by the systems and tracking data confirmed that ungulates still frequented the sites (Mosler-Berger and Romer 2003).

4.0 OVERVIEW OF ANIMAL DETECTION SYSTEMS THROUGHOUT NORTH AMERICA AND EUROPE

Authors: Marcel P. Huijser and Patrick T. McGowen
Western Transportation Institute, Montana State University
P.O. Box 174250, Bozeman, MT 59717-4250 (e-mail: mhuijser@coe.montana.edu)

4.1 INTRODUCTION

This chapter identifies all animal detection systems and their study sites throughout North America and Europe known to the authors as of February 2006. The chapter describes the main characteristics of the systems and reviews the experiences with installation, operation and maintenance. This chapter is a partial update from Huijser and McGowen (2003).

4.2 METHODS

This review of animal detection systems is based on previous overviews (*Farrell, et al. 2002; Robinson, et al. 2002; Huijser and McGowen 2003*), research reports, internet sources, newspaper articles, press releases, and interviews with researchers, system manufacturers (see Appendix E), system integrators, and employees from transportation agencies. The overview distinguishes between locations that have operational systems, installed systems that are no longer or not yet operational, dismantled systems, and planned systems (as of February 2006).

The systems are classified into two main categories; area-cover systems and break-the-beam systems (see Chapter 2). Additionally, two unique systems are identified. Each system is described with respect to the following parameters:

- Location;
- Target species;
- Technology;
- System vendor;
- System installer;
- Road length covered by the sensors;
- Presence or absence of adjacent fencing;
- System costs;
- Installation costs;
- Availability of data on the experiences with installation, operation and maintenance, and system effectiveness (vehicle speed, number of animal-vehicle collisions);
- Month and year of installation; and
- Period of operation.

Finally, additional issues that may affect the operation and maintenance of animal detection systems are discussed.

4.3 SYSTEM NUMBERS AND GENERAL LOCATION

Thirty-four (34) locations with an animal detection system have been identified. Twelve (12) of these sites are located in North America (Figure 4.1). To the best of the author's knowledge only 5 of these sites have a system that is currently in operation. The driver warning signs at one of these 5 sites (Yellowstone National Park, MT) are not currently operational. One (1) other site has a system installed, but the system has been temporarily deactivated and is thus classified as "non-operational" (Marshall, MN). At the remaining six sites the systems have been dismantled.



Figure 4.1: Location of animal detection systems in North America

In Europe 22 locations with animal detection systems have been identified (Figure 4.2). It is known that 15 of them have systems that are currently in operation. The systems on the remaining seven sites have been dismantled.

In addition to the 34 sites mentioned above, seven sites in North America and 20 sites in Europe have been identified where an animal detection system is in the planning phase (as of February 2006).

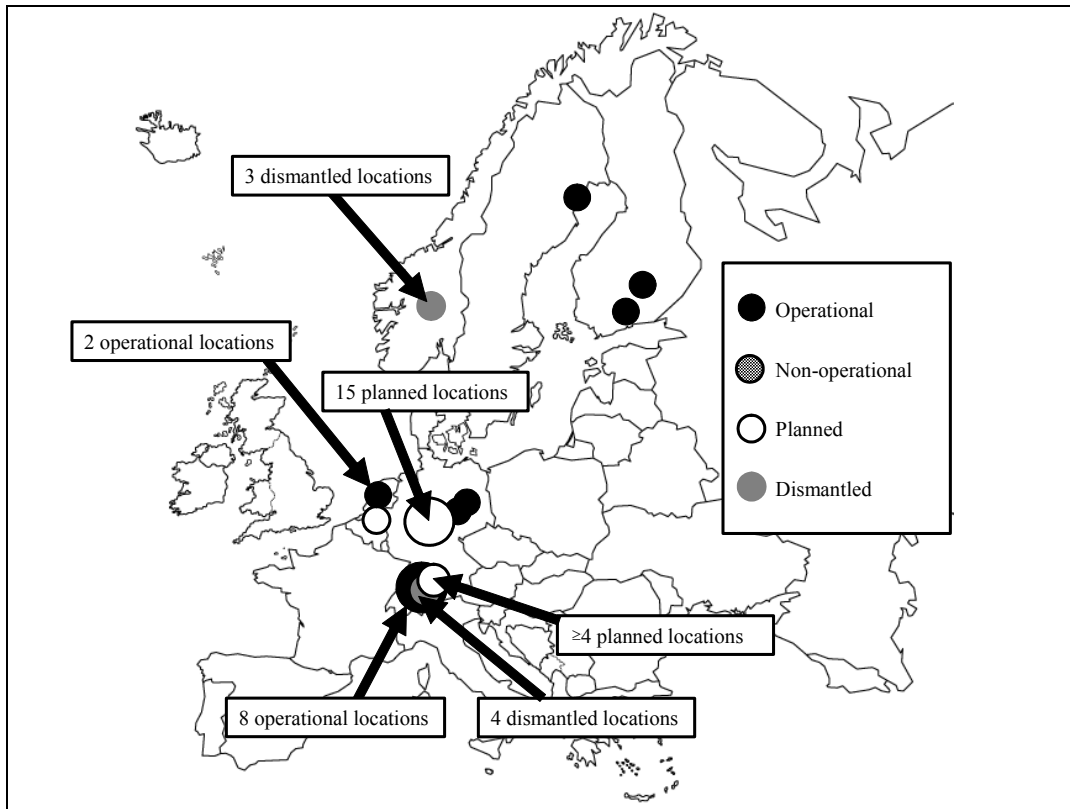

Figure 4.2: Location of animal detection systems in Europe

4.4 EXISTING OR DISMANTLED SYSTEMS

The main characteristics of existing or dismantled systems are listed in Table 4.1. More details on the area-cover systems are described in Sections 4.4.1. through 4.4.3, 4.4.8, 4.4.11, 4.4.16, and 4.4.19. Break-the-beam-systems are described in Sections 4.4.4 through 4.4.7, 4.4.10, 4.4.12 through 4.4.15, 4.4.17, and 4.4.19. Two unique systems are described in Sections 4.4.8, 4.4.9, and 4.4.18.

4.4.1 Seven locations in Switzerland

Kistler (1998), Tschudin (1998), Romer and Mosler-Berger (2003) and Mosler-Berger and Romer (2003) reported on a study that covered seven locations in Switzerland. The systems were supplied by Calonder Energy AG in Chur, Switzerland (CALSTROM animal detection systems). Each system consisted of a series of passive infrared sensors. The sites, their installation dates, road length covered and number of sensors installed, are listed in Table 4.2. The passive sensors were designed to detect ungulates such as roe deer (*Capreolus capreolus*) and red deer (*Cervus elaphus*) within a 30-100 m (32.7-109 yd) radius.

Table 4.1: Characteristics of animal detection systems

ID #	Location	Target species	Distance covered	Fence	Cost of System	Cost to Install	Eval.	Date(s) Installed	Date(s) Operational
1	7 locations CH	Roe/red deer	50-200 m	No	\$11,500	UNKN	OVC	1993-'96	1993/'96 - present ¹
2	Box, Uusimaa, FIN	Moose	220 m	Yes	\$60,000	\$40,000	OV	Sep 1996	Dec 1996 - present
3	Mikkeli, FIN	Moose	90 m	Yes	\$40,000	\$30,000	O	1999	1999 - present
4	5 locations CH; 2 loc. D	Roe/red deer	UNKN	UNKN	±\$20,000 ³		UNKN	1998-'01/'02?	CH: in operation
5	2 locations NL	Roe/red deer, wild boar	200-250 m	Yes	±\$50,000 ⁴		O	1999	2 in operation
6	Rosvik, S	Moose	100 m	Yes	±30,000	UNKN	O	1999	2000 - present
7	Colville, WA, USA	Deer, elk	402 m	No	\$ 9,000 ⁶	\$3,000	O	20 Jun 2000	Removed spring 2002
8	Nugget Canyon, WY, USA	Mule deer	92 m	Yes	\$200,000 ²	UNKN	OV	1 Dec 2000	8 Dec 2000 - 21 May 2001
9	Sequim, WA, USA	Elk	4,827 m	No	\$60,000 ¹¹ \$13,000 ¹²	UNKN	OC	Apr 2000	Apr 2000 - present
10	Marshall, MN, USA	White-tailed deer	1,609 m	No	\$50,000	\$7,000 ⁷	O	Jun 2001	Turned off Nov 2001
11	Kootenay NP, BC, CAN	White-tailed deer	1,000 m	No	UNKN	UNKN	OV	Jun 2002	Sep 2003 - Oct 2003
12	IN Toll Road, IN, USA	White-tailed deer	9,654 m ¹⁰	No	\$1,300,000	UNKN	O	Apr 2002	Oct 2004 - present
13	Wenatchee, WA, USA	Deer	213 m	No	<\$40,000 ⁸	UNKN	OC	Oct 2002	Removed spring 2004
14	Yellowstone NP, MT, USA	Elk	1,609 m	No	\$349,000 ⁹	\$60,000	O	Oct/Nov 2002	Nov 2004 - present
15	Los Alamos, NM, USA	Elk	30 m	No	\$500 ¹⁴	\$2,000	O	Nov 2002	Nov 2002 - Feb 2003
16	Thompson-town, PA, USA	White-tailed deer	±804 m	No	\$90,000	\$130,000	O	May 2004	Removed 31 Jan 2005
17	Herbertville, Quebec, CAN	Moose	10 m	Yes	\$4,100	\$4,100	OC	Fall 2004	Spring 2005 - present
18	Pinedale, WY, USA	Mule deer, pronghorn	2,180 m	No	\$982,510 ¹⁵	\$982,510 ¹⁵	OVC	Oct 2005	Oct 2005 - present
19	[UNKN], NOR	UNKN	UNKN	UNKN	UNKN	UNKN	UNKN	UNKN	UNKN

Location: CH = Switzerland, D = Germany, FIN = Finland, NL = The Netherlands, NOR = Norway, S = Sweden

Target species: W-t deer = White-tailed deer; M-deer = Mule deer; Boar = wild boar

Distance covered: See page ii for conversion from metric units

Evaluation: Information available on: O = Operation and maintenance; V = Vehicle speed; C = Animal-vehicle collisions

Date(s) operational: Present = December 2005

UNKN = unknown; specific information not available

¹ Three operational, rest dismantled

² Including operation and maintenance, research, excl. WYDOT salaries
³ In CH

⁴ Including installation and fence

⁵ Excluding ± \$70,000 for electricity

⁶ Excluding signage, batteries

⁷ Excluding salaries

⁸ Including research, design, installation

⁹ Including research and development

¹⁰ Divided over 6 sections

¹¹ Equipment

¹² Herding and collaring

¹³ Excluding in kind contributions

¹⁴ Excluding salaries and video equip

¹⁵ Equipment and installation combined

Table 4.2 shows the main characteristics of the seven systems located in Switzerland (*Kistler 1998*; Mosler-Berger, Swiss Wildlife Information Service, personal communication). See page ii for conversion from meters (m) to yards (yd) or mile (mi).

Table 4.2: Characteristics of area cover systems in Switzerland

Location	Installed	Operational status	Road length covered (m)	Sensors (n)
Warth	February 1993	Operational (Oct 2003)	150	7
Soolsteg	November 1996	Operational (Oct 2003)	80-90	6
Val Maliens	May 1993	Dismantled after 1997	150	5-8
Marcau	May 1993	Dismantled Aug 1997 (road work)	50-60	2
Schafrein	December 1995	Dismantled mid 2002 (road work)	80	5-6
Duftbächli	December 1995	Dismantled mid 2002 (road work)	30-50	4
Grünenwald	December 1995	Operational (Oct 2003)	190-200	4-6

The sensors were installed in a 20-30 m (21.8-32.7 yd) wide zone on both sides of the road. Once an animal was detected LED signs with a deer symbol were activated to alert the drivers. Once activated, the signs stayed on for 45 sec. Five of the sites also had an LED sign with an enforceable maximum speed limit (40 km/h, 24.8 mi/h) (Figure 4.3); one of the sites (Warth) had an enforceable speed limit of 30 km/h (18.6 mi/h) until November 1996 (*Anonymous 1994a*; *Anonymous 1994b*, *Anonymous 1996*; *Kistler 1998*). The seven systems were only activated during the night. A time clock and light sensor switched the systems on and off automatically. The rationale was that human activities during the daytime would cause a high number of false detections. In addition, the sensors were relatively sensitive to differences in temperature, which occurs frequently during the day.

There were no fences or other barriers specifically erected for wildlife on either side of the crossing areas. However, most locations had support walls, steel nets and guardrails just before and after the crossing areas, which helped funnel the wildlife through the crossing area (*Kistler 1998*). Depending on the site, local game wardens or road maintenance personnel checked the system every 3-5 days, once a week, or once every two weeks. False detections were caused by passing vehicles with warm engines and by falling branches, especially in strong winds. Broken sensors, loss of power due to snow-covered solar panels, and broken lamps in the warning signs caused additional problems.



Figure 4.3: Warning signs with 40 km/h (25 mi/h) speed limit at a location in Switzerland (Photo: Mary Gray/FHWA).

4.4.2 Box, Finland

This system consists of microwave radar sensors that were designed to detect moose (*Alces alces*) in a 220 m (239.8 yd) wide gap in a several kilometers long moose proof fence along Hwy 7, near Box, between Helsinki and Porvoo. It is located about 20 km (12.4 mi) southwest of Porvoo, Uusimaa, Finland (Taskula 1997; Muurinen and Ristola 1999; Kari Taskula, Sabik, personal communication). Sabik Ltd, Finland, supplied and installed the system. Five poles are placed on each side of the road 5-20 m (5.5-21.8 yd) from the pavement. Each pole has two sensors that faced away from the road. The sensors are designed to detect large animal movements up to 50 m (54.5 yd) distance within a 60° horizontal angle.

When a large animal is detected, LED message signs with a moose symbol are turned on. The signs warn drivers about the presence of large animals on or near the road, remaining lit for two to three minutes after being triggered by an animal. The message signs are located 150-200 m (163.5-218 yd) before the crossing area. Detection of a large animal also activates a video camera and recorder. The camera turns and zooms toward the detection area. The images are used to verify the presence of large animals and to evaluate the reliability of the system. The system records start and end time of every detection event of all detectors, the status of the signs (on or off), and invalid detections. The data are stored in a file that is downloaded on a daily basis from a remote location through a modem and a user interface program. It is also possible to open the modem connection through the user interface program and to monitor the system real time.

The system was installed in September 1996 with tests and modifications to the system taking another three months. To distinguish moose from other moving objects such as rain or spray from passing vehicles on the road, the system was programmed to only detect objects moving towards the sensors at a speed greater than 0.8 m/s (0.87 yd/s). The sensors were placed 3 m (3.27 yd) above the ground and their vertical angle was modified to reduce false detections caused by small animals such as rabbits and birds. Furthermore the signal had to be contiguous for at least 0.5 sec.

Rain and variations in air pressure also caused false detections. This was mitigated by attaching metal eaves to the detectors and by filtering out rain noise at the interface. In addition, 16 passive infrared detectors and one rain detector were integrated into the system to help filter out false detections (*Taskula 1999*). The microwave detectors were automatically switched off if multiple consecutive detections were reported after rain was detected. The system operated on infrared detectors only under those conditions. After the system became fully operational in mid-December 1996, some false detections continued to occur (*Taskula 1999*; Kari Taskula, Sabik, personal communication). In spring when the snow melted and the water warmed on the pavement, spray from passing vehicles triggered the system. After improvements were made in 1997-1998, most of the problems disappeared, and false detections became rare. There are still a few false detections in spring, however.

4.4.3 Mikkeli, Finland

This system is similar to the one described above. It is located along Hwy 5, between Lahti and Mikkeli, about 25 km (15.5 mi) south-west from Mikkeli, Finland (Kari Taskula, Sabik, personal communication). The detector poles are located 5 m (5.5 yd) from the pavement. If an agreement had been reached with a local landowner, the detectors would have been placed 15-20 m (16.4-21.8 yd) from the roadside. This would have eliminated false detections caused by spray from passing vehicles. Gaps in the fence at side roads and the relatively short width of the crossing area increase the chance that moose wander off along the road in the right-of-way, instead of crossing the road at a straight angle. However, only one such event has ever been documented (as of September 2003).

4.4.4 Five sites in Switzerland; two sites in Germany

In addition to the 7 sites described in Section 3.4.1, five other animal detection systems have been installed in Switzerland after Kistler's study was published. The locations are near St. Annawald (1998), In den Böschen (1999), Grauholz (1999), Herenacher (2001) and Chaltibach (2003) (*Kistler 2002*; *Romer and Mosler-Berger 2003*; *Mosler-Berger and Romer 2003*; Jann Romer, Infodienst Wildbiologie and Oekologie, Swiss Wildlife Information Service, personal communication). The systems came from the same manufacturer (Calonder Energy AG), but the technology seemed to differ from the seven sites described under Section 3.4.1; these newer systems work on a break-the-beam principle (*Kistler 2002*). Some systems operate on laser beams, while others operate on infrared beams.

The five systems were operational in October 2003. An additional two sites have been installed in Germany between Kassel and Herleshausen in Hessen (Bundesstrasse B400, Alberberg,

Eschweg) and Sachsen-Anhalt (*Anonymous 2002b*; Christa Mosler and Jann Romer, Infodienst Wildbiologie and Oekologie, Swiss Wildlife Information Service, personal communication).

4.4.5 Two sites in the Netherlands

There were two systems installed in The Netherlands: one near 't Harde (N309) (Figures 4.4-4.8) and one near Ugchelen (N304) (Figures 4.9 and 4.10) (Herman van Zandbrink, Provincie Gelderland, personal communication; *van den Hoorn 2000*). The system manufacturer was Calonder Energy AG, the same as discussed in Sections 4.4.1 and 4.4.4. The two systems in the Netherlands are designed to detect wild boar (*Sus scrofa*), roe deer and red deer. They are solar powered (Figure 4.7) and operate on a focused infrared beam that is positioned at ± 50 cm (± 19.5 in) above the ground (Figure 4.6 and Figure 4.10). The crossing areas are about 200-250 m (218-272.5 yd) wide and have about 500 m (545 yd) long fences before and after the crossing area on both sides of the road (Figure 4.6). Once an animal is detected LED warning signs with a red deer in combination with an advisory 50 km/h (31.1 mi/h) speed limit sign are activated (Figure 4.4, Figure 4.5, and Figure 4.9). The systems are only switched on during the night. The animals tend to stay away from the road during the daylight hours (Herman van Zandbrink, Provincie Gelderland, personal communication).



Figure 4.4: Warning signals and sign in 't Harde, The Netherlands (Photo: Marcel Huijser/WTI/MSU)



Figure 4.5: Activated warning signal and sign in 't Harde, The Netherlands (Photo: Marcel Huijser/WTI-MSU)



Figure 4.6: Cabinet with infrared sensor in 't Harde, The Netherlands (Photo: Marcel Huijser/WTI-MSU)



Figure 4.7: Solar panel and control cabinet in 't Harde, The Netherlands (Photo: Marcel Huijser/WTI-MSU)



Figure 4.8: Control cabinet in 't Harde, The Netherlands (Photo: Marcel Huijser/WTI-MSU)



Figure 4.9: Warning signal and sign in Ughelen, The Netherlands (Photo: Marcel Huijser/WTI-MSU)



Figure 4.10: Cabinet with infrared sensor in Ugchelen, The Netherlands. The wire in front of the two openings prevents birds from nesting in the box. (Photo: Marcel Huijser/WTI-MSU).

The sensor boxes (Figure 4.6 and Figure 4.10) have to be well anchored on a concrete foundation to remain stable (Herman van Zandbrink, Provincie Gelderland, personal communication). Ventilation of the boxes is also an issue, as rain or snow may cause the lens to fog up. The distance between the sensors (200-250 m, 218-272.5 yd) may be a little too far; smaller distances may reduce the number of false detections. Fallen trees and tall grasses can also produce false detections, as the sensors were only ± 50 cm (± 19.5 in) above the ground. From time to time the batteries lose too much power. Lightning has struck one of the sensors, which caused a series of false detections. In addition, vehicles that have run off the road damaged equipment on two occasions: a sensor post and a signal pole. Another problem has been when small birds have used the sensor box as a nesting site (Marcel Huijser, personal observation). Mesh wire in front of the holes has solved this problem (Figure 4.10). One system appears to work well (near 't Harde), while the other system (near Ugchelen) has technological problems (Herman van Zandbrink, Provincie Gelderland, personal communication).

4.4.6 Rosvik, Sweden

In 1999 an animal detection system was installed along highway E4 near Rosvik in northern Sweden, between Piteå and Luleå (Figures 4.11-4.13) (Andreas Seiler, Grimsö Wildlife Research Station, Department of Conservation Biology, Swedish University of Agricultural Sciences, personal communication; Kjell Ståhl, Road Administration, Luleå, personal communication). The system was designed by PIK AB, Karlskrona, Sweden, and installed by the manufacturer and the Road Administration. The system operates on a break-the-beam principle with infrared light.



Figure 4.11: Warning signs in Rosvik, Sweden (Photo: Andreas Seiler)



Figure 4.12: The posts holding the lights in Rosvik, Sweden (Photo: Andreas Seiler).



Figure 4.13: The crossing area in Rosvik, Sweden. Note the two lanes one direction and one lane in the other direction separated by a wire fence (Photo: Kjell Ståhl/Road Administration, Luleå)

The system was installed in a 100 m (109 yd) wide opening in a fence and was designed to detect moose (Andreas Seiler, Grimsö Wildlife Research Station, Department of Conservation Biology, Swedish University of Agricultural Sciences, personal communication). The infra-red sensors were placed 20 m from the road and covered the entire gap in the fence, with two sensors on each side of the road. When an animal is detected low intensity halogen lights are turned on that illuminate the highway and right-of-way at the crossing area (Figure 4.12). This should allow drivers to see the animal better. The lights are turned off automatically 10 minutes after the last detection.

A standard moose crossing sign with the text “wildlife passage” is located just before the crossing area (Figure 4.11). The standard speed limit is 90 km/h (55.9 mi/h) in summer and 70 km/h (43.5 mi/h) in winter. Electricity supply was a major problem, which was resolved in winter 2001/2002. The road was later upgraded and now has two lanes in one direction, and one in the other direction, separated by a wire fence (installed in 2003). Animals using the crossing zone now have to jump over the wire fence in the middle of the road (Figure 4.13).

4.4.7 Colville, Washington, USA

On 20 June 2000 an animal detection system was installed on Hwy 395 (mile post 290), north of Spokane, south of Colville, three miles north of Chewelah, Washington (Shiple 2001; Robinson, *et al.* 2002; J. Schafer, WSDOT Research Office, personal communication; Brian Walsh, WSDOT, Traffic Safety and Operations, personal communication). The system consisted of two lasers, one placed on each side of the road, two standard deer warning signs, two smaller rectangular signs that read “When Flashing”, and two solar powered red flashing beacons (Figure 4.14). The system was designed by an electrical engineer (subcontracted) and manufactured in-house at the WSDOT Research Office. The system was installed by the vendor and WSDOT. When the laser beam was broken the lights were switched on. The lasers operated on batteries with a one-week lifespan while the red strobes were solar powered.



Figure 4.14: Warning signal and sign in Colville, Washington, USA (Photo: Washington Department of Transportation, Eastern Region)

Obtaining a clear line-of-sight in the right-of-way was a problem. In addition, the sighting of the lasers proved difficult, partly because of the distance between the sensors. Sunlight heating of the plastic boxes holding the laser equipment may have caused problems with the sighting of the laser (Shiple 2001; Robinson, et al. 2002; Brian Walsh, WSDOT, Traffic Safety and Operations, personal communication). False detections caused the batteries to drain quicker than anticipated. Finally the system experienced theft of solar-power units. The system was taken down in spring 2002.

4.4.8 Nugget Canyon, Wyoming, USA

The Flashing Light Animal Sensing Host (FLASH), designed to detect mule deer (*Odocoileus hemionus*), consisted of a series of infrared sensors placed at 17-19 m (18.5-20.7 yd) intervals on both sides of Hwy 30, at mile post 30.5, Nugget Canyon, between Kemmerer and Cokeville, Wyoming (Figures 4.15-4.22) (Gordon, et al. 2001; Gordon and Anderson 2002; Gordon, et al. 2004; Stanley Anderson, Wyoming Cooperative Fish and Wildlife Research Unit, personal communication). The FLASH system was designed by Victoria Gooch, and the Mid-American Manufacturing Technology Center (MAMTC) and the Wyoming Department of Transportation (WYDOT) installed the system (John Eddins, WYDOT, personal communication). There were five sensors on each side of the road (Figure 4.16), which spanned a 92 m (100.3 yd) gap in an 11,263 m (12,276.7 yd) long fence. The sensors were designed to detect the body heat of large animals. Once they did, flashing warning lights above a permanently visible warning sign were activated to alert drivers (Figure 4.15). The signs were placed about 300 m (327 yd) before the crossing area. The text read “ATTENTION, DEER ON ROAD WHEN FLASHING.”

In addition, a unique geophone unit (Eagle Telonics, Mesa, AZ), paired with infrared scopes, was installed on the south side of the road (Figure 4.17, Figure 4.18). An additional pair of infrared scopes was installed on the north side of the road in the second year (but no geophone unit), and microwave sensors (Figure 4.19) were installed south of the road. Finally a video-

camera system was installed to monitor deer moving through the crossing area (Figure 4.21 and Figure 4.22). The geophone unit was designed to detect ground vibrations caused by ungulates walking through the crossing area and also served as a control for the FLASH system. The infrared scopes on the south side of the road were part of the geophone system and had to be triggered at the same time as the geophone sensors to result in a valid detection. This was needed to eliminate false detections due to vibrations from passing trains on a nearby railroad and heavy vehicles (*Gordon, et al. 2001*; Bill Gribble, WYDOT, personal communication).



Figure 4.15: Activated warning signals and sign at Nugget Canyon, Wyoming, USA (Photo: Bill Gribble/WYDOT)



Figure 4.16: Infrared sensors attached to the white posts in the FLASH system at Nugget Canyon, Wyoming, USA (Photo: Bill Gribble/WYDOT)



Figure 4.17: Re-installation of the geophone system at Nugget Canyon, Wyoming, USA. The sensors were approximately 10 m (33 ft) apart at a depth of about 10 cm (4 in) below ground level to the top of the sensor. (Photo: Bill Gribble/WYDOT)



Figure 4.18: Infrared scope for the geophone system at Nugget Canyon, Wyoming, USA (Photo: Bill Gribble/WYDOT)



Figure 4.19: Microwave radar transmitters at Nugget Canyon, Wyoming, USA (Photo: Bill Moore, WYDOT)



Figure 4.20: Control cabinet at Nugget Canyon, Wyoming, USA. The large boxes are the counters for the animal detections and traffic. The upper shelf holds equipment for downloading data. This equipment used AC power. (Photo: Matt Johnson, WYDOT)



Figure 4.21: Video recorder system at Nugget Canyon, Wyoming, USA (Photo: Bill Gribble, WYDOT)



Figure 4.22: Two low-light cameras at Nugget Canyon, Wyoming, USA (Photo: Bill Gribble, WYDOT)

The microwave sensors formed a separate system, but they did not cover the entire area. This system was susceptible to false detections as a result of passing trucks, vegetation moving in the wind and birds. Repositioning of the radar heads resulted in complete area coverage, but false detections continued and the system was seldom used. The three detection systems were linked to one of three traffic counters to allow for remote access to the data (Bill Gribble, WYDOT, personal communication).

The systems were tested and modified during the 1998-1999 season. The passive infrared sensors of the FLASH system continued to suffer from reduced sensitivity due to sun exposure throughout the 1999-2000 season and were replaced by other infrared sensors in November 2000. The FLASH system became operational on 4 December 2000 (Gordon and Anderson 2002). The FLASH system worked reliably until January 2001, after which many false detections started to occur; more than 50% of the detections were false (Gordon, et al. 2001; Gordon and Anderson 2002). This was due to frost on the sensors, birds feeding on carrion in the crossing area, and snow thrown by passing snowplows. Additional problems occurred in early

April 2001, as a defective transmitter started to cause false detections in response to passing trucks.

No evidence was found that the FLASH system failed to detect deer moving through the crossing area. Nevertheless, the FLASH system was found to be too unreliable for deployment. The geophone system was never found to record false detections and seemed to be reliable, but a lightning strike did cause a problem (*Gordon, et al. 2001; Gordon and Anderson 2002*; Bill Gribble and Matthew Johnson, WYDOT, personal communication). It was suggested that the geophone system could be further developed in the future (see Section 4.4.18). A parallel effort, however, resulted in the construction of an underpass and the removal of the animal detection systems. Part of the equipment was used to monitor animal movements through the underpass (Bill Gribble, WYDOT, personal communication).

4.4.9 Sequim, Washington, USA

This system was installed along a $\pm 4,827$ m (± 3 mi) long section of Hwy 101, near Sequim, on the Olympic Peninsula, Washington (Figures 4.23-4.25). In 1999 about 10% of the elk herd was radio collared (*Williams 1999; New York Times 2001; Carey 2002*; Shelly Ament, Washington Department of Fish and Wildlife, personal communication). An effort was made to radio collar lead cows, but this was not always possible.

Receivers placed along the road scan for the frequencies of the individual radio collars 24 h per day. When the radio-collared individuals come within about 400 m (0.25 mi) of the road, the receivers that pick up the signal activate the flashing beacons that are linked to that receiver (Figure 4.23). Due to the directional antennas, however, the detection distance from the road varies for each location (David Rubin, Sequim Elk Habitat Committee, personal communication).

There are four receivers in total. Typically only one receiver picks up the signal at one time, but if the radio-collared individual is about halfway between two receivers, the signal may be picked up by both receivers. Two receivers are linked to only one flashing beacon (at both ends of the road section). The two other receivers are each linked to two flashing beacons, one for each travel direction. Standard black on yellow elk crossing signs that say “ELK X-ING” accompany the flashing beacons.

The system was designed and integrated by Shelly Ament and David Ruben, mostly with off-the-shelf equipment. WSDOT and the Washington Department of Fish and Wildlife installed the system. To block false detections, a device that counted the pulses of the radio signal had to be added (Figure 4.25). This device filtered out signals from other, non-elk radio transmitters. The system became operational in the fall of 2000. The batteries of the radios have a three-year life expectancy, but most of them last much longer.



Figure 4.23: Activated warning signal and sign in Sequim, Washington, USA (Photo: Marcel Huijser, WTI-MSU)



Figure 4.24: Shelly Ament manually scans the frequencies of the radio collared elk in Sequim, Washington, USA (Photo: Marcel Huijser, WTI-MSU)



Figure 4.25: Cabinet with electronics for automated scanning for frequencies of radio collared elk and battery at one of the receiver stations in Sequim, Washington, USA (Photo: Marcel Huijser, WTI-MSU)

A second capture session took place in March 2003. There were 8 elk (7 cows, 1 bull) fitted with radio collars in September 2003. The pre-hunting population estimate was 100-125 individuals in the fall of 2003. The system seems to work well, even after a change in habitat use caused the elk to cross the road more frequently than they used to. The farms around Sequim are a strong attraction to the elk. Maintenance has been limited to replacing the battery pack of a receiver and some minor repairs to a receiver. Some signs have been vandalized (paint), but they were cleaned relatively easily.

4.4.10 Marshall, Minnesota, USA

Around June 2001 an animal detection system was installed along a 1,609 m (1 mi) long section of Hwy 23 at Camden State Park southwest of Marshall, Minnesota (Figures 4.26 and 4.27) (*MNDOT 2001a*). This road section has a state park on one side of the road, and farmland that provides food for white-tailed deer on the other side of the road (Robert Weinholzer, Minnesota Department of Transportation, personal communication). More than 50 white-tailed deer are killed annually here (*The Post Bulletin 2005*).

The system consisted of a series of laser transmitters and receivers (Figure 4.27). It was integrated by Lewis Enterprises Inc., Saint Louis Park, MN. The vendor and MNDOT installed the system. The distance between the stations was approximately 200 m (218 yd) (Erik Lewis, Lewis Enterprises Inc., personal communication). The system had two laser beams between all stations. The lowest beam was about 65 cm (25.6 in) from the ground, and the second beam was about 30 cm (11.8 in) above the first (Robert Weinholzer, Minnesota Department of Transportation, personal communication; *MNDOT 2001b*). The system was only triggered when

both beams were broken at the same time. This reduced false detections as a result of e.g., flying birds, but not as a result of heavy fog. When both laser beams in the same segment were broken amber flashing beacons were activated that continued to flash for about one minute. The warning lights were situated on standard deer warning signs (Figure 4.26). In addition, there were advisory signs that notified drivers that they were entering a test area and that deer or other animals may be present when lights are flashing.



Figure 4.26: Warning signals and signs in Marshall, Minnesota, USA (Photo: Robert Weinholzer, MNDOT)



Figure 4.27: The sensors in the right-of-way in Marshall, Minnesota, USA (Photo: Robert Weinholzer, MNDOT)

Testing was suspended during the winter months due to high maintenance costs (*MNDOT 2001b*). The batteries had to be replaced more often than anticipated and the grass-herb vegetation between the sensors had to be mowed regularly, as the tall grass caused many false detections (Robert Weinholzer, Minnesota Department of Transportation, personal communication; *MNDOT 2001b*).

The Minnesota Department of Transportation plans to provide solar power to the system in 2006 (Robert Weinholzer, Minnesota Department of Transportation, personal communication; *The Post Bulletin 2005*). The system will be evaluated for two years once the power issue has been resolved. In addition, vegetation management in the right-of-way could be reduced if weed mats or gravel strips were situated between the sensors (Erik Lewis, Lewis Enterprises Inc., personal communication). Even though the signs were not activated in 2003 and 2004, the number of deer-vehicle collisions decreased in 2003 and 2004, possibly because of the presence of the (unactivated) signs (Robert Weinholzer, Minnesota Department of Transportation, personal communication).

4.4.11 Kootenay National Park, British Columbia, Canada

In June 2002 an animal detection system was installed along Hwy 93, in Kootenay National Park in British Columbia, Canada, about 60 km (37.2 mi) north of Radium, immediately north of the Dolly Varden Day-use Area (Figures 4.28 and 4.29) (*Kinley, et al. 2003; Newhouse 2003*). The system was designed to detect large animals, specifically white-tailed deer (*Odocoileus virginianus*). ICBC, QWIP Technologies, OCTEC Ltd., Intranstech and FLIR Systems Inc. all provided support for research and development, and Parks Canada helped install the system. The system had standard black on yellow deer warning signs with amber flashing lights on top to warn drivers (Figure 4.28).



Figure 4.28: Warning signal and sign in Kootenay, British Columbia, Canada (Photo: Alan Dibb/Parks Canada)



Figure 4.29: Trailer and camera in Kootenay, British Columbia, Canada (Photo: Tim McAllister)

Two infrared cameras that detect heat, as well as additional equipment, were installed in the right of way (Figure 4.29). The software uses a combination of motion, speed and size to determine whether the warning system should indeed be triggered.

The system, especially the cooling system of the cameras, experienced technical difficulties during the first year (June through October 2002). A modified system with different infrared cameras was installed in May 2003 (Kinley, *et al.* 2003). The road length covered by the system was cut in half – from 2000 m (2180 yd) to 1000 m (1090 yd) – because of the different cameras. The system was tested between 5 September and 14 October 2003 (Kinley, *et al.* 2003). The system was only active from dusk to dawn.

Problems were encountered with the batteries in the generator and the computer. The system performed well on cool nights; it was able to track and detect moving deer. However, on nights after a warm day the false detections were high, up to 43% (Kinley, *et al.* 2003). The system was removed in the fall of 2003.

4.4.12 Indiana Toll Road, Indiana, USA

In April 2002 an animal detection system was installed along the Indiana Toll Road (I-80/90, between mile posts 130-142) just north of Orland, about 10 mi northwest of Angola, in north-east Indiana (Figures 4.30-4.33) (Sedat Gulen, Research Division, Indiana Department of

Transportation, personal communication; Lloyd Salsman, STS, personal communication). The system was designed and integrated by Sensor Technologies and Systems, Scottsdale, Arizona. Michiana Contracting Inc., Plymouth, Indiana, installed the system. The total length covered by the system was 9,654 m (6 mi), but the system was split up in 6 sections of 1,609 m (1 mi) each (IDOT 2003; Sedat Gulen, Research Division, Indiana Department of Transportation, personal communication). A 1,609 m (1 m) long control section follows each 1,609 m (1 mi) section with sensors. Sections with sensors are at mileposts 130-131, 132-133, 134-135, 137-138, 139-140, and 141-142 (Lloyd Salsman, STS, personal communication). The drivers are presented with a flashing beacon and a sign that says “ANIMAL PRESENT WHEN FLASHING” (Figure 4.31).



Figure 4.30: Sign indicating test section on the Indiana Toll Road, Indiana, USA (Photo: Indiana Department of Transportation, Toll Road District)



Figure 4.31: Warning signal and sign on the Indiana Toll Road, Indiana, USA (Photo: Indiana Department of Transportation, Toll Road District)



Figure 4.32: Pole with sensor tubes, cabinet (with circuit boards and batteries) and solar panel on the Indiana Toll Road, Indiana, USA (Photo: Indiana Department of Transportation, Toll Road District)



Figure 4.33: Sign indicating end of test section on the Indiana Toll Road, Indiana, USA (Photo: Indiana Department of Transportation, Toll Road District)

This system is the same as described for the site in Yellowstone National Park (see Section 4.4.14), has experienced similar problems, and did not become operational until 10 October

2004. Minor problems experienced since then include a battery power problem at a station, and reflection of the microwave radio signals off a guard rail (Lloyd Salsman, STS, personal communication). More recently (2005), multiple batteries started to malfunction, potentially as a result of dilution of the battery fluid through frequent fluid level maintenance (Lloyd Salsman, STS, personal communication). Furthermore, two posts with associated equipment were destroyed in two separate incidents when cars ran off the road in 2005 (Lloyd Salsman, STS, personal communication). The replacement costs were estimated at \$68,000 (*Chagrin Valley Times* 2005). This cost, however, includes an inspection of the entire system and the actual replacement costs per station are about \$8,000 (\$4,000 for materials and \$4,000 for installation) (Lloyd Salsman, STS, personal communication).

4.4.13 Wenatchee, Washington, USA

In October 2002 an animal detection system was installed along US 97A (mile post 206), near Wenatchee, Washington (Figures 4.34 and 4.35). The system was designed and built by Parks Gribble (Battelle Laboratories). The system was installed by Parks Gribble and WSDOT. When the far infrared laser beams (wavelength 1500 nano m) were broken along a 213 m (232.2 yd) long road section, yellow flashing beacons on 1.5 by 1.8 m (5 by 6 ft) black on yellow warning signs with a deer profile were activated (*WSDOT 2003a*; *WSDOT 2003b*) (Figure 4.34). Other signs that said “WHEN FLASHING” accompanied the deer signs. When the system was triggered the lights flashed for one minute.

The system suffered from battery power issues and false positives. It was considered too costly to identify the source of the false positives and to address these problems (Jennene Ring, WSDOT North Central Region Traffic Engineer, personal communication; Marion Carey, WSDOT, personal communication). While the cause of the false positives was not always identified, snow plows were known to trigger the system, and there was snow built-up in front of the laser optics (Jennene Ring, WSDOT North Central Region Traffic Engineer, personal communication; Parks Gribble, Battelle Laboratories, personal communication). In addition, there were driveways in the detection zone, which caused detections whenever a vehicle would turn on or off the road (Parks Gribble, Battelle Laboratories, personal communication). A future test site would preferably be along a straight road section, with little or no slopes along the roadside, and no driveways (Parks Gribble, Battelle Laboratories, personal communication). In addition, LED indicators that help line up the laser and spread spectrum radios would be easier to work with (Parks Gribble, Battelle Laboratories, personal communication).

Deer also crossed frequently between the area covered by the system and the warning signs, giving drivers a false sense of security. In addition, deer may have loitered in the right-of-way. If these deer stayed there longer than one minute the signals were turned off, and drivers were no longer warned of their presence. The system was removed in spring 2004 (Jennene Ring, WSDOT North Central Region Traffic Engineer, personal communication).



Figure 4.34: Warning signal and sign in Wenatchee, Washington, USA (Photo: WSDOT, NorthCentral Region)



Figure 4.35: The area approaching the system in Wenatchee, Washington, USA (Photo: WSDOT, NorthCentral Region)

4.4.14 Yellowstone National Park, Montana, USA

In October and November 2002 an animal detection system was installed along a 1,609 m (1 mi) long road section of US Hwy 191 (mileposts 28-29) in Yellowstone National Park south of Big Sky, Montana (Figures 4.36 and 4.37) (*WTI 2002a*; *WTI 2002b*). The system was designed and integrated by Sensor Technologies and Systems, Scottsdale, Arizona. Michiana Contracting Inc., Plymouth, Indiana and Eagle Rock Timber, Idaho Falls, Idaho installed the system. Each transmitter sends a uniquely coded, continuous microwave RF signal (35.5 GHz) to its intended receiver (*STS 2002*; Randy Moore, STS, personal communication). The transmitters and receivers are mounted about 120 cm (4 ft) above the ground, designed to detect elk (*Cervus elaphus*). If this signal is blocked, the receiver sends a UHF radio signal to the master station.

The master station then sends the beacon-on command to the three nearest beacons. Each beacon is situated above a standard elk warning sign and signs that say “WHEN FLASHING” and “NEXT 1 MILE” (Figure 4.36). The flashing beacons alert on-coming traffic that there may be a large animal on or near the road. After the designated timeout period (3 minutes), the master station transmits the beacon-off command to the beacon stations. If the signal is blocked continuously, the beacons will stop flashing after 12 minutes.

The system records every break-of-the-beam, how long it lasted, date, time, and section number (there are six sections on the east side of the road and nine sections on the west side of the road). It was anticipated that these data could be accessed from a remote location through a cell phone modem. However, cell phone coverage has proved to be insufficient for reliable data transmission. In the summer of 2004 the system was linked to a land-based phone line, but remote downloads remained problematic.



Figure 4.36: Original warning signal and sign in Yellowstone National Park, Montana, USA. A sensor is attached on the left side of the post; a cabinet with circuit boards and batteries is attached to the right side of the post. (Photo: Marcel Huijser, WTI-MSU)



Figure 4.37: Activated warning signal and sign with new text sign “WILDLIFE CROSSING” and solar panel in Yellowstone National Park, Montana, USA (Photo: Marcel Huijser, WTI-MSU)

Each station is powered by a stand-alone solar electric power system. Each station configuration has a different power system designed to meet the load requirements of that station. The solar power systems were designed to operate without down time due to darkness and snow cover, but shady spots and snow did cause a power problem at one post. An additional battery was installed to increase storage capacity, and this seems to have solved the problem. The system experiences technological problems, mostly due to problems with the communication system at low temperatures, faulty sensors and circuit boards, and false positives caused by high, moving and wet vegetation and large passing vehicles.

Many hardware and software replacements and modifications have taken place, especially in fall 2003 and in summer and fall 2004. To reduce the number of false positives caused by vegetation and passing trucks, some grass-herb vegetation was mowed and some shrubs were clipped. In addition, software filters were put in place to distinguish between detections caused by vegetation, passing vehicles, and snow versus large animals. Snow spray from snowplows can still trigger the system, however (Randy Moore and Lloyd Salsman, STS, personal communication). The software filters seem to have reduced the number of false positives as of 22 November 2004.

The reliability of the system was tested between January and March 2005. Interpretation of the detection data and comparisons to snow tracking data showed that the system was indeed capable of detecting elk, and it seemed to do so reliably (see Chapter 7). However, there were two

substantial blind spots in the system where a human model was not detected when approaching or leaving the road. This was due to a curve and slope, causing the beam to shoot over the head of the human model. In addition, a broken bracket of one transmitter caused false positives in the adjacent detection zone. The driver warning signs are currently (February 2006) not attached to the system, and the beacons are unplugged.

A car that ran off the road damaged one of the sensors, but the car is unlikely to have received major damage from the equipment. In addition an elk warning sign disappeared, causing MDT to replace the elk silhouette signs with a text sign that may be less of a collectible (Figure 4.37). Personnel from Yellowstone National Park and local residents have expressed their concern with the dimension of the posts and equipment, and the solar panels in particular. The size of equipment is thought to have a negative effect on the landscape quality, and reflection of the sun on the solar panels is considered a nuisance.

4.4.15 Los Alamos, New Mexico, USA

In October/November 2002 an animal detection system was installed along a 30 m (32.7 yd) long section of a road on a restricted access area near Los Alamos New Mexico (Richard Fuhrman, Fuhrman Diversified, Inc., personal communication; Bill Goodson, Goodson and Associates, personal communication; Sherri Sherwood, Ecology Group, Los Alamos National Laboratory, personal communication). The sensors were manufactured by Goodson and Associates, Inc., Lenexa, Kansas. The infra-red break-the-beam system was installed on both sides of the road (Sherri Sherwood, Ecology Group, Los Alamos National Laboratory, personal communication). In addition, video equipment (Fuhrman Diversified, Inc., Seabrook, Texas) was installed to monitor animal movements and to evaluate system reliability.

The system was installed by the project biologists and the manufacturers of the equipment. No major problems occurred during installation, but the sturdiness of the posts for the equipment was a concern. There were no warning lights or signs installed for the drivers, as the animal detection part was to be tested first. The system was put in place because elk numbers and elk-vehicle collisions were relatively high in the area (*LANL 1997; 2004; Biggs, et al. 2004*). Elk frequently crossed the 30 m (32.7 yd) wide area in winter because of a nearby water source, but only if snow levels were high in the nearby mountains.

The sensors seemed to be working well immediately following their installation (Bill Goodson, Goodson and Associates, personal communication). Due to low snow levels in the surrounding mountains, however, elk did not migrate to lower elevations in the winters that followed, and they did not cross the road section with the animal detection system, at least not frequently. Therefore the reliability of the system was not tested on elk, nor was the system evaluated with regard to driver response and a potential reduction in animal-vehicle collisions.

The video equipment was powered by batteries that had to be replaced every 24 hours (Sherri Sherwood, Ecology Group, Los Alamos National Laboratory, personal communication). Eventually it became too much of an effort to continue to replace the batteries, and the equipment was deactivated in February 2003. Furthermore, budget cuts affected the study, and the equipment was removed in May 2003. The posts are still in the ground, and the equipment is still available should additional funds become available in the future.

4.4.16 Thompsontown, Pennsylvania, USA

In May 2004 an animal detection system was installed along a ± 804 m (0.5 mi) long section of Hwy 22/322 (between mile posts 360-361), just east of Thompsontown, Pennsylvania, approximately 56.3 km (35 mi) northwest of Harrisburg (Figures 4.38 and 4.39) (*Edwards and Kelcey 2003*; Pat Wright and Marcel Huijser, WTI-MSU, personal communication). It was a four-lane highway with two lanes in each direction and a grass median. The system was designed and integrated by Oh DEER, Inc., Mason City, Iowa. The cost of the system was \$90,000.

The Pennsylvania Department of Transportation (PENNDOT) and the vendor installed the system. As opposed to a “break-the-beam-system,” the microwave detectors (Figure 4.39) covered the entire right-of-way and were designed to detect white-tailed deer in an area and filter out moving vehicles, swaying branches, rain and snow. The 17 posts (each with 2 sensor units) were placed at approximately 91 m (99.2 yd) intervals along the side of the road, and they operated on solar power. Hardwiring was calculated to cost more than \$50,000; while the cost for solar panels was estimated at \$7,500 (*Edwards and Kelcey 2003*).



Figure 4.38: Warning signal and sign in Thompsontown, Pennsylvania, USA (Photo: Rhonda Stankavich, PENNDOT)



Figure 4.39: Pole with sensors and solar panel in Thompsontown, Pennsylvania, USA (Photo: Marcel Huijser, WTI-MSU)

Standard deer crossing signs (black on yellow) were combined with yellow flashing lights and additional signs that say “USE EXTRA CAUTION WHEN FLASHING” and “NEXT ½ MI” (Figure 4.38). Signs that say “ANIMAL DETECTION TEST AREA AHEAD” and “END TEST AREA” were installed before and after the sensors. The system suffered from integration problems between the animal detection system part and the driver warning part of the system, problems with the power supply and radios, and difficulties distinguishing between moving vehicles and deer or similar sized animals. The system was removed on 31 January 2005.

4.4.17 Herbertville, Quebec, Canada

In the fall of 2004 an animal detection system was installed along Hwy 169 (km marker 32), about 40 km (25 mi) south of Hebertville, Quebec, Canada (Figures 4.40-4.42) (Christian Dussault, Ministère des Ressources Naturelles et de la Faune du Québec – UQAR, Canada, personal communication). The location is about 130 km (81 mi) north of Quebec City. Hwy 169 is a provincial road with a 90 km/h (56 mi/h) speed limit (Christian Dussault Ministère des Ressources naturelles et de la Faune du Québec – UQAR, Canada, personal communication).



Figure 4.40: Warning sign and signals in Herbertville, Quebec, Canada (Photo: Ministère des Transports du Québec)



Figure 4.41: Sensor and electric fence in Herbertville, Quebec, Canada (Photo: Ministère des Transports du Québec)



Figure 4.42: Control cabinet in Herbertville, Quebec, Canada. The upper section of the control cabinet contains the electronics for the electric fence; the lower section contains the electronics for the sensors and warning signals. (Photo: Ministère des Transports du Québec)

The animal detection system was installed in a ± 10 m (± 33 ft) wide gap in an electric fence. The fence (Electrobraid, Yarmouth Nova Scotia, Canada) covered 9 km (5.6 mi) road length on one side of the gap, and 1 km (0.6 mi) on the other side of the gap (Christian Dussault Ministère des Ressources Naturelles et de la Faune du Québec – UQAR, Canada, personal communication). First a laser break-the-beam system was installed. This system was easily triggered (false positives) by sensors that got out of alignment, mostly because of unstable posts and freezing and thawing of the ground.

The laser break-the-beam system was replaced by an active infrared system that also consisted of a transmitter and a receiver (Figure 4.41). The systems were installed on both sides of the road, and the sensors were placed on metal posts (about 1.3 m (4.3 ft) above the ground) on either side of the two gaps. The system was designed to detect moose, and to a lesser extent white-tailed deer and black bear. The infrared system was custom made by an electronic consultant (Service Camera Pro, Quebec City).

The system became operational in the spring of 2005. Large black on yellow warning signs – 1.2 x 1.2 m (3.9 x 3.9 ft) – with a moose silhouette and a flashing light in each of the four corners were installed for both travel directions, approximately 75 m (246 ft) before the gap in the fence (Figure 4.40).

The reliability of the system is being evaluated. Moose have crossed the road at the gap in the fence after system installation (spring 2005). No moose-vehicle collisions have been reported between spring 2005 and February 2006. Some problems with the electronics have occurred; most of them were related to moisture and humidity.

4.4.18 Pinedale, Wyoming, USA

On a 6.4 km (4 mi) long section of US Hwy 191, west of Pinedale, Wyoming, 51 collisions with large animals, mostly migratory mule deer and pronghorn (*Antilocapra americana*), were recorded during a period of 4 years (Cox, *et al.* 2005; Matthew Johnson and Kevin Cox, Wyoming Department of Transportation, personal communication). The 51 animal-vehicle collisions amounted to more than 70% of the total number of crashes on this road section (Cox, *et al.* 2005). In October 2005 an animal detection system was installed along a 2.2 km (1.36 mi) road section in this area (Trapper's Point Bottleneck), between mileposts 105.09 and 106.45, approximately 8 km (5 mi) west of Pinedale, Wyoming (Kevin Cox, Wyoming Department of Transportation, personal communication; Cox, *et al.* 2005). The system was purchased and installed by Interstate Electrical Contractors, Wheatridge, Colorado (Kevin Cox, Wyoming Department of Transportation, personal communication). In order to avoid hindering animal movements, especially of migratory mule deer and pronghorn, there are no fences installed along the road to funnel the animals into the area with the animal detection system (Cox, *et al.* 2005).

The system consists of seismic sensors (geophones) in combination with above-ground passive infrared sensors (Eagle Telonics, Mesa, AZ), similar to the system tested in Nugget Canyon, WY (see Section 4.4.8) (Cox, *et al.* 2005; Kevin Cox, Wyoming Department of Transportation, personal communication). The geophones and the passive infrared scopes need to be triggered at the same time for the warning signs to be activated. The sensors were installed on both sides of the road. The 2.2 km (1.36 mi) long area was divided into three zones, each about 729 m (0.45 mi) long, each with its own warning sign at the beginning of a zone to alert the drivers. Thus there were three signs per travel direction, six in total (Cox, *et al.* 2005). Once an animal is detected, the flashing warning lights on black on yellow warning signs are activated. The warning signs say "WATCH FOR DEER WHEN FLASHING" (Kevin Cox, Wyoming Department of Transportation, personal communication). The lights remain activated for 2 minutes after the last detection has occurred (Cox, *et al.* 2005).

The system became operational in October 2005. A camera and recording system will help validate and calibrate the system (Cox, *et al.* 2005). The camera system allows for remote monitoring from the local WYDOT office in Pinedale. Preliminary results indicate that the aboveground infrared scope is sensitive to sunlight during certain periods of the day. Furthermore, snow thrown by snowplows triggers the geophones (Kevin Cox, Wyoming Department of Transportation, personal communication). The reliability of the system will be investigated further, starting with the spring migration in 2006. Vehicle speeds and the number of animal-vehicle collisions will also be monitored (Kevin Cox, Wyoming Department of Transportation, personal communication).

4.4.19 Norway

Three animal detection systems were installed in Norway in the past, all of which have now been removed (Bjørn Iuell, Miljøseksjonen, Utbyggingsavdelingen, Statens vegvesen Vegdirektoratet, Oslo, Norway, personal communication). Their location, date of installation, and date of removal are unknown to the authors (February 2006). However, the following information was obtained on the three systems (Bjørn Iuell, Miljøseksjonen, Utbyggingsavdelingen, Statens vegvesen Vegdirektoratet, Oslo, Norway, personal communication):

1. The “pioneer project’s” technology was based on “ordinary photocells.” Whenever an animal (moose was the target species) would block the “light beam,” it triggered a “red light” by the road, commanding drivers to stop. Other events, however, also triggered the system, e.g., falling leaves.
2. A system with “infrared sensors” that was triggered by movement, and activated a “red light” on the road. Rapid shifts in light conditions (e.g., scattered clouds on a summer day with strong winds) caused false positives.
3. A system with “laser technology,” was placed in an opening in a wildlife fence. Moose passing through the gap in the fence triggered the system and caused a traffic sign to “unfold.” The “unfolded” sign was accompanied by “blinking lights.” In addition to technical problems, people would stop to take pictures of the animals when the warning signs were activated.

4.5 PLANNED SYSTEMS

In addition to the animal detection and animal warning systems that have been installed (Sections 4.4.1 through 4.4.19), 27 additional locations were identified, for which an animal detection or animal warning system is planned. These include the following:

4.5.1 McDonald Creek Area, California, USA

The California Department of Transportation (CALTRANS), District 1, has identified a 965 m (0.6 mi) long road section along Hwy 101 where elk cross the road frequently. The road section lies between mileposts 114.18 and 115.52, in Redwood National Park, McDonald Creek area, near Orick, approximately 56 km (35 mi) north of Eureka. This area has had a concentration of collisions, resulting in human injuries and dead elk (Susan Leroy, North Region Environmental Management Branch, CALTRANS, personal communication). At this time there is a flashing warning light in place to alert drivers; however, the flashing is continuous, independent of the presence of the elk. Since drivers tend to ignore permanent warning signs, CALTRANS has decided to install an animal detection system and evaluate the effect on driver behavior, vehicle speed and elk-vehicle collisions. Installation is scheduled for 2006.

4.5.2 Preacher Canyon, Arizona, USA

State Route 260 from Payson to the Mogollon Rim in Arizona, northeast of Phoenix, is being widened (*Dodd, et al. 2003*; Norris Dodd and Jeff Gagnon, Arizona Game and Fish Department, personal communication). This road section is known for its high number of collisions with elk. To reduce the collisions and to make the road more permeable to wildlife, 17 bridges and underpasses are being constructed. There are two wildlife underpasses located in Preacher Canyon near Little Green Valley. In addition, wildlife fencing (500 m (545 yd) road length), jump-outs and one-way gates have been provided for. Although the underpasses are used intensively, many elk and white-tailed deer walk along the fence and cross the road at the end of the fence (*Dodd, et al. 2003*). This has been demonstrated through infrared video images. In addition, the Arizona Game and Fish Department has tracked elk movements and highway crossings through GPS telemetry and has assessed the wildlife-vehicle collision rate for nearly two years. This monitoring will be conducted an additional two years after fencing. Furthermore, the Arizona Game and Fish Department has proposed to install animal detection systems at two fence ends in the Preacher Canyon area, on both sides of the road. One section is 1-1.2 km (0.62-0.75 mi) in road length, and the other measures about 1.5 km (0.93 mi) (Norris Dodd, Arizona Game and Fish Department, personal communication).

4.5.3 Durango, Colorado, USA

A section of US Hwy 160 between Durango and Bayfield, Colorado has a history of animal-vehicle collisions, mostly with mule deer. The road section between mile marker 94.77 and 100 has an average of 15-20 mule deer-vehicle collisions per mi per year. About 61% of all accidents along this road section are wildlife related (John Holst, Colorado Department of Transportation, personal communication). An animal detection system will be installed between mile marker 94.77-95.77 (Jason Osaki and John Holst, Colorado Department of Transportation, personal communication). In addition, brush will be cleared from the right-of-way, starting at mile marker 94.77 and ending at 98.3. The road section between mile marker 99 and 100 will serve as a control (John Holst, Colorado Department of Transportation, personal communication). The effectiveness of the system will be measured by monitoring vehicle speed and animal carcasses in the road sections concerned (*Coltharp 2005*).

4.5.4 Tijeras Canyon, New Mexico, USA

Tijeras Canyon is located just east of the eastern city limits of Albuquerque, New Mexico. Tijeras Canyon is a major north-south wildlife corridor with perennial waters in the bottom (Tijeras Creek). The canyon separates two mountain ranges, the Sandia and Manzano Mountains (*Marron and Associates, Inc. 2005*; Mark Watson, New Mexico Department of Game and Fish, personal communication). The Sandia Mountains are becoming increasingly isolated by human development from all directions. I-40 and NM 333 (formerly old historic Route 66) bisect the north-south wildlife corridor with a combined 8 lanes of traffic, with limited existing permeability for wildlife.

NMDOT's proposed I-40 improvement project will widen I-40 and install 120 cm (4+ ft) high "Texas-style" median barriers with reflectors on top, both between and on the outside of the east and west-bound lanes of I-40 (Mark Watson, New Mexico Department of Game and Fish,

personal communication). In addition, fencing of I-40 through Tijeras Canyon will occur, and large game animals will be funneled through a series of four existing underpasses and one (slightly) modified culvert (*Marron and Associates, Inc. 2005*).

In addition, a 6.4 km (4.0 mi) section of State Route NM 333 has a history of collisions with mule deer and black bears and occasionally cougars (Mark Watson, New Mexico Department of Game and Fish, personal communication; *Marron and Associates, Inc. 2005*). The road section concerned runs through the Village of Carnuel, and stops at the western edge of the Village of Tijeras. Mule deer, black bear and cougar all pose a risk to driver safety on I-40 or NM 333.

There are two areas that will be equipped with an animal detection system along State Route NM 333 (Mark Watson, New Mexico Department of Game and Fish, personal communication). The systems are to reduce animal-vehicle collisions on State Route NM 333 as large animals move across this highway and are funneled under I-40 by the fencing (*Marron and Associates, Inc. 2005*). The first area is at Deadman's Curve where a large canyon funnels animals down to State Route NM 333. This area is about 100 m (328 ft) long. The second area is a single paved 6.1 m (20 ft) wide underpass beneath I-40.

The wildlife mitigation measures included in this project are implemented by NMDOT. The mitigation measures aim to reduce wildlife-vehicle collisions and increase habitat permeability, especially for large animals such as mule deer, black bear and cougar. The proposed mitigation on State Route NM 333 is in conjunction with the NMDOT Interstate 40 project (beginning of project MP 170.353) east of the Carnuel Interchange, extending east for 6.35 km (3.946 mi) and ending at MP 174.299 west of Tijeras Interchange (Mark Watson, New Mexico Department of Game and Fish, personal communication). The preparations for system installation will start in June 2006, and system installation is anticipated in the fall of 2007.

4.5.5 Wells, Nevada, USA

The Nevada Department of Transportation is planning to install an animal detection system around mile post 95 along I-80, in Elko County, about 48 km (30 mi) east of Wells (Jay van Sickle, Nevada Department of Transportation, personal communication). This location has a history of mule deer-vehicle collisions. The length of the road section that is to be equipped with an animal detection system is ≤ 3.2 km (≤ 2 mi). There will be wildlife fencing guiding the animals towards the mitigated road section. The intention is to install the system in spring 2007.

4.5.6 Flagstaff, Arizona, USA

A section of I-40 west of Flagstaff, Arizona, USA (mile marker 148-222), has an average of 0.5 elk and 0.4 deer collisions per mile per year. In addition, a section of I-17, south of Flagstaff (mi marker 308-340), has an average of 2.0 elk and 0.6 deer collisions per mile per year. An elk-vehicle collision on I-40 (near mile post 211) east of Flagstaff resulted in a high profile lawsuit (Terry Wilson, Sensor Technologies and Systems, personal communication; *Arizona Court of Appeals 2004*). The State of Arizona is planning to install an animal detection system on I-40 or I-17 near Flagstaff. The initial suggestion is a 16.1 km (10 mi) section on I-40 (between mile posts 168 and 180), west of Flagstaff (Terry Wilson, Sensor Technologies and Systems, personal

communication). The system is to reduce animal-vehicle collisions, especially with elk and mule deer.

4.5.7 Maine, USA

Ungulate-vehicle collisions are a major safety concern in Maine. There are two locations that are potential candidates for the installation of animal detection systems: Hwy 1 between Presque Isle and Caribou, and an 804 m (0.5 mi) long road section on Hwy 4 near Rangeley (Robert van-Riper, Maine Department of Transportation, personal communication). Both locations have a history of ungulate-vehicle collisions with moose as well as white-tailed deer.

4.5.8 Weerterbosch, The Netherlands

Red deer will be re-introduced in a forested area (Weerterbosch) in the Netherlands, about 4 km (2.5 mi) northwest of Weert. The first animals will be introduced in an enclosure in 2006. Several years later the animals will be allowed to roam freely in the Weerterbosch. Several animal detection systems will be installed along the roads in and nearby the Weerterbosch: along the road from Maarheeze to Hugten and Someren (Koenraadweg / Heibloemstraat), and along the road from Nederweert to Someren (Booldersdijk) that connects to the Heibloemstraat (*Eindhovens Dagblad 2005*).

4.5.9 15 Sites, Germany

Fifteen (15) sites are currently in the planning phase in Germany (Giacomo Calonder, Calonder Energy, Switzerland, personal communication). One of these sites is in Wommen, Hessen: an animal detection system is planned along the B400 near Wommen, Hessen. This road has not been built yet. The road section concerned will parallel the A44 motorway. The A44 has a wildlife overpass at this location already, and the animal detection system is to provide for a safe passage across B400 for the animals that use the overpass across the motorway. Another overpass across the B400 was deemed too expensive. The system will be installed in a 300 m gap in a fence that goes out about 1 km to either side (Bertram Georgii, VAUNA e.V., Oberammergau, Germany, personal communication). The system should detect red deer, roe deer, wild boar, lynx and, if the system allows, smaller species such as wild cat, badger, hare etc. No further details are available for the other 14 sites.

4.5.10 ≥ 4 Sites, Switzerland

Four new sites are in the planning phase in Canton Tessin, Switzerland. An unknown number of sites are in the planning phase in Canton Graubunden (region Savognin - Julier) (Jann Romer, Infodienst Wildbiologie and Oekologie, Swiss Wildlife Information Service, personal communication).

4.6 ADDITIONAL ISSUES

During installation, operation and maintenance of the systems discussed in this chapter a range of problems and other issues were identified (see Section 4.4). The authors have grouped them

into four categories: false positives, false negatives, maintenance, and landscape, ecology and animals. Table 4.3 shows that area-cover and break-the-beam systems seem to be particularly vulnerable to false positives and false negatives.

Table 4.3: Summary of issues, problems, and experience with operations

Issues, Problems, and Experiences	Area cover systems	Break-the-beam systems	Geo-phone system	Radio-collar system
False positives				
High, moving or wet vegetation	√	√		
Flying birds, nesting birds, rabbits	√	√		
Wind, rain, water, fog, snow spray, falling leaves	√	√	√	
Snow and ice accumulation on sensors or ground	(√)	√		
Microwave radio signal reflection off guard rail		√		
Sun, heat, unstable sensors	√	√	√	
Insufficient ventilation in box (fog on lens)	(√)	√		
Frost, low temperatures	√	√		
Lightning	(√)	√	√	(√)
Long distance between transmitter and receiver		√		
Traffic on road	√	√	(√)	
Traffic on driveways or side road	(√)	√		
Passing trains			√	
Signals from other transmitters		√		√
False negatives				
Curves, slopes not covered by sensors	(√)	√		
Loitering animals in right-of-way not detected	(√)	√	(√)	
None of the individuals that cross have collars				√
Not feasible for non-gregarious species / migrants				√
Insufficient warning time	(√)	(√)	(√)	
Some systems are only active during the night	√	√		
Maintenance				
Maintenance costs (e.g., mowing, power, fences)	(√)	√	(√)	(√)
Shade/snow on solar panels	(√)	√	(√)	(√)
Vandalism and theft of e.g., solar panels	(√)	√	(√)	(√)
Safety (cars of road)	(√)	√	(√)	(√)
Broken sensors, warning lights or other material	√	√	(√)	√
Period required to solve technical difficulties	√	√	√	√
Signs (standardization, liability)	√	√	√	√
No remote access to data (poor cell phone coverage)	(√)	√	√	(√)
Landscape, ecology, animals				
Landscape aesthetics	(√)	√	(√)	(√)
Animals crossing areas may change overtime	(√)	√	(√)	(√)
Animals may wander between fences (if present)	√	(√)	(√)	(√)
Small animals are not detected	√	√	√	√
Continuous effort to capture animals				√
Stress for the animals involved				√
Not in habitat linkage zones (light disturbance)		√ ¹		

√ = problem has been reported or issue applies

(√) = problem has not been reported, but it could occur

¹ for Swedish system that illuminates the road and right-of-ways once an animal is detected

False positives occur if the system is triggered by causes other than the presence of large animals (target species). False negatives occur if a large animal is present, but the system fails to detect it. This also emphasizes an important limitation of animal detection systems; they are only intended to detect certain large species, and they do not attempt to detect relatively small species.

Most of the causes of false positives and false negatives have already been discussed (Section 4.4); but some have not been explicitly mentioned yet or require additional explanation. For example, cars on driveways or side roads can trigger area-cover detector systems and break-the-beam systems. If the driveways or side roads receive only little use, one could decide to accept a certain number of false positives. Another strategy is to accept a certain number of “gaps” in the detection system at the location of the driveways or side roads.

Another problem occurs when animals pass the sensors and then loiter in the right-of-way or on the road. Most animal detection systems do not detect the animals once they have passed the sensors. This results in false negatives, as the warning signs are typically switched off within a couple of minutes. Other false negatives can occur if the sensors are placed close to the road and if the animal approaches the road very quickly.

If the warning signs are placed at relatively great intervals drivers may not pass a warning sign before they are confronted with a large animal. This potential problem could be addressed by installing warning signs at short intervals. Another option is to install animal detection systems at short road sections in combination with a fence that funnels the animals through the narrow crossing area.

Radio collar systems such as the one in Sequim (Section 4.4.9) can also produce false negatives. It is unlikely that all the individuals in a certain area can be equipped with radio collars. As a consequence, the animals without radio collars are only detected if one or more radio-collared animals accompany them. Therefore the system only works well for highly gregarious species and not for solitary ones. The system also works much better for a resident population than for migrants from far away locations that may only cross the road once or twice per year. The radio-collar system also requires re-collaring effort. The batteries of the radio collars usually run out after several years and then must be replaced. In addition, individuals may die as a result of hunting, injuries or old age. Although experts usually minimize the stress for the animals during capturing and handling, they are exposed to a certain amount, and some stress continues as a result of carrying a radio collar.

All systems have or can have a wide variety of maintenance issues. In addition, most systems require a period during which major technical problems are identified and hopefully solved. The presence of posts and equipment in the right-of-way may also be a problem on its own. Animal detection systems and animal warning systems may help reduce the number of animal-vehicle collisions, but they are also a potential safety hazard to vehicles that run off the road. This could lead to liability claims. Finally, as more animal detection and animal warning systems are installed, signage will have to be standardized.

Another limitation of most systems (with microwave radar as the only likely exception) is the inability to determine the direction in which the animal is moving. This leads to a warning when an animal is leaving the side of the road, and this could be considered a false detection. On the

other hand, animals may decide to turn around and approach the road again, which results in shorter warning times for drivers. This could be an argument for detecting all animals that are on or near the road, regardless of whether they are approaching or leaving.

4.7 DISCUSSION AND CONCLUSION

This overview shows that a wide variety of animal detection systems have been installed across North America and Europe. Many of the systems encountered technical problems or experienced false positives, false negative or maintenance issues. This was to be expected, since most animal detection and animal warning systems are new applications of relatively new technology. In addition, the systems are typically exposed to rain, snow, heat and frost. A few systems seem to have resolved most of the problems and operate well. Examples of successful systems are the Swiss system (Sections 4.4.1, 4.4.4, and 4.4.5), the Finnish system (Sections 4.4.2 and 4.4.3) and, although still in an experimental stage, the geophone system (Sections 4.4.8 and 4.4.18) and the radio collar system (Section 4.4.9). The systems in Indiana and Montana (Sections 4.4.12 and 4.4.14) seem to be reliable as well (see also Chapter 7), but there are no data yet with regard to system effectiveness (anecdotal or well documented). Each system type has its own (potential) strengths and weaknesses, and one has to review them carefully before installing a system in a particular location.

It is important that animal detection systems produce very few false positives and false negatives. False positives may cause drivers to eventually ignore activated signs, and false negatives present drivers with a hazardous situation. Driver response through reduced vehicle speed or increased alertness determines how effective animal detection systems really are. Previous studies have shown that drivers do not always substantially reduce their speeds in response to activated warning signs (*Muurinen and Ristola 1999; Gordon and Anderson 2002*). Drivers may only reduce their speeds when road and weather conditions are bad or when the warning signs are accompanied with a maximum speed limit sign (*Muurinen and Ristola 1999; Kistler 1998*).

However, failure to substantially reduce vehicle speed under all circumstances does not necessarily make animal detection systems ineffective. Minor reductions in vehicle speed are important too, since a small decrease in vehicle speed is associated with a disproportionately large decrease in the risk of a fatal accident (*Kloeden, et al. 1997*). In addition, activated warning signs are likely to make drivers more alert. Driver reaction time to an unusual and unexpected event can be reduced from 1.5 sec to 0.7 sec if drivers are warned (*Green 2000*). Assuming a vehicle speed of 88 km/h (55 mi/h), increased driver alertness can reduce the stopping distance of the vehicle by 21 m (68 ft) (see Chapter 3).

Only two studies have addressed the ultimate parameter of system effectiveness. *Kistler (1998)*, *Romer and Mosler-Berger (2003)* and *Mosler-Berger and Romer (2003)* have shown that the passive infrared detection systems in Switzerland (Section 4.4.1) were able to reduce the number of animal-vehicle collisions by 82% (see Chapter 3). This is an encouraging result, but further evaluation of different systems under different circumstances is required before the conclusions of these studies can be generalized.

In conclusion, animal detection and animal warning systems have the potential to be an effective mitigation tool. However, animal detection and animal warning systems are not the perfect solution for every location. They are one tool in the transportation professional's arsenal and should be implemented only in situations where they are more desirable than other mitigation techniques. In addition, further research and development is needed before animal detection and animal warning systems can be applied on a wide scale.

5.0 ANIMAL DETECTION SYSTEMS AND SITES IN MONTANA AND PENNSYLVANIA

Authors: Marcel P. Huijser, Patrick T. McGowen, and Patrick Wright
Western Transportation Institute, Montana State University
P.O. Box 174250, Bozeman, MT 59717-4250 (e-mail: mhuijser@coe.montana.edu)

5.1 INTRODUCTION

Chapter 5 details the two experimental animal detection systems, the two study sites selected for a field test, and the roles and responsibilities of the project partners and subcontractors.

5.2 FIELD SITES

The members of the Technical Advisory Committee (TAC) provided a list of potential sites for installing two experimental detection systems. Several sites were considered in Alaska (1 site), Indiana (8 sites), Iowa (5 sites), Kansas (1 site), Montana (2 sites), Oregon (1 site) and Pennsylvania (1 site). The sites were reviewed with regard to the following parameters:

- a. Animal-vehicle collisions. The site should have a history of a relatively high number of animal-vehicle collisions with large animals, especially ungulates (e.g., deer, elk or moose). Road kill monitoring data should be available before and after installation of the animal detection system.
- b. Animal movements. The site should preferably be located in an area where many large animals (e.g., deer, elk or moose) are known to cross the road (daily movements or seasonal migration). Note: not all animal movements across a road result in animal-vehicle collisions.
- c. Terrain. The terrain has to allow for the installation of an animal detection system. For example, an abundance of ridges, gullies and rocky outcrops may make a location less suitable for an animal detection system. Difficult terrain may also require more sensors and other equipment than relatively flat areas would require. On the other hand, the terrain should not be completely level either, as that would not be representative of many locations that have a concentration of animal-vehicle collisions.
- d. Access roads. The number of access roads should be kept to a minimum to avoid gaps (blind spots) or excessive false positives caused by traffic turning on or off the road.
- e. Vegetation. The vegetation should allow for the installation of an animal detection system. For example, bushes and trees that grow up to the edge of the pavement increase the chance of triggering the system, i.e., they would cause excessive false positives for most area cover or break-the-beam systems.
- f. Length road section. The road section must be at least 805-1609 m (0.5–1.0 mi) long.

- g. Changes in road or landscape. The road and surrounding landscape should not be scheduled to undergo major changes within the research period. Major changes, other than the installation of the animal detection system, would confound the results of the study.
- h. Project partners. All the organizations and individuals that have jurisdiction or that are stakeholders in activities at the study site should support the project. This includes support for installation, operation and maintenance.
- i. Public visibility. The site should preferably have good local or regional, perhaps even national, public visibility.
- j. Travel costs. The site should preferably be close to where vendors and WTI-MSU staff are located. This reduces costs for travel and stay.
- k. Power. The site should allow for either solar power or a connection to 110 V power source.
- l. Pull-out. The site should preferably have a safe pull-out location for vendors and maintenance and research personnel.
- m. Access. The site should preferably have a low risk of theft and vandalism, e.g., a controlled access road.

After review and discussion, the TAC selected the following sites: US Hwy 191, in Yellowstone National Park, Montana (MT), and Hwy 22/322, near Thompsontown, northwest of Harrisburg, Pennsylvania (PA). The MT site stood out because of its national visibility, representative terrain and vegetation (forested hills and mountains), the abundance of large mammals, especially elk, and its proximity to the office of WTI-MSU. Despite the selection of this site, some concerns remained with regard to snow accumulation and associated challenges, as well as landscape aesthetics. The PA site ranked high because of the large number of animal-vehicle collisions, controlled access, limited fluctuations of the deer population because it borders private land with restricted hunting, relative proximity to the vendor (Mason City, Iowa; see Section 5.2.6), and the terrain, vegetation and large animals (white-tailed deer) that seem representative for eastern states.

5.2.1 US Hwy 191, Yellowstone National Park, MT

The site is located along US Hwy 191 in Yellowstone National Park, between mile marker 28.0 and 29.0 (Figures 5.1 and 5.2). This two-lane road is located in a valley and runs parallel to the Gallatin River. The lands on the east side of the river in this area are part of Yellowstone National Park. The lands on the other side of the river are mostly National Forest lands. The valley is dominated by grasslands and shrubs along the river banks, while adjacent mountain slopes are mostly forested.

Figure 5.1 represents the location of the animal detection system. Starting around the parking area for the trailhead, the north end of the site has trees, mostly lodgepole pine (*Pinus contorta*) on both sides of the road within 9 m (30 ft) from the pavement. The rest of the road section is more open and has steep slopes for the road bed, especially on the west side of the road. A section of private land, the Black Butte Ranch, is located adjacent to part of the study site on the west side of the river. The access road to the ranch connects to US Hwy 191 about midway in the test site (Figure 5.1). The parking area for a trailhead is also located on the west side of the road, about 600 m (0.37 mi) farther to the north. The trail itself starts on the east side of the road.

Furthermore there is a pullout on the west side of the road about 150 m (493 ft) south of where the access road to the ranch connects with US Hwy 191. The elevation of the site is about 2,073 m (6,800 ft), and annual average snowfall is about 305 cm (120 in). Winter driving conditions include heavy snowstorms and an icy and snow packed road surface with heavy winds and temperatures well below -30 °C (-22 °F).

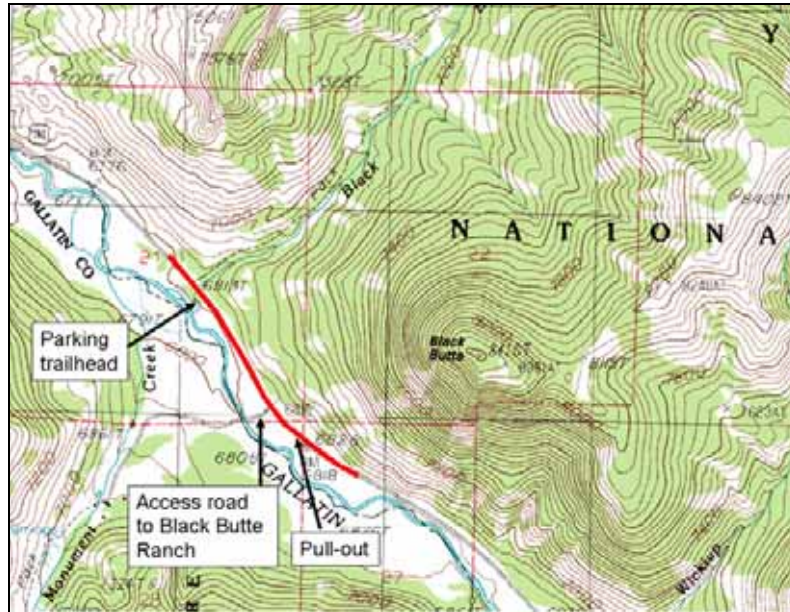

Figure 5.1: Animal detection system location along US Hwy 191

The red section in Figure 5.1 represents the road section with the 1,609 m long (1 mi) animal detection system between mile markers 28.0 and 29.0. A view of the road, looking towards the north, about 150 m (500 ft) north of where the access road to the Black Butte Ranch connects with US Hwy 191 is shown in Figure 5.2. The forested slopes are visible to the right (east side of the road) and the frozen Gallatin River is visible to the left (west side of the road). The valley bottom is dominated by grasses and shrubs along the river banks (Figure 5.3).



Figure 5.2: View of US Hwy 191 looking north (Photo: Marcel Huijser, WTI-MSU)



Figure 5.3: The grasslands and shrubs along the Gallatin River at the MT site (Photo: Marcel Huijser, WTI-MSU)

US Hwy 191 has two 3.7 m (12 ft) wide travel lanes with an asphalt road surface. The shoulder width varies between 0.6-1.2 m (2-4 ft). The clear zone is usually 6.1 m (30 ft) wide, but steep slopes are much closer to the road along certain sections. The right-of-way on the west side of the road has a steep slope for about 500 m (0.31 mi) (Figure 5.2). The road has some curves within the section with the animal detection system. The speed limit is 88 km/h (55 mi/h), but the actual average vehicle operating speed is around 113 km/h (70 mi/hr) (Gunther, et al. 1998; speed readings by WTI-MSU, November 2002). The average annual daily traffic volume (AADT) is about 2,545 vehicles with about 13% truck traffic (estimated in 2000). Traffic volume peaks in July (4,400 ADT), mostly because of tourists that visit the area.

The area is home to many large mammal species including elk (*Cervus elaphus*), moose (*Alces alces*), bison (*Bison bison*), mule deer (*Odocoileus hemionus*), white-tailed deer (*O. virginianus*), black bears (*Ursus americanus*), grizzly bears (*U. Arctos*), coyotes (*Canis latrans*) and wolves (*C. lupus*). The majority of the recorded animal-vehicle collisions in this area involve elk. Table 5.1 shows the number of animal-vehicle collisions between 1989 and 1998 at and adjacent to the site with the animal detection system (Source: Yellowstone National Park).

Table 5.1: Number of animal-vehicle collisions

Mile marker	Total recorded road kill	Moose	Elk	Mule deer	Black bear	Wolf	Coyote	Beaver	Raccoon
27-28	38	0	30	4	0	0	2	2	0
28-29	67	2	56	2	0	1	5	0	1
29-30	29	1	21	1	1	1	4	0	0

The valley and surrounding slopes are an important wintering area for elk, and most elk-vehicle collisions occur during the winter season (source: Montana Department of Transportation; Yellowstone National Park). However, the number of elk wintering in the valley and along US Hwy 191 and the number of elk-vehicle collisions may have decreased during the last several years (Russel Rooney, Montana Department of Transportation, personal communication). It may be that this reflects a true decrease in population size, but it is also possible that the elk are more dispersed than before, perhaps because of the presence of wolves in the area (*White and Garrott 2005*).

Currently most of the elk seem to move across the road in the fall (November-mid December) when they migrate to lower elevation areas and in the spring when they migrate to higher elevation areas as the snow melts off (mid March-mid May). Elk that spend the winter along the Gallatin River and the surrounding slopes typically spend the day bedded down on the forested slopes (Greg and Sara Knetge, caretakers Black Butte Ranch, personal communication; John Winnie, Montana State University, personal communication). In the evening the elk travel down the slopes to the valley bottom to forage on grasses and shrubs along the river. In the early morning hours they move up the slopes again. Hence there seems to be a concentration of elk crossing the road in the evening and early morning.

5.2.2 Hwy 22/322, near Thompsontown, PA

The site is located along Hwy 22/322, just east of Thompsontown, PA about 56 km (35 mi) northwest of Harrisburg (Figure 5.4, Figure 5.5 and Figure 5.6). This road has no mileposts; PennDOT uses a road segment system. The animal detection site covers the following road segments: eastbound, 0400/1938 to 0420/0000; and westbound, 0401/2500 to 0421/0000. Figure 5.4 shows the location of the animal detection system along Hwy 22/322. The red section represents the road section with the 805 m long (1/2 mi) animal detection system.

The road cuts through a series of ridges and valleys, and parallels the Juniata River. The ridges are mostly forested, while the valleys are dominated by agricultural lands, small towns and isolated farm buildings. The land in this area is mostly privately owned. The road section with

the animal detection site cuts through agricultural lands, with shrubs and trees at the edge of and within the right-of-way and a grass strip next to the edge of the pavement. The elevation of the site is about 150 m (500 ft). Annual precipitation is 762 mm (30 in). Winter driving conditions include sleet, hail, and snowstorms, and the roadway is occasionally icy.

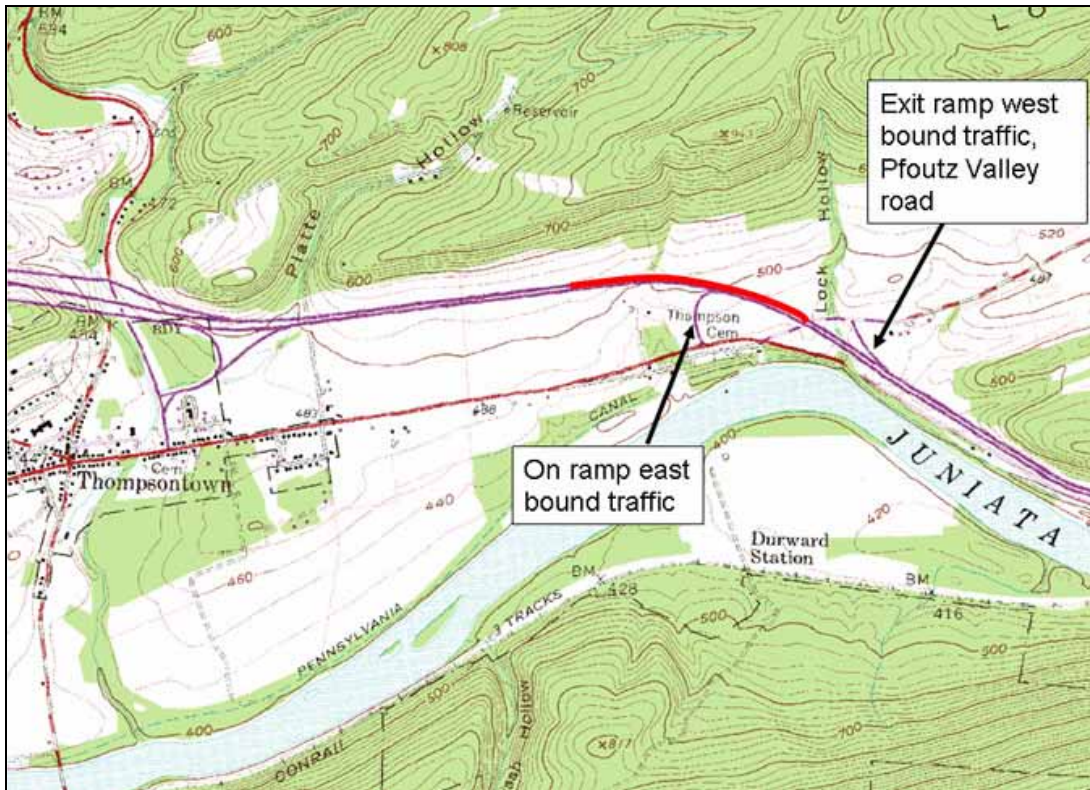

Figure 5.4: Animal detection system location Hwy 22/322

Hwy 22/322 is a controlled access highway and has an exit ramp (Pfoutz Valley Rd) for westbound traffic just before the first sensor location at the southeast side of the test section. In addition, there is an entrance for eastbound traffic within the road section (about halfway). Hwy 22/322 is a concrete four-lane divided highway (two lanes in each direction). The width of the right-of way varies between about 30-35 m (100-115 ft). Lane width is approximately 3.7 m (12 ft), and the median width is about 18 m (60 ft). The shoulder width varies between 1.2-3.0 m (4-10 ft). The clear zone is about 9.1 m (30 ft). The right-of-way for eastbound traffic has a steep slope west of the entrance to Hwy 22/322.

The road has a bridge on the south side (across the Pfoutz Valley Rd). The road also has a gentle curve and goes up a hill on the west side (downhill for eastbound traffic). The posted speed limit is 105 km/h (65 mi/h). The average annual daily traffic volume (AADT) is about 6,882 for eastbound traffic and about 6,953 for westbound traffic (13,835 for both directions combined) with about 26% truck traffic (estimated in 2002). Traffic volume peaks in June (8,044 ADT).

White-tailed deer are abundant in this area, and they are exposed to only limited hunting. The majority of the recorded animal-vehicle collisions in this area involve white-tailed deer. Maintenance personnel from the Pennsylvania Department of Transportation (PennDOT) estimate that approximately 70 white-tailed deer carcasses are removed every year along a 1.8 km (1.1 mi) long road segment just east of Thompsettown. The animal detection system covers 805 m (0.5 mi) of this road section. Most of the collisions with white-tailed deer occur in October and November, which coincides with the rut and hunting season. PennDOT maintenance personnel state that the deer typically cross the road as they move between the forested ridge and the agricultural lands in the valley bottom.

Figure 5.5 and Figure 5.6 show a view of the westbound lanes, just northwest of the bridge across the Pfoutz Valley Rd. The agricultural lands and forested ridge are visible in the background



Figure 5.5: View of Westbound Lanes Hwy 22/322, Thompsettown, PA (Photo: Marcel Huijser, WTI-MSU)



Figure 5.6: View of Westbound Lanes Hwy 22/322 facing southeast, Tompsonstown, PA (Photo: Marcel Huijser, WTI-MSU)

5.3 ANIMAL DETECTION SYSTEMS

Animal detection system technologies were identified through a literature review, interviews with researchers and managers involved with other animal detection system projects, and responses from vendors to a Request for Information (RFI) (Farrell 2002; Farrell, et al. 2002; Robinson, et al. 2002) (see Appendix D). A Request for Proposals (RFP) was published in August 2000. The Technical Advisory Committee (TAC) evaluated the proposals with regard to:

- Proposed approach of the vendors,
- Vendor qualifications,
- Requirements listed in the RFP, and
- Costs.

Two vendors were selected to design and deliver an animal detection system: Sensor Technologies and Systems (STS) for the Montana site and Oh DEER, Inc. for the Pennsylvania site (see Appendix E for addresses).

5.3.1 STS Animal Detection System (MT site)

STS designed a system based on a break-the-beam principle. Break-the-beam systems consist of transmitters that send modulated signals to receivers. In this case the signal consists of low power microwave radio signals (around 35.5 GHz) (STS 2002). When an animal's body breaks the beam, the receiver signal output is decreased, indicating a detection event. The paired

transmitters and receivers (sensors) cover 1609 m (1 mi) along US Hwy 191 between mile marker 28.0 and 29.0 (Figure 5.7).

Break-the-beam systems require a clear line of sight between a transmitter and its receiver. The maximum range of the transmitters is 402 m (1/4 mi). Thus, under ideal conditions, 4 sensor pairs (4 detection zones) are needed to cover one mile on one side of the road. However, curves, slopes and vegetation usually require additional sensors. The site along US Hwy 191 has a total of 15 detection zones (6 on the east side, 9 on the west side). Figure 5.7 shows the layout of the animal detection system (Source: STS).

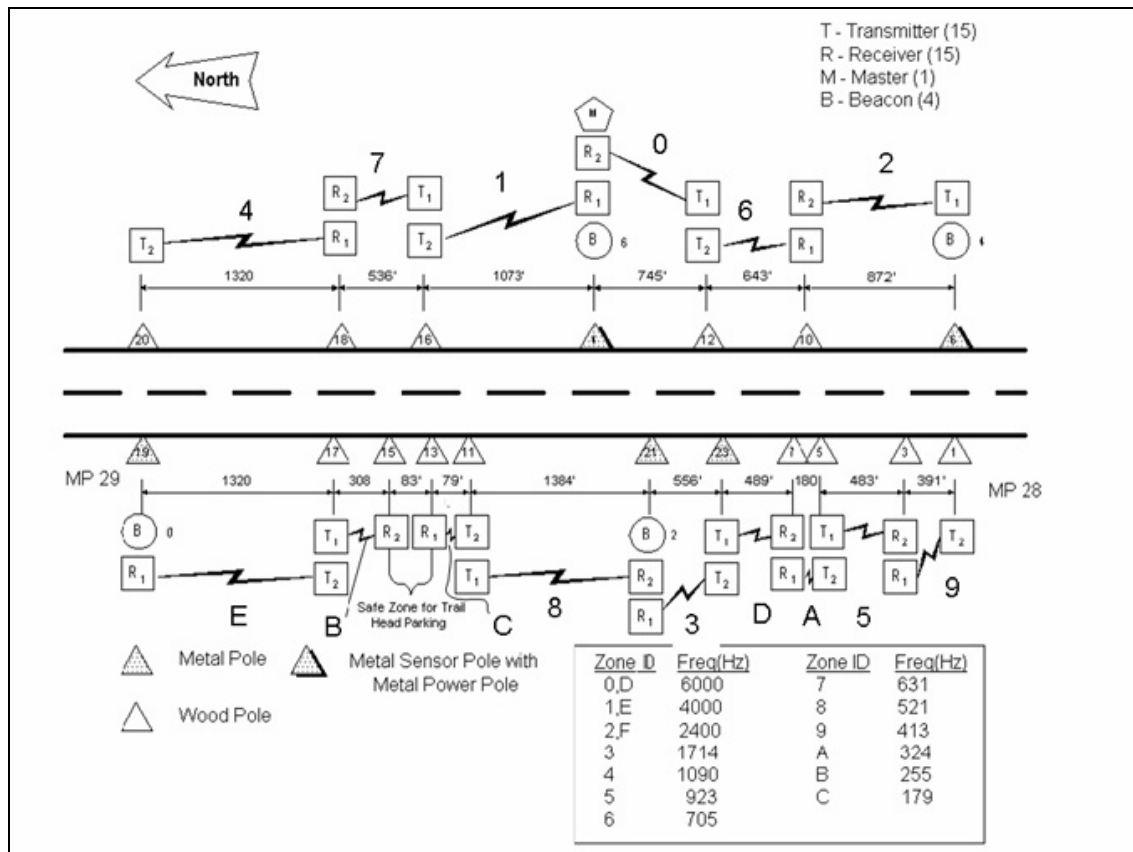

Figure 5.7: Layout of animal detection system US Hwy 191 (Source: STS)

The sensors are attached to metal or wooden poles, dependent on the total weight, size and height of the equipment and poles. Most of the metal and wooden poles are located in the clear zone, 1-8 m (3.3-26.3 ft) from the edge of the pavement. The metal posts have concrete foundations and a break-away system. The wooden poles are placed directly into the ground with three holes located just above ground level allowing them to break-away in case of a collision.

Poles with sensors are referred to as “stations.” A station typically has either two transmitters or two receivers, facing in opposite directions (Figure 5.8). There are nine transmitter stations, and

nine receiver stations. One of these receiver stations also serves as the master station (see next paragraph in this section). Each station is powered by its own solar panels. In some cases the solar panels are mounted on a separate post to avoid tree shade or to reduce weight and size for the pole with the sensors. Batteries provide power during periods of darkness or snow cover on the solar panels, and the battery charge is maintained by the solar panels.



Figure 5.8: The sensors at one of the stations at the MT site. The cabinet contains a circuit board and batteries. (Photo: Marcel Huijser, WTI-MSU)

Most of the sensors are mounted about 1.2 m (4 ft) above the ground as this system is designed to detect elk. However, some sensors are higher or lower to compensate for slopes, rises and low areas in the right-of-way. The ‘beam’ of microwave radio signals is relatively narrow (3°) when it leaves the transmitter, and becomes several meters (yards) wide farther way from the transmitter. When an animal’s body breaks the beam in one of the detection zones, the receiver signal output is decreased, indicating a detection event. The receiver station then sends an UHF radio signal to the master station (station 4; a receiver station) to report the detection (see diagram in Figure 5.7 and photo in Figure 5.9). Upon receiving the detection report, the master station sends a UHF signal to activate the flashing amber warning lights that are located on four of the stations.



Figure 5.9: The master station at the MT site (Photo: Marcel Huijser, WTI-MSU)

When activated the flashing lights alert the drivers that a large animal may be on or near the road at that time. There are four stations with warning lights: station 19 and 21 for southbound traffic and station 6 and 4 for northbound traffic (see diagram Figure 5.7). The warning lights are accompanied by black on yellow warning signs that say “WILDLIFE CROSSING,” “NEXT 1 MILE” (or “NEXT ½ MILE”), “WHEN FLASHING” (Figure 5.10).

The system is programmed to activate the three warning lights that are closest to the zone in which the detection occurred. If no new detections occur, the warning lights are turned off after three minutes. If the signal is blocked continuously for more than 12 minutes, the warning lights are also deactivated. Drivers are informed of the presence and function of the system by white on green information signs, one for each travel direction, about 322 m (0.2 mi) before the first station. The signs say “ANIMAL DETECTION TEST SECTION AHEAD” (Figure 5.11). There is another white on green informative sign for each travel direction that says “END TEST SECTION” at the last station (Figure 5.12).



Figure 5.10: Activated warning signal, text sign “wildlife crossing” and solar panel at the MT site (Photo: Marcel Huijser, WTI-MSU)



Figure 5.11: Sign announcing the test area at the MT site (Photo: Marcel Huijser, WTI-MSU)



Figure 5.12: Sign marking the end of the test section at the MT site (Photo: Marcel Huijser, WTI-MSU)

The system records all detections and saves them at the master station. Detection events are broadcast using the UHF radio system, in real-time, so that the animal detection system operation can be monitored on site using a portable data radio connected to a laptop computer. The system also saves the date and time for each change in beam status (i.e., the beginning and end of a break-of-the-beam are recorded as two changes in beam status), the zone in which the detection occurred, and a code for the activation of the flashing warning signals. In addition, the logging system maintains and reports statistics associated with the operation of individual elements of the system. These statistics include radio link failures, radio link signal levels, beam break summaries, and logging memory status. The data can be downloaded on-site (memory card, direct physical link to laptop, or radio link to laptop) or from a remote location through a modem and land-based phone line (Figure 5.13).

When an animal crosses the road, the event typically results in four records, two on each side of the road that mark the beginning and end of the break-of-the-beam. If the animal crosses the road straight, the detections occur in the zones that are on opposite sides of the road. Based on the

location of the detection zones and the date and time stamp, one can determine the location, direction and timing of the crossing event.



Figure 5.13: Data can be downloaded from the master station at the MT site through a direct connection or a radio link (Photo: Marcel Huijser, WTI-MSU)

5.3.2 Oh DEER, Inc. Animal Detection System (PA site)

Oh DEER, Inc. designed an area-cover system. Area-cover systems detect animals within a certain range of a sensor. The Oh DEER, Inc. system uses transceivers (sensors) that transmit and receive microwave radio signals (10.525 GHz) to detect animal movements (*Edwards and Kelcey 2003; Oh DEER, Inc. 2004*). The system is designed to detect movements of large animals and white-tailed deer in particular. The maximum range of the transceivers is dependent on the settings of the sensor, the size and reflectivity of the target, and whether the animal is in the center or outer edge of the area that they cover.

The sensors covered 805 m (1/2 mi) along Hwy 22/322, in the following road segments: eastbound, 0400/1938 until 0420/0000; and westbound, 0401/2500 until 0421/0000 (Figure 5.14). In total there were 17 stations (poles), each with two sensors (9 along the westbound lanes; 8 along the eastbound lanes). Most stations were about 91 m (300 ft) apart, but some were only about 61 m (200 ft) apart because of the location of the on-ramp for the eastbound traffic (Figure 5.6).

The segments/offsets of the system were as follows: EB Test Area Ahead sign (390/2595), EB Deer Warning Sign (400/0760), 1st EB detector (400/2325), Last EB detector (410/1865), EB End Test Area sign (410/2020). WB Test Area Ahead sign (431/2140), WB Deer Warning sign (421/1460), WB Central Hub (421/2315), 1st WB Detector (421/2465), Last WB Detector (411/2265), WB End Test Area sign (411/2410).

The sensors were attached to 4x4 inches wooden poles, about 1.8 m (6 ft) above the ground. The two sensors faced opposite directions, away from the pole, about parallel to the road. Each sensor covered about 180°, resulting in full coverage (360°) around each station. However, the range of the sensors was highest in the direction they face, at least 46 m (150 ft), and lower towards the outer edges of the 180° degrees that they cover, about 3.0-6.1 m (10-20 ft) in the direction of the road or away from the road at a 90° angle.

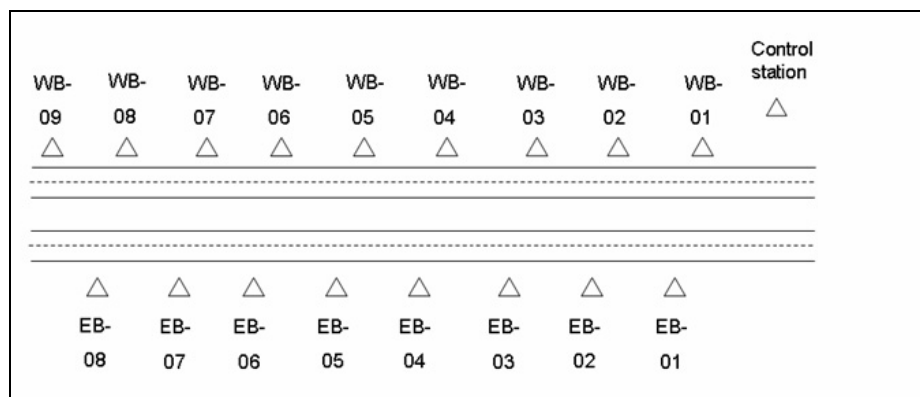

WB= West Bound stations; EB = East bound stations.

Figure 5.14: Schematic layout of the Animal Detection System Hwy 22/322.

The stations were located outside of the clear zone, typically 12.2 m (40 ft) from the edge of the pavement. However, the following poles had different distances to the edge of the pavement: the poles next to the on-ramp for east bound traffic (9.1-10.0 m; 30-33 ft); the poles behind a section with guard rail (6.7 m; 22 ft); and the first two posts in the west bound lane (WB-01 and WB-02) (18.3 m; 60ft).

The wooden posts were set in concrete. The poles with signs were inside the clear zone and had two holes just above the ground as a break-away system. Each station was powered by solar panels that were attached to the same pole. Batteries covered periods of darkness or instances with snow on the solar panels and were recharged by the solar panels (Figures 5.15 and 5.16). The control station was connected to a 110 V power source (Figure 5.17).



Figure 5.15: A station at the PA site. The sensors and battery are located inside the grey box on top of the pole. The solar panel is attached to the side of the pole. (Photo: Marcel Huijser, WTI-MSU)



Figure 5.16: A closer view of the box with sensors, battery and the solar panel (Photo: Marcel Huijser, WTI-MSU)



Figure 5.17: The control cabinet at the PA site (Photo: Marcel Huijser, WTI-MSU)

The stations with the sensors receive a “detection value” 5002 times per second for each of the two sensors (A and B). The stations then count the number of times a detection value meets a certain threshold for each sensor. The threshold depends on local conditions and is different for each sensor. Each station is polled (900 MHz) by the control station (see Figure 5.14) about every 8 sec. If the cumulative count over an 8 sec interval is greater than 2000 the controller station considers it a valid deer detection. This value corresponds to 1-2 sec of sustained deer movement within the detection range of a sensor (Joel Hagen, Oh DEER, Inc./Acumen Instruments Corp., personal communication).

Once the controller station has determined that it is a valid deer detection, a “beacons on” radio signal is sent that activates two alternating flashing amber warning lights, one pair on one location for each travel direction. For eastbound traffic the warning lights were located 425 m (1400 ft) before the first station with sensors. For west bound traffic the warning lights were located about 259 m (850 ft) from the station because of the clear zone for the off-ramp and limited sight distance. The warning lights were accompanied by standard black on yellow deer crossing warning, plus signs that say “USE EXTRA CAUTION WHEN FLASHING” and “NEXT ½ MI” (Figure 5.18). If no new detections occur the warning lights are turned off after three minutes.

Drivers were informed of the presence and function of the system by two black on yellow signs, one for each travel direction, about 800 m (2,630 ft) before the first station with sensors. The signs said “ANIMAL DETECTION TEST AREA AHEAD” (Figure 5.19). In addition, there was another black on yellow sign for each travel direction that said “END TEST AREA” about 45.6 m (150 ft) past the last station (Figure 5.20).



Figure 5.18: Warning signs and signals at the PA site (Photo: Rhonda Stankavich, PENNDOT)



Figure 5.19: Sign announcing the test area at the PA site while still at the maintenance office (Photo: Marcel Huijser/WTI-MSU)



Figure 5.20: Sign marking the end of the test area at the PA site while still at the maintenance office (Photo: Marcel Huijser/WTI-MSU)

The system stored detection data on a flash card. The data included station identification number (e.g., WB-01) and sensor (A or B), detection value, whether the flashing lights were turned on or not, battery voltage, solar panel voltage and temperature in the box with equipment. The last three parameters allowed for identifying potential problems. The data were downloadable on-site or from a remote location through a modem and land-based phone line. The time delay for signal turn off could also be set from a remote location.

5.4 ROLES AND RESPONSIBILITIES

The work for the animal detection systems at the MT and PA sites was divided into different phases: design and planning, installation, operation and maintenance, and evaluation. Multiple organizations and people were involved during these phases. This section summarizes the roles and responsibilities assumed by the project partners for both the MT and PA sites. Contact details are listed in Appendix E. (Note: funding and project administration are discussed in Chapter 1.)

5.4.1 US Hwy 191, Yellowstone National Park, MT

Sensor Technologies and Systems (STS): Designed and delivered an animal detection system. The system had to meet the requirements listed in the contract between the Western Transportation Institute at Montana State University (WTI-MSU) and STS, including the requirements of the Request for Proposals and federal and state regulations. In addition, the design had to meet the requirements of Yellowstone National Park with respect to landscape aesthetics, including the height and size of the poles and equipment. Other activities included problem identification, further research and development, repairs to and modifications of parts of the hardware and software after the installation of the system in October/November 2002 (see Appendix C: Project History).

Michiana Contracting Inc. and their subcontractors Eagle Rock Timber Inc. and Dependable Paint and Drywall Inc.: Assembled, painted and installed the sensors, poles, foundations, cabinets, solar panels, batteries and wiring in October/November 2002 (Figures 5.21-5.24). The work had to meet the requirements and specifications listed in the Request for Proposals, the contract between WTI-MSU and STS, and federal and state regulations. In addition, the work had to meet the requirements of Yellowstone National Park for topsoil and vegetation preservation and paint. After installation, Michiana Contracting Inc. and Eagle Rock Timber Inc. corrected problems with some of the concrete foundations and break-away systems.

3-Rivers Communications: Installed and replaced equipment required to connect the master station of the system to a land-based phone line that runs alongside the road.



Figure 5.21: Michiana Contracting, Inc. assembled the animal detection system at the MDT maintenance yard in Bozeman, MT (Photo: Marcel Huijser, WTI-MSU)



Figure 5.22: Eagle Rock Timber installed the poles and foundations at the MT site (Photo: Marcel Huijser, WTI-MSU)



Figure 5.23: Installation of the antennas, beacons, signs and solar panels at the MT site required the use of a bucket truck (Photo: Marcel Huijser, WTI-MSU)



Figure 5.24: Sensors at the MT site were aligned by using a scope (Photo: Marcel Huijser, WTI-MSU)

Montana Department of Transportation (MDT): Co-hosted the system with Yellowstone National Park. The highway is on national park land but is maintained by MDT through an easement agreement with the National Park. MDT also coordinated the production of the signs; installed the signs that inform and warn drivers; provided traffic control during installation and for major modifications and repairs (Figure 5.25); provided logistical assistance (e.g., storage; workshop); provided manpower, vehicles and tools for certain modifications and repairs; and coordinated the connection of the system to a land-based phone line by 3-Rivers Communications. MDT will assume ownership of the system and responsibility for operation and maintenance once the system meets the requirements listed in the RFP, the contract between WTI-MSU and STS, and federal and state regulations. MDT also paid for the phone service. Finally, MDT recorded animal-vehicle collision data and shares them with Yellowstone National Park.



Figure 5.25: Montana Department of Transportation provided traffic control at the MT site (Photo: Marcel Huijser, WTI-MSU)

Yellowstone National Park: Co-hosted the system with MDT, set requirements for the appearance and dimensions of the system (e.g., paint color, preference for wooden poles where possible), set requirements regarding topsoil and vegetation preservation, and issued a research permit to WTI-MSU. Yellowstone National Park also recorded and provided animal-vehicle collision data.

Western Transportation Institute at Montana State University (WTI-MSU): Coordinated all phases of the project and communication between project partners. WTI-MSU also prepared the signing plan, contracts and other project related documents (including monthly reports, draft management plan), helped with problem identification and formulating strategies to correct problems. WTI-MSU was also responsible for the evaluation of the reliability and effectiveness of the animal detection system, gave advice to FHWA, individual DOT's, and other organizations with regard to the application of animal detection systems, and delivering the final report. Other activities included presentations at regional, national and international conferences and giving interviews to the media (Appendix F).

5.4.2 Hwy 22/322, near Thompsontown, PA

Oh DEER, Inc.: Designed and delivered an animal detection system. The system had to meet the requirements listed in the contract between WTI-MSU and Oh DEER, Inc., including the requirements of the RFP and federal and state regulations. Other activities included repairs to and modifications of parts of the hardware and software after the installation of the system in May 2004 (Appendix C).

Signal Service Inc.: Produced and delivered the flashing amber warning light units.

Sprint: Provided a land-based phone line connection for the control station.

PPL Corporation: Provided an electricity connection (110 V) for the control station.

Edwards and Kelcey, Inc.: Produced the engineering plan (including the signage plan), and "as-built" documentation based on the information provided by Oh DEER, Inc. Edwards and Kelcey was instructed by PennDOT.

Pennsylvania Department of Transportation (PennDOT): Hosted the system; installed foundations and posts; provided traffic control during post installation; cleared bushes, branches and other vegetation (Figures 5.26 and 5.27); contracted and coordinated the engineering plans, signing plan and "as-builts" with Edwards and Kelcey; coordinated sign manufacturing and delivery; installed the signs; coordinated the installation of 110 V power and a land-based phone line for the control station; and coordinated system installation with Oh DEER, Inc. PennDOT will assume ownership of the system and responsibility for operation and maintenance once the system meets the requirements listed in the RFP, the contract between WTI-MSU and Oh DEER, Inc., and federal and state regulations. PennDOT also paid for the electricity and phone service and coordinated contacts with the media. PennDOT also collected road kill monitoring data.



Figure 5.26: The wooden poles were fitted with a concrete foundation at the PA site (Photo: Marcel Huijser, WTI-MSU)



Figure 5.27: Before installation the high shrubs and weeds were cut and branches of trees were removed at the PA site. (Photo: Marcel Huijser, WTI-MSU)

Western Transportation Institute at Montana State University (WTI-MSU): Helped coordinate the different phases of the project and the communication between PennDOT, Edwards and Kelcey and Oh DEER, Inc. WTI-MSU advised on various design aspects (including sign plan) and system installation. WTI-MSU also prepared contracts and other project related documents (including monthly reports). WTI-MSU was also responsible for the evaluation of the reliability and effectiveness of the animal detection system, gave advice to FHWA, individual DOT's, and

other organizations with regard to the application of animal detection systems, and delivering the final report. Other activities included presentations at regional, national and international conferences and giving interviews to the media (Appendix F).

6.0 POST INSTALLATION MODIFICATIONS TO THE ANIMAL DETECTION SYSTEM IN MONTANA

Authors: Lloyd Salsman & Terry Wilson
Sensor Technologies & Systems, Inc.
8900 East Chaparral Road, Scottsdale, Arizona 85250 (e-mail: terry_wilson@sensor-tech.com)

6.1 INTRODUCTION

RADS (Roadway Animal Detection System) is a millimeter wave, beam-break technology that detects large animals that approach or leave a road section equipped with the system (see also Chapter 5). The system activates a traffic warning beacon to warn drivers of an animal on or near the roadway.

A prototype of the RADS system was installed between reference posts 28-29 of US Hwy 191 in Montana (inside Yellowstone National Park) in October/November 2002. After the initial installation, a number of problems were uncovered with the system. RADS did not become operational until November 2004. RADS performance was continuously monitored and evaluated between 2002 and 2005. This chapter provides an overview of the technical challenges encountered and how these problems were addressed.

6.2 SYSTEM DESCRIPTION

6.2.1 Beam break technology

RADS is comprised of an arrangement of beams located on both sides of a highway segment. The beams establish a protected corridor. A beam is formed by a transmitter and a receiver pair. The transmitters are a source of electromagnetic radiation, much like a flashlight. The receivers are detectors, much like the human eye, that observe the intensity of the signal from the transmitter.

An animal crossing the beam is indicated by a characteristic decrease in millimeter wave radiation arriving at a receiver station. This characteristic reduction in signal at the receiver station is a “beam break” event.

Transmitters and receivers are located at stations comprised of support poles, signage, traffic beacons, beam tubes, solar-powered batteries with battery compartments, and RADS electronics. The local highway topology determines the number and location of the RADS stations.

The master station polls the array of receiver stations on a 1.5 second cycle for a beam break event. A change in the array beam break conditions results in a log entry at the master station. A beam break event also triggers the activation of the traffic warning beacons.

6.2.2 System lay-out

Figure 6.1 shows the RADS layout (December 2005) between reference posts 28 and 29 on US Hwy 191. Significant features in the one-mile long road section are a parking lot, a trailhead, the Black Butte Ranch access road, and a turnout. The master station (station 4) is located on the east side of the highway approximately in the middle of the array (see Figure 5.7), between detection Zone 0 and 1). A rocky slope of Black Butte, is located to the south of the master station. The rocky slope prevents a direct, line-of-sight signal path between two stations at the south end and the master station, challenging UHF radio signals between these two stations and the master station. The parking lot entrance across from the Black Butte Trailhead is excluded from RADS operation, but the Black Butte Ranch access road, part of the turn-out, and the Black Butte trailhead are included in the protected corridor.

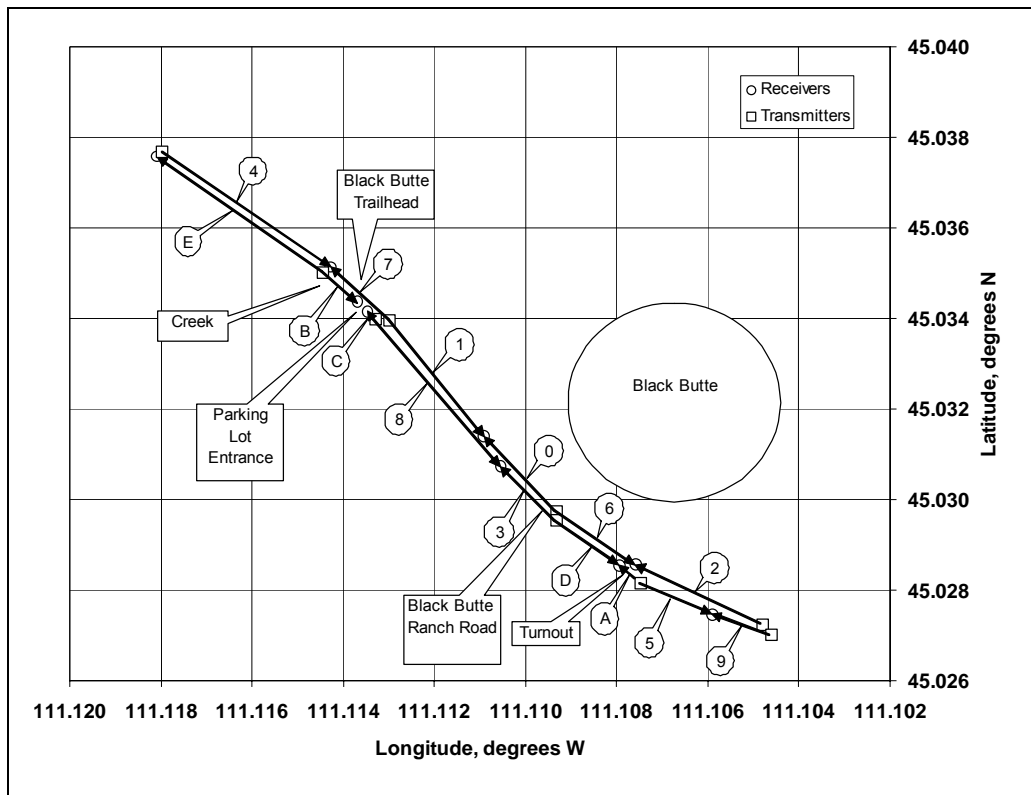

Figure 6.1: RADS layout showing station locations, receivers, transmitters, and codes for the detection zones

6.2.3 Transmitter/receiver stations

RADS is composed of three station types: transmitter, receiver, and master. An optional traffic warning beacon can be installed on any station type. Figure 6.2 shows a typical station with

mounted beam tubes. The RADS Montana site consists of one master station, nine transmitter stations, and eight receiver stations (see also Chapter 5, Figure 5.7).



Figure 6.2: Typical receiver/transmitter station showing beam tubes and mounts at an Indiana site (see Chapter 4 for details on the Indiana site) (Photo: Lloyd N. Salsman, STS)

6.2.3.1 Transmitter station

A transmitter station generates one or two beams; in the case of two beams, they point in opposite directions. A transmitter produces an amplitude-modulated, millimeter wave signal focused by a lens system on a receiver module located downrange. The transmitter module is attached to the station by a bracket, which allows the beam to be positioned in height (above ground), azimuth angle, and elevation angle. The current transmitter module (December 2005) produces a 3° beam-width. A transmitter is capable of producing a detectable signal up to 0.25 mi (402 m) when combined with the receiver module.

A traffic warning beacon can be added to a transmitter station. Typically, this configuration would occur only just before or at the entrance or exit of the array, or at certain intervals along the protected corridor. A beacon requires a directional antenna, a data radio, a signal processor, a power relay, and a beacon light in addition to the standard transmitter hardware complement.

6.2.3.2 Receiver station

A receiver station supports the detection of one or two beams; in the case of two beams, they are oppositely directed. The receiver module focuses millimeter wave radiation from the transmitter on a crystal detector. The detected signal is amplified and band-limited.

The amplified signal is examined by a digital signal processor to select the particular amplitude modulation frequency associated with the assigned beam, to estimate the baseline signal and noise levels, to compute an adaptive threshold, to determine a beam break condition, and to communicate with the master station. The current receiver module (December 2005) produces a 3° beam-width. The sensitivity of the detection process allows operation of a transmitter/receiver pair up to 0.25 mi (402 m).

Each receiver station is equipped with a data radio and a directional antenna. The antenna is directed toward the master station position. Radio communications only occur between a receiver station and the master station.

A traffic warning beacon can be added to a receiver station. A power relay and beacon are required in addition to the standard receiver station hardware complement for beacon operation.

6.2.3.3 Master receiver station

RADS requires a single master receiver station. The master station consists of a standard receiver station with the addition of a microcontroller (the MTC). The MTC incorporates a logging memory, a data radio, and a real-time clock. Provisions for interfacing a telephone or satellite modem are also included.

The master station uses an omni-directional antenna to send and receive information to the radio network formed by the receiver (and beacon-equipped transmitter) stations.

6.2.4 Beam assignments at the MT site

Beam breaks are reported by “beam number” (i.e., “beam numbers” are equivalent to detection zones). There are 16 possible beam numbers; 15 are used at the MT site (see Figure 5.7 and Figure 6.1). Each beam between a transmitter and a receiver pair has a unique number. An animal that crosses the road would trigger the beams on opposite sides of the road, (e.g., [4, E], [B, 7], [C, 1], [8, 1], [3, 0], [D, 6], [A, 6], [5, 2], and [9, 2]). Conversely, a road crossing can be detected by observing “pairs” of closely spaced (in time) beam breaks in the RADS log.

6.2.5 Detection process

The detection process is the most critical feature of the system. Changes in the received beam intensities must be evaluated to separate interference signals from real animal detections. The following paragraphs describe the detection process implemented in the current RADS (December 2005).

The digital signal processor uses frequency selective filters to eliminate interfering signals from adjacent beams. The selected signal is compared to signal thresholds which have been computed from previously processed signals. The baseline signal level and the noise level are estimated by the signal processor. The baseline signal level and the noise level estimate are combined to produce an upper and a lower threshold.

A beam break condition is declared if the input signal falls below the lower threshold for a period of time longer than the “short” time delay (see below). The beam break condition is removed when the input signal rises above the upper threshold. The “short” time delay eliminates low flying birds from the RADS response. If the beam is interrupted for more than 10 seconds (the “long” time delay), the baseline estimate is reset to the current input signal level. If the lower threshold falls below a minimum value, the detection process is stopped until the signal recovers. This action eliminates spurious beam breaks by objects stationary in the beam (e.g., cars parked in the turnout).

6.3 RADS ANALYSIS AND REMEDIATION

The initial installation of RADS in Montana exhibited a range of improper operations. The problems and remediation were studied both in the field (at the Montana site and at the Indiana site (see Chapter 4)) and in test facilities in Scottsdale, AZ, USA. The latter location also had a RADS system for observation and performance evaluation.

System level problems were identified by studying data logs and observations from field visits. An examination of the RADS at a system level was performed to determine if the original system specifications were representative of field operation. These specifications included the necessary dynamic range to provide some degree of interference rejection and the adaptability/sensitivity of the detection process to variations in signal level. Component-level evaluation was performed to determine whether RADS components were failing to achieve their intended performance level.

Site visits were conducted at both the Montana site and the Indiana site to determine if the systems in the field exhibited the same behavior as observed on the Scottsdale test system. During these field visits, data were collected, analyzed, and compared to RADS performance models used in the development of RADS specifications.

The following sections describe the deficiencies observed in the original RADS, the testing involved in isolating and identifying failures, and the actions taken to correct RADS operation in the field.

6.3.1 RADS deficiencies

6.3.1.1 Multiple false alarms

After the system was installed and initial gain settings were made, expected operation was obtained for a short time. As the system aged, large numbers of beam breaks were reported. The high number of beam breaks suggested that many of them may have been false detections rather than detections caused by large animals.

6.3.1.2 Detection thresholds

The detection thresholds, used for identifying a beam break condition, were fixed in the original system. These thresholds were sensitive to the input signal levels determined by the installed video gain and could vary among installed receivers. Since these thresholds

were fixed in the system, RADS could not adapt to changes in the environment (e.g., vegetation encroachment, temperature) which could result in erroneous beam breaks.

6.3.1.3 *Vegetation interference*

Several beams were overcome by vegetation in the beam path. Some vegetation removal was allowed by Yellowstone National Park to alleviate this problem. Figure 6.3 shows a vegetation removal operation in the beam path in August 2004.



Figure 6.3: Randy Moore mows vegetation in front of one of the sensors to evaluate the effect of high, moving, broad-leafed, and wet vegetation on the occurrence of false positives (Photo: Lloyd N. Salsman/STS)

6.3.1.4 *Remote command and telemetry*

The original RADS system was designed to use a cell phone for remote control and downloading of the detection data. However, the cell phone service at the site proved to be insufficient. Therefore the system was connected to a telephone land-line that ran along the US Hwy 191. Initially, this land-line proved to be noisy and subject to failure. Reliable contact with the Montana RADS could not be established using the original software, processor, and modem package.

6.3.1.5 *Local command and telemetry*

Software problems with the local interface made control and observation of RADS impossible even at the site. This shortcoming made testing and verification of system operation difficult since the real-time, system operating details were not visible to the engineering personnel.

6.3.1.6 *RF interference at the detector*

The wideband crystal detector was subject to interference by local RF sources (e.g., cell phones and commercial radios). The cell phone interference was noted in Montana by holding a cell phone in proximity to the RADS equipment. Even though there is no cell

phone service, the cell phone attempts to contact the cell base site by periodically transmitting autonomously. The active RF transmission causes the interference. In addition, commercial radios used by highway maintenance personnel caused additional interference.

6.3.1.7 *Beam crosstalk*

Some beam misalignment (sometimes as a result of a beam tube mount failure) caused signals from other beams to be incorrectly received. The signal processor was unable to accommodate the increased signal levels and was not able to differentiate the interfering beam from the correct beam.

6.3.1.8 *Radio link not reliable*

The original data radio was not reliable. A commercial data radio was retrofitted to the master station and receiver stations. The new radio incorporated error-retry functions which greatly improved the data link reliability under all conditions.

6.3.2 RADS component evaluation

Given the field performance of the RADS in Montana, a review of the components and system performance was conducted. Test fixtures were constructed in Scottsdale to evaluate component level performance. A trial system was installed on the Pima reservation near Scottsdale for signal level studies. Furthermore, new software was installed to provide telemetry access to critical system variables.

The component evaluation showed that the transmitter and receiver modules were working as intended; however, the digital detector was not working correctly.

6.3.2.1 *Transmitter frequency stability*

The transmitter including the modulator was studied to determine the degree of frequency “pulling” that resulted from temperature changes. A spectrum analyzer with a down-converter was used to observe the modulated beam as the gunn-diode was alternately cooled and heated. The transmitter proved to be remarkably stable. As a result of these tests, it was determined that the original transmitter design met RADS requirements.

6.3.2.2 *Transmitter beam characteristics*

The transmitter beam width and symmetry were studied using an azimuth table and a receiver consisting of a spectrum analyzer and a down-converter. The mechanical centering versus the microwave centering of the beam was of concern. Testing was conducted to insure that the beam was collimated. The beam width and centering of the original beam tube were found to meet RADS requirements.

6.3.2.3 Receiver sensitivity

The receiver sensitivity was studied by constructing a sweeping frequency source that could be observed by the unit under test. The sensitivity variation versus frequency was determined by this test (see Figure 6.4). The top trace shows the change in test frequency. The bottom trace shows the crystal detector output. The crystal detector was shown to be relatively insensitive (a good feature) to frequency changes.

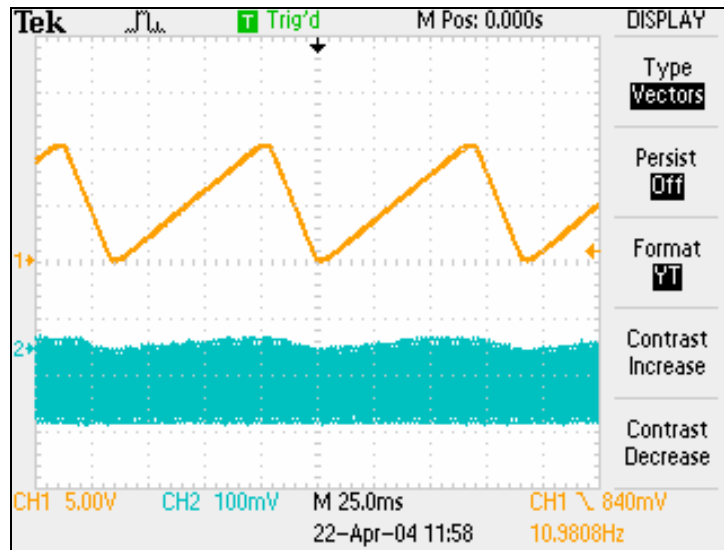

Figure 6.4: Detector output under frequency sweep showing nearly constant sensitivity (bottom) versus frequency (top).

A set of absorber pads was calibrated using the spectrum analyzer, the down-converter, and sweeping signal source. The absorber pads were inserted in combinations to determine the dynamic range and sensitivity of the detector module. Adequate dynamic range is critical to the overall system performance.

Several different diode types have been used in the detector. The diodes exhibited a range of sensitivities. As a result of these tests, the detectors were classified by sensitivity. Lower sensitivity detectors are installed in shorter beam length installations where the reduced sensitivity is not a factor.

6.3.2.4 Receiver beam characteristics

The receiver beam width and symmetry were studied using an azimuth table and the sweeping signal source. Collimation of the beam is a requirement of the RADS beam tube assembly. As a result of these tests it was determined that the original receiver module met RADS requirements.

6.3.2.5 Modulation characteristics

The modulation frequencies for the original system were selected using a “factoring process” to eliminate harmonic interference among the beams. The “factoring process” was demonstrated to be a flawed concept. New modulation frequencies were selected that fall within one octave (2:1 frequency range). Sixteen channels were assigned in such a way that at least 40dB of attenuation was provided between adjacent channels. This selection reduces the interference from adjacent beams in the selected beam. Digital selection filters based on this design specification were designed and tested. Figure 6.5 shows the frequency assignments and the channel selection filter requirements. Each beam (or detection zone) is associated with a particular channel (modulation) frequency.

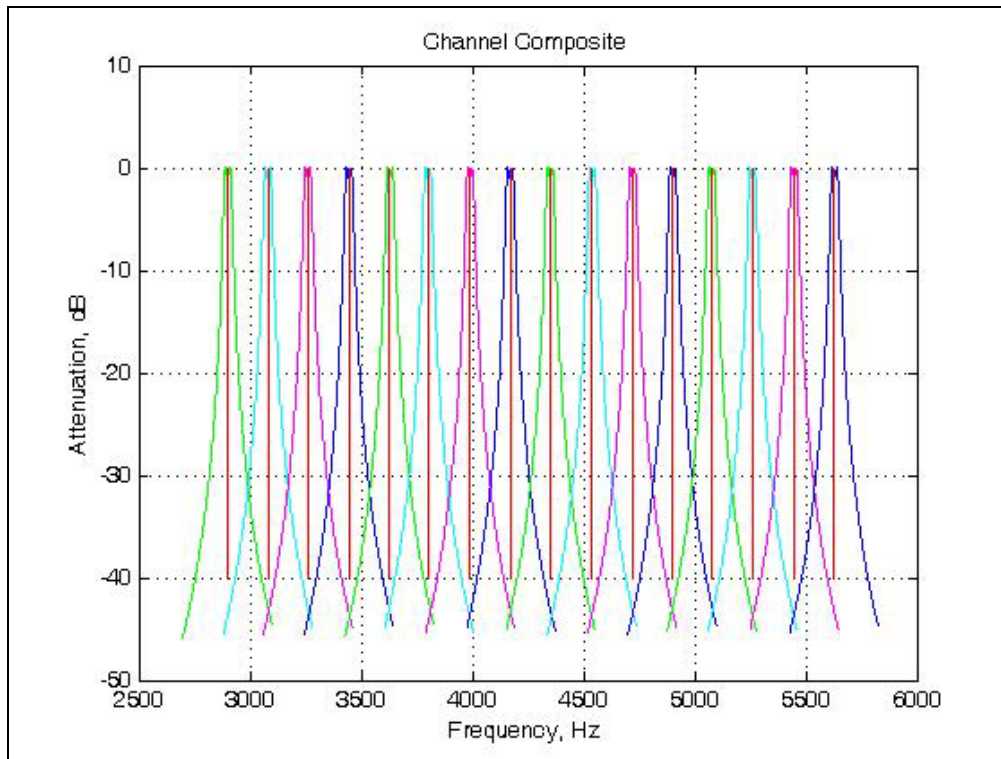

Figure 6.5: Center modulation for each of the 16 RADS Channels. The center modulation is used to distinguish between the individual detection beams (channels).

6.3.2.6 Digital detector

The original digital detector was tested and found to cover a dynamic range that was too small to accommodate field conditions. A new detector was developed and tested using the Pima test facility.

6.3.2.7 *Crystal detector and video amplifier characteristics*

The crystal detector and video amplifier were checked using a temperature chamber to determine the temperature sensitivity of the signal chain. The temperature-dependent crystal sensitivity was not compensated in the original design. Adjustable video gain and temperature compensation were added as a result of this study.

6.3.3 **Cross section studies**

The system was triggered using various targets, including humans, horses, and birds. The target signatures (receiver levels) were investigated. The results of this study were used to minimize detections not caused by large animals. The effect of road traffic on the signal was investigated by moving the system parallel to Pima Road near Scottsdale. Rotating the polarization of the beams was also studied. Figure 6.6 shows the test site used to evaluate traffic interference. The polarization of the receiver and transmitter beams was changed to minimize reflections from passing vehicles.



Figure 6.6: Pima Road test site, Scottsdale (Photo: Lloyd N. Salsman, STS)

A bird simulator was constructed using a bottle of water and a rope. This simulator was used to determine the probability of detecting a bird at different distances and speeds.

6.3.4 Link attenuation model verification

The attenuation model for RADS was examined using data taken in the field. This model was used to estimate the maximum detection distance for the beams and to estimate the interference levels that could be handled by the detection processor. The attenuation model appeared to correctly represent the path loss process.

6.3.5 Detector model verification

The detector model for RADS was examined using data taken in the field. The detector model was found to incorrectly predict the detection level. The detector was modified to match the test data. A change in the dynamic range and sensitivity specification was made as a result of this study.

6.3.6 Telemetry of critical data

In the original system, critical internal variables (e.g., detector output and video output) were not accessible. Programming changes were made in the digital signal processor to support telemetry of some internal variables in real time. Since the serial port for the digital signal processor is not directly available when the unit is installed in a RADS station, a special (mimic) procedure was developed to allow a second processor to be installed externally while being monitored by a computer. This technique allowed field observation of RADS performance. From this information, improved detector algorithms were developed. Another byproduct of the detector data analysis was an illustration of the vegetation effects of and the effectiveness of methods for vegetation removal.

Figure 6.7 shows a data recording taken from the receiver at station 18 (see Figure 5.7) during a test with a horse at the site along US Hwy 191 in Yellowstone National Park (see also Figure 6.10). The raw detector output is shown in solid black (Ch1 Detector). Negative going pulses are possible “beam break” events. The baseline estimate (dotted line) is used as the basis for the adaptive threshold computation. The noise estimate is shown as a broken line. The baseline estimate and the noise level estimate are combined to produce an upper and a lower threshold based on signal history. The computed upper and lower threshold for the current baseline and noise estimate are shown on the plot.

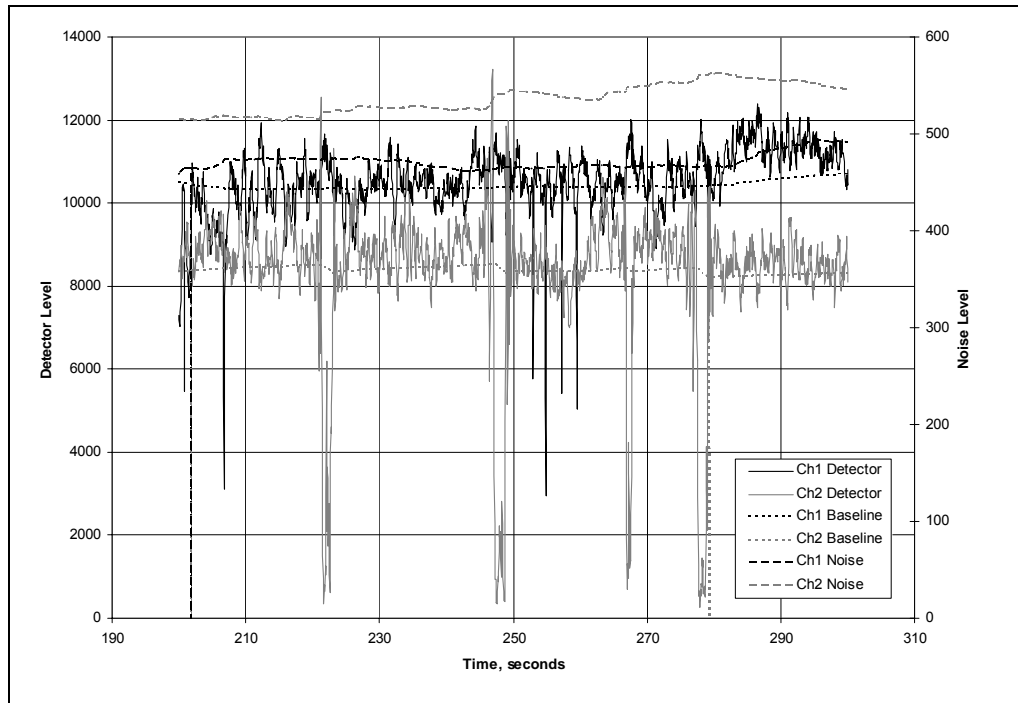

Figure 6.7: Detector recordings from the horse test at the site along US Hwy 191 in Yellowstone National Park, ST18.

6.3.7 RADS evaluation

6.3.7.1 *Dynamic range*

Testing revealed that the original system dynamic range, including the digital detection processing, was too small for effective operation in the field environment.

6.3.7.2 *Data link*

The original radio link proved not optimized for data transport. The spread spectrum radios, currently in use (December 2005), have error handling protocols to improve the reliability of the data connection. The remaining data link problem is the location of the receiver stations. In Montana, two stations do not have a line-of-sight signal path to the master station due to a rocky slope, which increases the probability for error in transmissions.

6.3.7.3 *Master station complexity*

The original master station incorporated a PC104 modular computer. The master station software was very complex and could not be thoroughly tested without having a RADS array available for testing. It was decided that the remote location of the site in Montana required a simpler and more reliable processor.

6.3.7.4 Transmitter and receiver stations

Testing revealed that the millimeter wave transmitters and receivers met the intended specifications for RADS. However, RF interference modifications were not included in all receivers. Receivers were examined and brought up to the current design level in the field.

6.3.7.5 Beam height and location

Tests conducted by WTI-MSU (see Chapter 7) revealed “blind spots” in the beam coverage. The longest blind spot occurred along most of beam 8 (see Figure 5.7). A six-foot tall human can walk under the beam without breaking it for about 2/3 of the beam length from the north to the south extent of the beam. Moving the RADS stations may be necessary to resolve the blind spot in beam 8.

In the Indiana installation, one beam (beam 3 in mile 141) was located over a guardrail. Multipath from long vehicles (trucks with one or more trailers) caused detections to be declared in this beam. The beam output was observed and a special detection algorithm (software) was developed to treat this particular installation.

6.3.7.6 Modulation frequencies

The original modulation frequencies were developed under a flawed theory to eliminate harmonic interference. New modulation frequencies were selected to minimize interference and crosstalk.

6.3.7.7 Mounting brackets

The mounting brackets used to secure the beam tubes to the station poles are susceptible to fracture (Figure 6.8). The elevation pivot consists of clamp surrounding a pin. The cast aluminum appears to fracture under thermal stress. Thus far, the manufacturer of the brackets (Pelco of Edmund, OK) has not responded to inquiries regarding this product.



Figure 6.8: The brackets holding the sensors cracked as a result of extreme temperature fluctuations at the MT site
(Photo: Marcel Huijser, WTI-MSU)

6.3.7.8 Radomes

Radomes (shields) were added to the transmitter and receiver stations to prevent the accumulation of snow and ice in the beam tube aperture (Figure 6.9 and Figure 6.10). Accumulation of wet snow can reduce the signal level of the beam, resulting in loss of dynamic range.



Figure 6.9: Snow and ice build-up on the sensors caused false positives at the MT site (Photo: Marcel Huijser, WTI-MSU)



Figure 6.10: Placing a smooth surface at an angle in front of the sensors prevented snow and ice build-up on the sensors at the MT site (Photo: Marcel Huijser, WTI-MSU)

6.3.8 RADS testing

6.3.8.1 Laboratory testing

A component test for the RADS transmitter and receiver was conducted on a test range at the STS facility in Scottsdale, AZ (see earlier). The tests included the electrical characterization of the millimeter wave components to determine if the intended specifications were met.

6.3.8.2 Field testing

A temporary installation of a RADS beam was constructed on the Pima reservation north of the STS facility in Scottsdale, AZ. Testing at this facility included evaluation of automobile traffic on the beam at various locations and polarizations. Recordings of the detector outputs were made using various targets including humans, horses, and birds.

Test programs for the radio data link were modified and expanded for use in the field installations in Montana and Indiana.

6.3.8.3 Montana site testing

During the Montana site visit in May 2004, recordings of the beam responses were made. Local operation of the master station was attempted. A complete survey of the installation was conducted including oscilloscope recordings of waveforms from each station. The receiver detection software was changed to the new modulation frequency assignments. Although this site visit was not the first visit to the site, it is referred to as the “first visit” for the purpose of this chapter.

A second visit to the Montana site was conducted during August, 2004. The software for the receiver digital signal processor was modified to incorporate a new adaptive detector algorithm. The beams were triggered using a human as a model for wildlife (Figure 6.11, Figure 6.12). A portable master station was used to operate the RADS installation. The master station software failed to function.



Figure 6.11: Randy Moore (STS) triggers the system at the MT site (Photo: Marcel Huijser, WTI-MSU)



Figure 6.12: Lloyd Salsman (STS) investigating signal signatures at one of the stations at the MT site (Photo: Marcel Huijser, WTI-MSU)

A third visit to the Montana site during November, 2004 was for the purpose of replacing the master station computer. The master station was replaced by the MTC. The system functioned into December, 2004 when a recording failure stopped the system operation.

A fourth visit took place in December 2004. The system was restarted and data from November and December were collected and analyzed.

Two software updates were made using emailed code from STS to WTI-MSU. WTI-MSU applied the software updates in the field. The new software corrected errors in computing the length of the Multi Media Card (MMC) buffers for the data logger.

A fifth visit was conducted in May, 2005 for the purpose of examining the erratic operation of beam 1. Software for the MTC was updated again to correct an error in the compiler, which prevented the proper storage and recovery of internal registers.

A sixth visit took place in June 2005. At this time, the modem for the land-based phone line was installed and remote operation was tested.

6.3.8.4 Horse test

During the August 2004 visit a comprehensive test of the detection algorithm was conducted using a horse and rider (see Figure 6.13). The horse and rider were filmed while recording detector outputs under different conditions of speed and aspect.



Figure 6.13: Tests with Ranger Gafney and her horse Buster, Yellowstone National Park, Montana (Photo: Lloyd N. Salsman, STS)

6.3.8.5 Indiana site testing

The first visit to the Indiana site was made to survey the mile 6 (mile 141) system. The system was updated to use the new modulation frequencies and the detection software. Recordings were made of the poor performance of beam 3 in mile 141. Vegetation effects were noted and recordings made for later analysis.

The second Indiana visit was conducted during July 2004. During this visit, the remaining hardware was installed for all miles except mile 130 and 132. The batteries were completely serviced for the entire system. The system was tested using a mobile polling station performing the master station function.

The third Indiana visit was conducted during October 2004. During this visit all six miles were brought online. The master stations were replaced with the MTC. Several beams were realigned based on telemetry data obtained during overnight operation.

6.3.8.6 *Beam-Break Signature*

During testing of the RADS, an unexpected result was observed in the detector output. Dielectric objects moving through the beam produce a signature that is distinct from a conducting object moving through the beam. The inference is that it should be possible to discriminate between animals and vehicles crossing the beam. This phenomenon is being examined for field use in subsequent designs. Figure 6.14 shows an amplitude plot including an “animal” crossing at the right side of the plot.

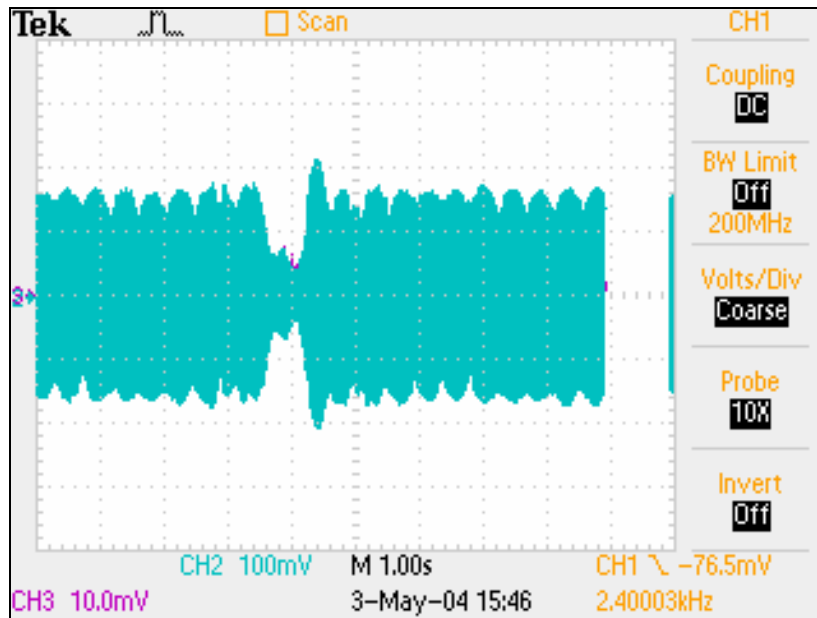

Figure 6.14: Beam break signature for an animal crossing

6.3.8.7 *Vegetation interference*

Vegetation interference was investigated at the sites in Indiana and Montana. The Indiana test site had uniform grassland vegetation up to two feet in height. The Montana test site had patches of clover and brush which obscured the transmitter and receiver beams.

The Indiana site was monitored for half hour intervals to obtain a noise background associated with wind motion induced in the grass. A six-foot wide mower was used to mow a swath between some of the stations to evaluate the noise reduction by mowing different amounts of the affected path. In Montana, permission was obtained to selectively mow vegetation along the roadway. Several tests were conducted by recording the noise estimate while mowing selected sections of the beam path.

We found that removing vegetation in the immediate vicinity of the beam tubes was most effective in lowering the noise. Complete clearing of the beam path was normally not necessary.

6.3.9 Siting problems

Two extreme locations were studied to determine the installation rules for the RADS beams. The results of these studies provided insight into the requirements for locating the beams properly to minimize interference from traffic, vegetation, and highway appurtenances.

6.3.9.1 *Guardrail location*

At the Indiana site, beam 3 on mile 141, I-80/90 was situated over a guardrail. This beam illustrated erratic behavior until detector recordings were made and correlated with the movement of large trucks pulling trailers. These vehicles resulted in beam “pumping” that eventually upset the detector. A special detector algorithm was selected to stabilize this beam. This correction demonstrated the adaptability displayed by a software intensive detection system.

6.3.9.2 *Ideal location*

In Indiana, beam 6 mile 141 on I-80/90 was directly opposite from the guardrail beam (beam 3). In contrast to beam 3, beam 6 had extremely low noise. This near perfect operation illustrated the limit to which the adaptive detector algorithm could be used. A minimum noise limit was imposed to prevent erratic operation on “clean” beams. These two beams illustrated the best (see Figure 6.15) and the worst (see Figure 6.16) behavior of RADS.

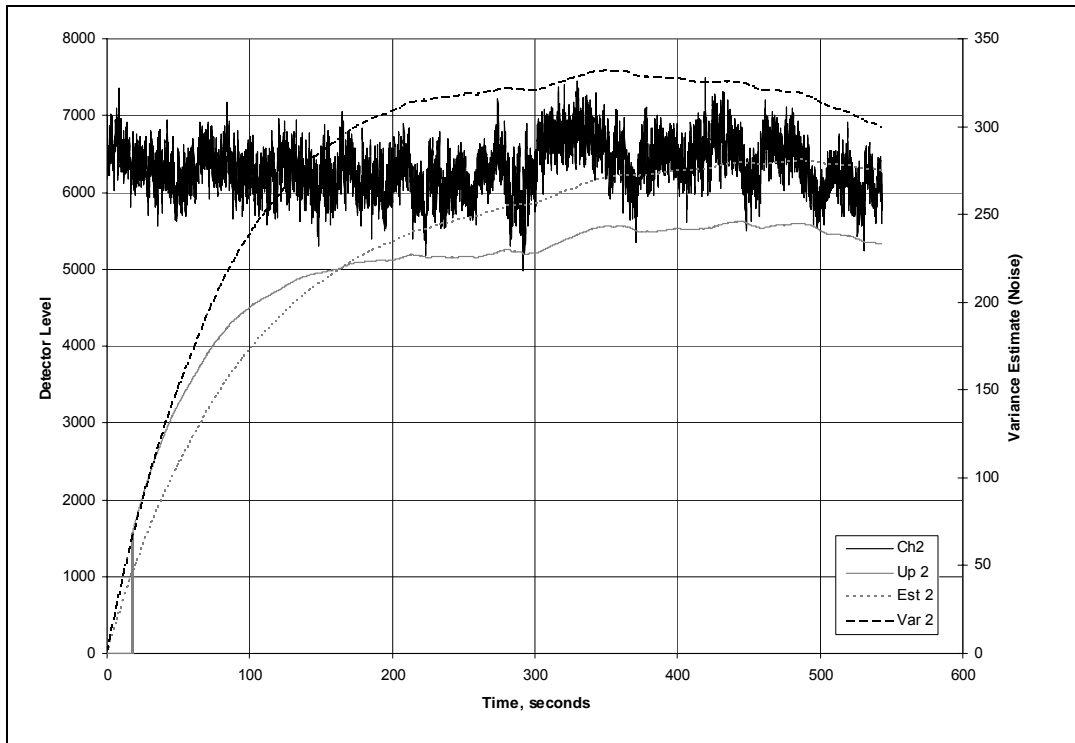

Figure 6.15: RADS “good performance” in a clear path with little vegetation interference. ST12 (3/6) – 20 June 2004, detector - Ch2

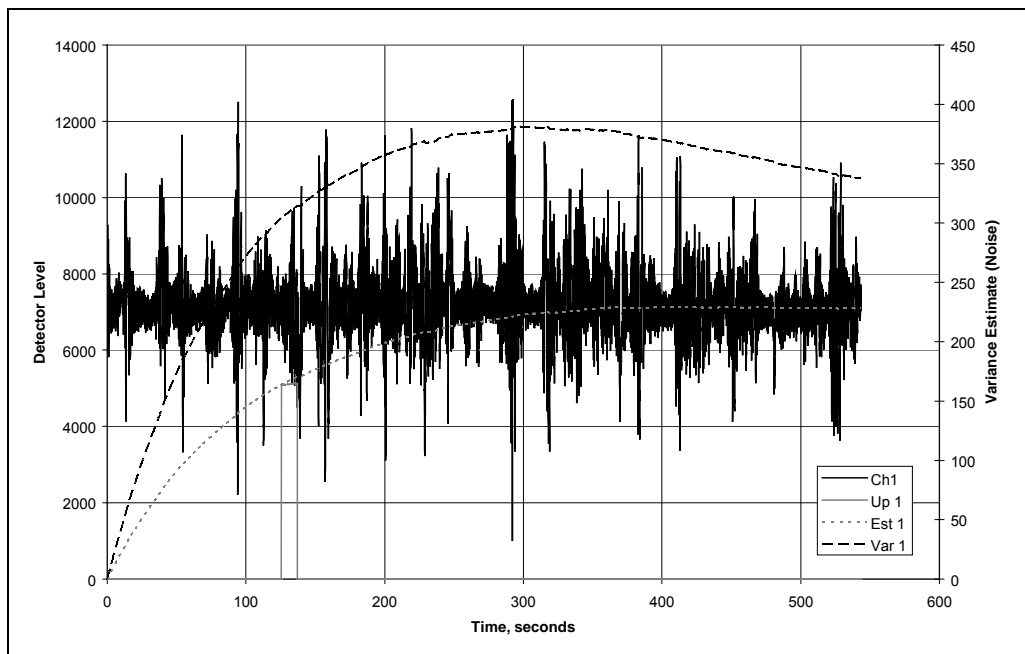

Figure 6.16: RADS “bad performance” for a beam located over a guardrail showing vehicle multipath interference. ST12 (3/6) – 20 June 2004 Detector - Ch1

6.3.10 RADS modifications

6.3.10.1 Replacement of data radio

The data radio was replaced with a commercial unit. This unit included its own data recovery procedures. The master RADS station uses statistics collected by the data radio to evaluate data link performance. These reports were used to evaluate the current design.

6.3.10.2 Adjustment of video amplifiers

The video amplifiers which process signals from the crystal detector were modified to provide manual gain adjustment so that path losses for individual installations could be accommodated. The overall video amplifier gain was compensated for temperature to more closely match the crystal detector sensitivity characteristic.

6.3.10.3 RFI modifications to crystal detector

Additional power supply filtering was added to the crystal detector bias to reduce the effect of local RF sources on the detector output.

6.3.10.4 Beam alignment

The beam alignment was checked using a telescope for each beam in the RADS installation. Misaligned beams were adjusted. Frequency domain measurements were made on the receiver outputs to determine the interference level of adjacent beams.

6.3.10.5 Beam tube mount repair

The beam tube mounts were fractured in several cases apparently as a result of thermal cycling. Several different repair techniques were tested. The most successful technique involved the placement of two stainless steel spring pins in the rotating joint spanning the fracture.

6.3.10.6 Replacement of detector software

The detector software in the signal processor was replaced. The frequency selective filters were changed to match the new modulation frequencies and to meet the adjacent channel interference levels. In addition, an adaptive threshold detector was installed and tested in the digital signal processor.

6.3.10.7 Replacement of master station processor

The master station processor (a PC104) was replaced with an industrial grade microcontroller. The replacement unit was more robust and simpler to manage in the field.

6.3.10.8 Replacement of master station software

The master station software was completely replaced to provide local control and telemetry functions to facilitate testing and evaluation of RADS. Data logging functions and remote access functions were added to complete the RADS installation.

6.3.10.9 Addition of snow shields (radomes)

Snow shields were added to minimize the accumulation of wet snow in the beam tube aperture. Snow accumulation can attenuate the signal, resulting in the loss of dynamic range.

6.4 SECOND GENERATION RADS CHANGES

Based on information gained during RADS studies, a new set of requirements was developed for a future (2nd Generation) RADS. These requirements have been translated into a set of specifications. From these specifications, projections of expected system performance for a 2nd Generation RADS can be made. Some of these projections are outlined in the following paragraphs.

The expected reduction in “footprint” is the most significant feature of the 2nd Generation system. “Footprint” in this discussion refers to the equipment visibility and the amount of space required for the installation of the system.

6.4.1 “On event” service

The current RADS continuously polls the receiver stations to determine the real time status of each receiver. If the master station strategy was changed so that a receiver station contacts the master station when a significant event occurs, the power consumed by the radios (in all stations) can be reduced. The “sleeping” mode for the radio uses only low microwatts of power. The radio can be awakened by data arrival over the serial interface or by the reception of an RF “wake-up” message from a remote radio.

When a “beam break” occurs, the receiver station sends a message to the master station. The master station is tuned to receive a block of receiver addresses. The master station decodes the message to determine the origin address of the calling radio. The master station tunes to the address of the calling radio so that other radios are not disturbed. The acknowledgement message is sent to the calling radio so that the event can be cancelled at the receiver station. The master station resets to receiving the block of receiver addresses to wait for the next event.

Conditions which correspond to an “event” at the receiver station would include a beam break, a beam “restore,” a threshold level below operating levels (indicating that the beam is out-of-service), and power out-of-tolerance. The master station could poll the receiver stations to determine operating status as an additional check on system operation.

6.4.2 Commercial antennas

A commercial millimeter wave antenna is available. This unit has a smaller footprint compared to the original RADS modules. The antenna includes a precision mounting bracket designed for outdoor use in environmental extremes.

The antenna package has provisions for mounting an electronics package directly to the back of the antenna module. This would allow a reduction in the battery compartment space used by the current system. With the expected power reduction, it may be possible to minimize the battery compartment for the solar power supply.

6.4.3 Reduced transmitter duty cycle

Since the crystal detector is a “peak-reading” device, the wave shape of the transmitted waveform can be modified to reduce the power consumption at the transmitter. Experiments have shown that the duty cycle for the transmitter can be significantly reduced while maintaining a detectable wave shape at the receiver.

6.4.4 Reduced power consumption

By changing the radio protocol and reducing the transmitter duty cycle, considerable reductions in power consumed by RADS is expected. The estimated power requirement approaches 10% of the current requirement. Given the substantially reduced power requirement, the solar power system can be downsized, thus reducing costs and the system footprint.

6.4.5 Reduced system footprint

The power reductions (cited above) allow the solar power system to be downsized. The solar array (currently a 2 ft x 4 ft panel) can be reduced to a more manageable and less noticeable size. The solar system can be located outside of the hazard zone so that the glass arrays and the battery packs which could pose a collision hazard can be moved further away from the road.

6.4.6 Installation rules for RADS installation

Rules for the location of the beams have been developed which will promote more robust installations. The ability to perform field evaluations of potential station positions using portable, temporary beam transmitter and receiver stations has been developed and tested. STS believes that the ability to qualify beam installations prior to major construction activity is a prime requirement for the successful installation of RADS.

6.4.7 Satellite data service for remote access

The poor performance of the telephone line connection to RADS has encouraged the exploration of alternate communication methods to remotely access RADS. Daily (or hourly) status reports may be required to substantiate system operation over time. A satellite based system has been found which is tailored to this application. It is the intention that this system will be demonstrated at the site along US Hwy 191 in Yellowstone National Park.

6.5 SECOND GENERATION RADS PERFORMANCE

The second generation system is expected to resolve the issues found during the testing of the original RADS. One issue is improving the data link performance of RADS so that beam break events are more reliably reported to the master station. Currently, the original RADS station is operating error-free with the exception of two beams which were poorly located in the installation. Second generation location rules would eliminate poorly placed stations that exhibit bad data link behavior.

A side benefit of the second generation design is the reduction of power accrued with the change in the radio protocol, the reduction of transmitter duty cycle, and other incremental improvements. The reduction in power requirements allows a smaller system footprint, since the major visible part of the RADS station is the solar array and battery compartment.

6.5.1 Reduced power consumption

We expect to reduce the RADS power consumption to 10% of the current requirement. STS will no longer include traffic warning beacons with the RADS. The traffic warning system will be provided by the user with remote data support by RADS.

6.5.2 Radio link data protocol, error-free operation

By using the “on-event” protocol, the radio data link will require a beam break event to be acknowledged prior to being cleared. This change guarantees the transfer of the event from the receiver to the master station by eliminating “dropped” events.

6.5.3 Smaller system footprint

Reducing the power requirement dramatically reduces the system footprint. This is important, as this relates to landscape aesthetics which may be of special concern in areas such as Yellowstone National Park

6.5.4 Increased dynamic range

The use of a commercial antenna tightens the millimeter wave beam increasing the signal levels by 12 dB. Changes in the video amplifier and crystal detector may increase the dynamic range further. Increased dynamic range allows greater immunity to the environment (e.g., precipitation and vegetation interference).

6.6 CURRENT STATUS (DECEMBER 2005)

RADS at the Montana site is currently operational including the remote access capability. The beacons have been unplugged and the warning signs have been removed until the blind spots have been addressed (see Chapter 7). The radar is monitored daily by STS.

However, radio errors are still observed on the two southernmost stations. In addition, beam 1 is showing higher than normal beam breaks. This increase in activity is believed to be vegetation growing in the beam path.

7.0 RELIABILITY, EFFECTIVENESS AND ACCEPTANCE OF THE ANIMAL DETECTION SYSTEMS IN MONTANA AND PENNSYLVANIA

Authors: Marcel P. Huijser, Whisper Camel and Amanda Hardy
Western Transportation Institute, Montana State University
P.O. Box 174250, Bozeman, MT 59717-4250 (e-mail: mhuijser@coe.montana.edu)

7.1 INTRODUCTION

We estimate that there are 34 locations throughout Europe and North America that have or had an animal detection system in place (*Huijser and McGowen 2003*) (see also Chapter 4). Data on the effectiveness of animal detection systems are scarce, but data from Switzerland suggest that animal detection systems may lead to 82% reduction in the number of ungulate-vehicle collisions (*Kistler 1998; Romer and Mosler-Berger 2003; Mosler-Berger and Romer 2003*). Nonetheless, in order for such systems to be effective, it must first detect large animals reliably; however, few studies have documented such reliability data. Exceptions are e.g., Gordon, et al. (2001) and Kinley, et al. (2003).

In this chapter we describe the reliability of the two experimental animal detection systems in Montana and Pennsylvania. At the Montana site, in addition to reliability, we also investigated the characteristics of crossing events detected by the system, in order to estimate the duration that the warning signs should be activated, once a large animal is detected. Furthermore, we report on the status of the tests for system effectiveness and system acceptance. This chapter is partly based on Huijser, et al. (2006a). For technical details on the two systems see Chapter 5, and for technical modifications to the system in Montana, see Chapter 6.

7.2 SYSTEM RELIABILITY – MONTANA SITE

7.2.1 Status of system and warning signs

The system was installed in October and November 2002 (see also Chapter 4). The system suffered from a range of technological challenges (see Chapter 6 and Appendix C). Based on the analyses of patterns in the detection data, the system started to detect large animals reliably on 22 November 2004 (Table 7.1). These analyses relied solely on interpretation and were therefore at least partially subjective.

On 13 December 2004 the warning signs were attached to the system, and beacons were connected. The animal detection system was then found to have a problem. The software caused the detection data to overwrite code for radio messages after 15 days. This caused faulty radio reports, and the detection data were no longer transmitted to the master

station. If the beacons were flashing at that moment, the beacons were not shut off. This occurred on 31 December 2004, but the system seemed to have recovered by itself on 9 January 2005. The software may have been damaged, however, and the system may not have detected animals reliably. The date and time stamp may have been wrong as well. The detection system stopped recording information completely on 10 January 2005, but this date may not be correct either.

Table 7.1: Status of the animal detection system at the Montana site between Nov 2004 and Mar 2005

Period	Animal detection component	Driver warning component
22 Nov '04 - 13 Dec '04	Functional	Not connected
13 Dec '04 - 31 Dec '04	Functional	Connected
31 Dec '04 - 18 Jan '05	Not functional	Connected
18 Jan '05 - 26 Jan '05	Not functional	Not connected
26 Jan '05 - 5 Mar '05	Functional	Not connected
5 March '05 - 9 May '05	Functional, except for false positives in detection Zone 1 and 9	Not connected
9 May '05 - December '05	Functional, except for abundant false positives in Zone 1	Not connected

The problem with the software led to the removal of the warning signs and the disconnection of the beacons on 18 January 2005. The software was upgraded twice (26 January 2005 and 10 February 2005) to correct the overwriting of the code 15 days after system initialization and to allow for more radio communication time to reduce the number of failed radio contacts (see also Chapter 6).

The detection part of the system has been functional again since 26 January 2005, but the driver warning part was not re-activated (Table 7.1). However, there were episodes of abundant false positives in detection Zone 1 and to a lesser extent in detection Zone 9 (see Figure 7.1 for the location of the detection zones). The false positives in detection Zone 1 in winter and spring proved to be related to a broken bracket of the transmitter in detection Zone 0. This caused the transmitter to be out of alignment. As a result, the signal strength increased causing episodes of abundant false positives in the adjacent detection zone, Zone 1. The false positives in detection Zone 1 in summer appeared to be related to re-growth of shrubs in the path of the beam. This problem can probably be addressed by limited trimming. The less abundant false positives in detection Zone 9 were related to a severely damaged wire.

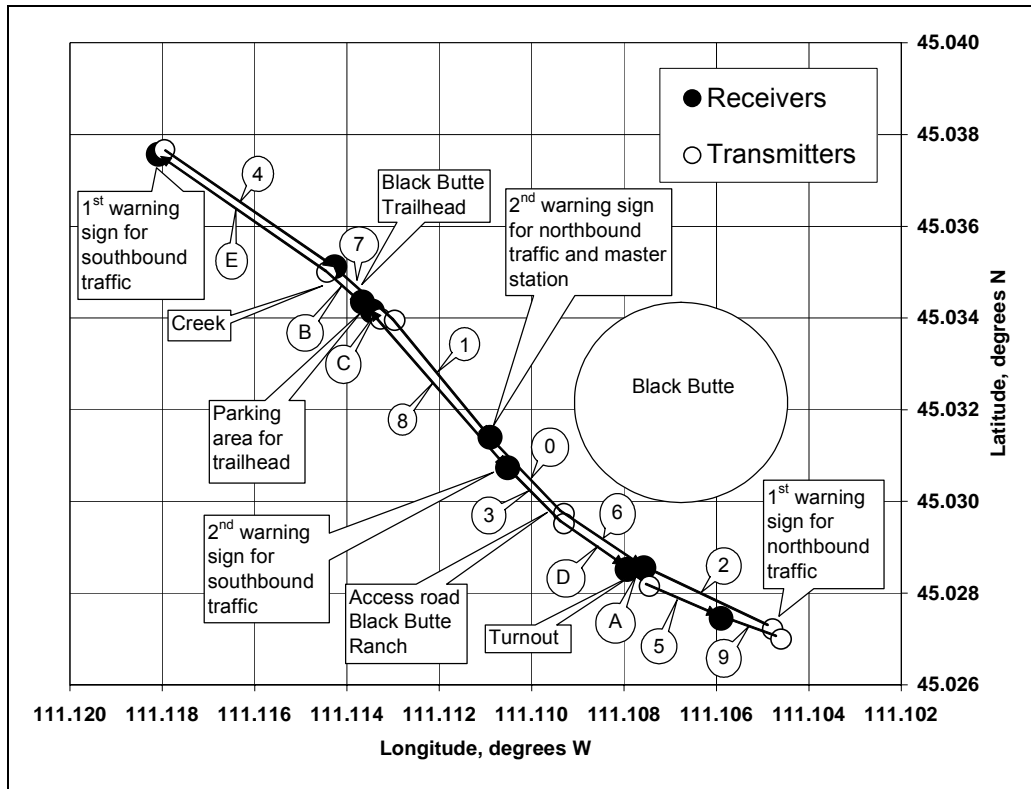

Figure 7.1: Schematic layout of the animal detection system and major road and landscape features at the study site (Source: STS). The numbers and letters represent the codes of the individual detection zones.

The following sections discuss the reliability of the system since software changes were made, 26 January 2005 – 5 March 2005. The reliability of the system was not only investigated based on interpretation of the patterns in the detection data but also by comparing the detection data with snow tracking data and by triggering the system at a known time at a known location and comparing these notes with the detection data. During the research period for system reliability (26 January 2005 – 5 March 2005), the warning lights were left unplugged, and the warning signs were not attached.

7.2.2 Methods

7.2.2.1 Reliability – Data interpretation

The detection data from 26 January 2005 to 5 March 2005 were extracted from the system. Data patterns were interpreted for three periods: 26 January – 14 February; 18 February – 21 February; and 25 February – 5 March (30 days in total). Seven categories were defined (Table 7.2). Detections caused by researchers working at the field site were excluded from all analyses. Each “day” started and ended with the arrival of the researchers at the site (usually in the morning hours) or, if the researchers did not visit that day, a “day” started and ended at noon (12:00 pm).

Table 7.2: Detection data categories

Category	Definition
Animal crossings	All detections that showed “something” crossed the road and triggered the system in detection zones on opposite sides of the road. This is synonymous with the term “crossing event”. Note: we included detections in the right-of-way that seemed to be related to the crossing (i.e., detections immediately before and after the crossing of the actual pavement).
Traffic/snowplow	A series of consecutive detections in adjacent sections with the direction of travel. The detections may be caused by snow spray from snow plows, signal reflections from large vehicles (buses/trailers) or vehicles driving close to the edge of the road.
Traffic Black Butte Ranch	All detections in detection Zone 3 between 7:00-23:00 hrs that had no match on the other side of the road.
Trailhead	All detections in detection Zone 7 between 7:00-19:00 hrs and that had no match on the other side of the road.
Error	Detections associated with a failed radio report or detections that occur simultaneously in adjacent sections.
Unclear	Detections that do not fall in any of the above categories and that cannot be readily explained based on the data patterns alone.

The interpretation of the data based on the detection patterns was at least partially subjective and subject to errors. This was particularly true for the category “unclear.” Although certain detections may have seemed random and did not seem to fit any particular pattern, they may very well have been related to real world events. For example, an animal walking in the right-of-way may trigger the system but the animal may not cross the road and may not trigger the system on the other side (Figure 7.2 and Figure 7.3). Alternatively, the animal may also cross the road much farther up or down the road, thus producing seemingly unrelated detections.

The beam with the microwave signals was not at a constant height above the ground. Rises or low areas, slopes and curves resulted in areas where the beam may shoot over an animal’s body or where it was very close to the ground (e.g., 45 cm (18 in)). Thus medium sized mammals such as coyotes but also relatively large mammals such as elk may have been detected in some areas and not in others, resulting in seemingly isolated and unrelated detections.

Traffic could also have caused isolated detections, especially in detection Zones 8, 9 and 1 where the beam was relatively close to the edge of the pavement. (For the location of the detection zones see Figure 7.1.) Thus vehicles that drove on the edge of the pavement could also have caused detections that may not fit any particular pattern, and these could be classified as “unclear” as well.

Other interpretation problems could occur if several animals crossed the beam at the same time; i.e., within 2 sec of each other. These crossings would be recorded as one beam break event rather than several. Thus the number of “animal crossings” or “crossing events” (see Table 7.2) detected by the system could underestimate the actual number of animals that crossed the road. This would be especially true for a gregarious species such

as elk. This underestimation would not affect the functioning of the system, but it was one of the factors that complicated data interpretation.



Figure 7.2: Elk tracks in the right-of-way, paralleling the road at the MT site. These movements in the right-of-way may classify as "unclear" detections when interpreting the detection data of the system. (Photo: Marcel Huijser, WTI-MSU)



Figure 7.3: Wolf tracks paralleling the road at the MT site (Photo: Amanda Hardy, WTI-MSU)

7.2.2.2 Reliability – Snow tracking

We conducted daily snow tracking sessions on both sides of the road for the full 1,609 m (1 mi) road length covered by the animal detection system for three periods; 26 January - 14 February; 18 February - 21 February; and 25 February - 28 February (Figure 7.4). The visits were mostly conducted in the morning hours. On the first day of each session we did not record any tracks, rather only erased all tracks present in the snow with a rake. Thus there were 25 days of snow tracking in total. On the following days for each session we recorded and erased all new tracks of large animals that crossed in between the transmitters and receivers of the animal detection system since the last visit. When an animal appeared to have crossed the road (Figure 7.5) we specifically looked for a matching track on the other side of the road. The snow track data were compared to the

detection data saved by the animal detection system to further investigate system reliability.



Figure 7.4: Whisper Camel (WTI-MSU) conducted most of the snow tracking after the system at the MT site started to detect large animals reliably. She points at wolf tracks in the snow. (Photo: Marcel Huijser, WTI-MSU)



Figure 7.5: Two elk tracks indicating two crossings at the MT site (Photo: Marcel Huijser, WTI-MSU)

Snow tracking is not without error either. Snow tracks may have been covered by fresh snow or snow spray from snow plows; or the wind may have caused snow to fill in the tracks. Snow tracks may also have disappeared or faded as a result of snow melt; or the snow may have disappeared altogether in certain areas, especially on the west- and south-facing slopes of the road bed. In addition, some animals may not have left tracks when there was a hard icy crust on top of the snow. Furthermore, the direction of travel of the animal may have been misinterpreted because of unclear snow tracks, and the number of animals traveling in a group may have been miscounted or improperly estimated (due to animals that step in each others tracks). Finally some tracks may have been simply overlooked. In some cases such tracks may have been identified the next day, in other cases they may never have been identified.

7.2.2.3 *Reliability – Blind spots*

Blind spots were areas within the road section equipped with the system where large animals may have passed between sensors without being detected. Testing for potential blind spots was done using a human (170 cm (5 ft 7 in)) as a model for elk. The human model passed through the detection zones at 20 m (21.9 yard) intervals on 5, 7 and 13 February 2005 (Figure 7.6). The location and time of each passage were recorded and compared with the detections recorded by the system. The human model walked well past the detection zone and allowed for a minimum of three minute intervals between consecutive passages to avoid desensitization of the beam. Locations where the system failed to pick up the model were identified as “blind spots.”



Figure 7.6: Investigation for potential blind spots. The tracks indicate where human models passed through the beam. (Photo: Marcel Huijser, WTI-MSU)

7.2.2.4 *Reliability norms*

The previous sections have described the different methods used to investigate system reliability. However, the authors also had to define what was considered reliable. For this study the authors used a range of parameters to describe how reliable the animal detection system was (Table 7-3). First it was found to be important that “crossing events” (see earlier) could be identified in the detection data (through data interpretation) and that the

system was able to detect large animals continuously during the period investigated without abundant false detections generated by the system (based on data interpretation).

In addition, it was important that the timing and direction of travel for crossing events would match local knowledge about the behavior of large animals in the area, specifically elk.

Furthermore, the authors wanted to see that elk crossings recorded through snow tracking could be linked to a crossing event detected by the system with a percentage of at least 80% and preferably 100%. Therefore different levels of reliability were defined for this quantitative parameter (see Table 7-3). Finally, the system was not allowed to have blind spots (failing to detect a large animal approaching the road).

Table 7-3: Parameters and definition for reliability norms

Parameter	Definition
Crossing events	Reliable: crossing events can be identified through interpretation of the data patterns. Unreliable: crossing events cannot be identified through interpretation of the data patterns.
System failures	Reliable: the system is able to detect large animals continuously during the period investigated without abundant false detections generated by the system or system failures (based on data interpretation). Unreliable: the system is not able to detect large animals continuously during the period investigated or abundant false detections are generated by the system or the system experienced general failures (based on data interpretation).
Local knowledge	Reliable: the crossing events match local knowledge about the behavior of large animals, especially elk. Unreliable: the crossing events do not match local knowledge about the behavior of large animals, especially elk.
Snow tracking	Absolute reliability: 100% of the elk crossings recorded through snow tracking can be linked to crossing events detected by the system. High reliability: 80%-99% of all elk crossings recorded through snow tracking can be linked to crossing events detected by the system. Medium reliability: 60%-79% of all elk crossings recorded through snow tracking can be linked to crossing events detected by the system. Low reliability: <60% of all elk crossings recorded through snow tracking can be linked to crossing events detected by the system.
Blind spots	Reliable: there are no blind spots in the road section equipped with the system. Unreliable: there are blind spots in the road section equipped with the system.

7.2.2.5 Warning signs

The warning signs and lights were not visible to the public during the study period. However, the authors were able to quantify how long the lights would have been activated given the number and timing of the recorded detections. In addition, the detection data were used to evaluate how long the warning lights should be activated after a detection event occurs.

7.2.2.5.1 Activation period per day

The number of detections was counted regardless of the potential cause, for each day between 26 January - 14 February, 18 February - 21 February, and 25 February - 5 March (30 days in total). In addition, the detection intervals were calculated (i.e., the time elapsed between consecutive detections). The number of detections per day, the detection intervals, and the three-minute activation period (see “animal detection system”) allowed the researchers to calculate the total period that the warning signs would have been activated for per day to evaluate whether the system’s real time warnings were more dynamic and different from permanent warning signs, which drivers may habituate to and thus are not considered very effective (e.g., *Pojar, et al. 1975; Sullivan and Messmer 2003*).

7.2.2.5.2 Activation period after a detection

Even though the warning lights were unplugged and the warning signs were not attached during the study period, the system was initially programmed to activate the warning lights for three minutes after a detection occurred (see also “animal detection system”). If a new detection occurred before the three minutes had elapsed, e.g., after 1 min 45 sec, the warning light clock started again, leaving the warning lights activated for an additional three minutes. In this example, the warning lights would have been activated for 4 min 45 sec in total.

The three-minute activation period was based on best professional judgment, as there is no documented evidence on how long it would take large animals (especially elk) to cross the road or how frequently they would be detected during such a crossing. The warning lights needed to remain active while the animal (elk) was in the process of crossing the road; however, keeping the warning signals on for a long time after a detection may jeopardize driver confidence in the system as the animals may no longer be visible in the immediate vicinity of the road, hence increasing the likelihood that drivers will ignore the warnings signals the next time they pass through the road section equipped with the system.

Thirty days of detection data were used to calculate the duration of crossing events (based on data interpretation, see Section 7.2.1.2.1) and the detection intervals for these crossing events (26 January - 14 February, 18 February - 21 February, and 25 February - 5 March). These data provided us with insight into the optimal activation period for the warning lights when a detection occurs.

7.2.3 Results

7.2.3.1 Reliability

7.2.3.1.1 Data interpretation

A scan of all the detection data showed no indication of “down time” for the animal detection part of the system between 26 January and 5 March 2005. The

number of detections per day did not show a consistent increase or decrease in the periods investigated (Figure 7.7). However, the number of detections was relatively high on 5 and 14 February and 3-4 March. The total number of detections per day varied between 16 and 139, with a median of 47 detections per day (Figure 7.7).

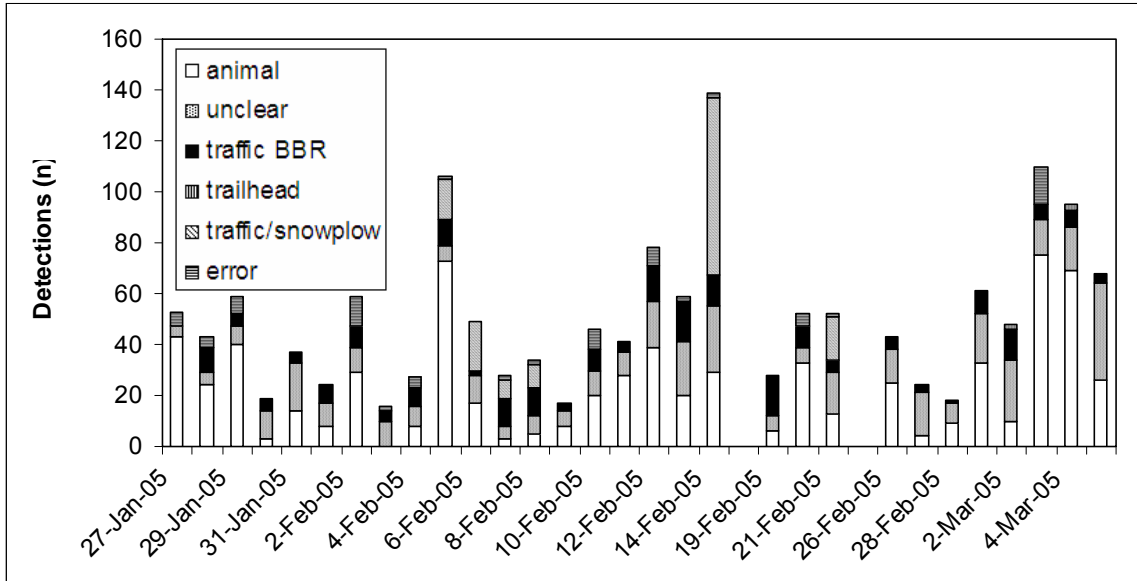

Figure 7.7: Number of detections per day between 26 January and 5 March 2005

Almost 47% of all detections were classified as crossings, 25% were classified as unclear, and 14% were classified as traffic on the Black Butte Ranch access road (Figure 7.8). A small number of the detections (0.3%) seemed to be related to hikers or skiers at the trailhead in detection Zone 7 (Figure 7.9). During the periods investigated, 9% of all detections were classified as caused by snow plows or other traffic (Figure 7.10), and 5% of all detections were classified as errors.

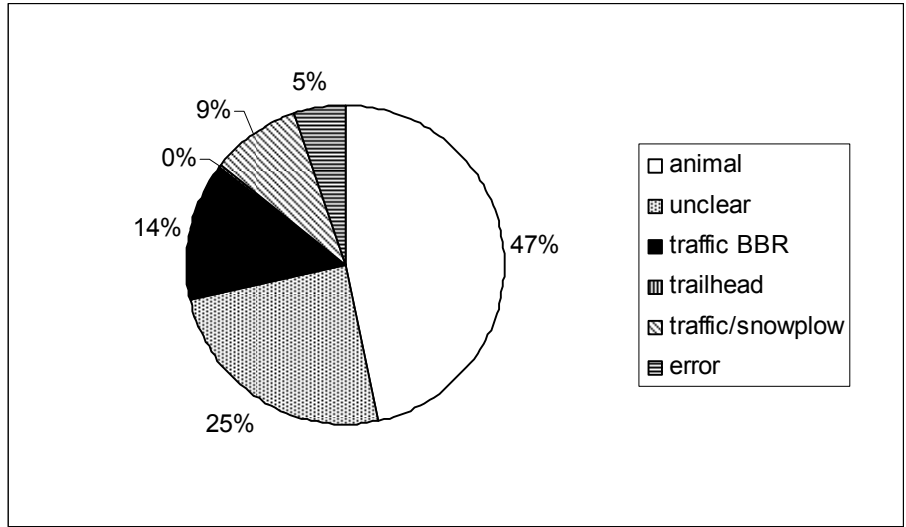

Figure 7.8: Percentage of detections per category (n = 1533) between 26 January and 5 March 2005



Figure 7.9: Hikers and cross-country skiers at the Black Butte trailhead triggered the system as well (Photo: Marcel Huijser, WTI-MSU)



Figure 7.10: Snow spray from a snow plow at the MT site. Depending on the amount of snow spray, how far the snow is thrown into the right-of-way, and the location of the beam, snow spray can trigger the system. (Photo: Marcel Huijser, WTI-MSU)

The detection data that were classified as animal crossings were split into westward and eastward movements, based on which side of the road detected the movement first and last. The detection data were then grouped per hour (Figure 7.11). Most of the westward movements occurred between 22:00 and 5:00 with a peak between 1:00-2:00. Most of the eastward movements occurred between 1:00 and 8:00 with a peak between 6:00 and 8:00.

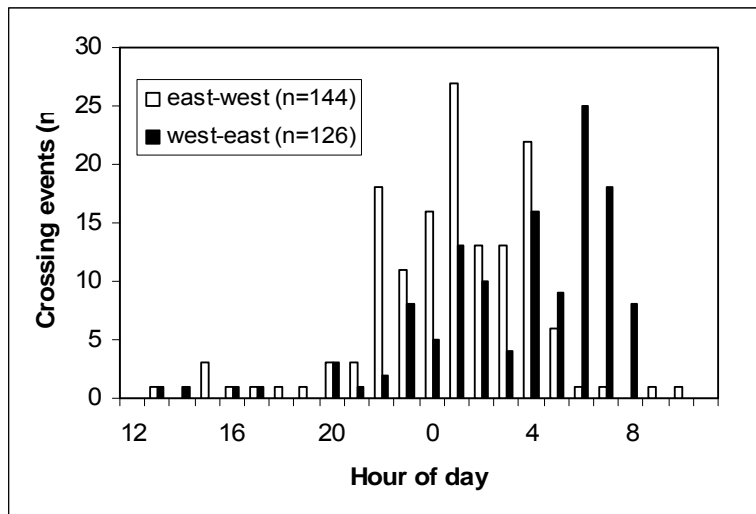

Figure 7.11: Number of crossing events detected by the system per hour of day for east- and westward movements between 26 January and 5 March 2005

7.2.3.1.2 Snow tracking

Within the investigated period WTI researchers encountered the tracks of three medium or large mammal species. Only clear animal crossings characterized by snow tracks approaching and leaving the road on opposite sides were counted. Tracks indicating clear crossing were encountered for the following species: elk (n=104), coyote (n=41) and wolf (n=3) (Figures 2.12 – 7.15).



Figure 7.12: Elk track at the MT site. The snow was not always fresh; it often had an icy crust on top which caused less than perfect tracking conditions. (Photo: Marcel Huijser, WTI-MSU)



Figure 7.13: Coyote track at the MT site (Photo: Marcel Huijser, WTI-MSU)



Figure 7.14: Wolf track at the MT site (Photo: Amanda Hardy, WTI-MSU)



Figure 7.15: Wolf and coyote tracks at the MT site (Photo: Marcel Huijser, WTI-MSU)

For an overall comparison of the spatial distribution between the detection data and the snow tracking data, researchers plotted the animal crossings recorded through snow tracking for each detection zone combination (Figure 7.16) and did the same for the crossing events recorded by the system (Figure 7.17). The pattern of crossing frequencies for the different detection zone combinations was similar for the detection and snow tracking data, especially for elk. Most crossings occurred between detection Zones E and 4 on the north end of the road section covered by the system. The snow tracking data confirmed that it was mostly elk that crossed the road there. Coyotes crossed throughout the road section covered by the system, while the limited number of wolf crossings all occurred in detection Zone 8 (see Figure 7.1 for zone location).

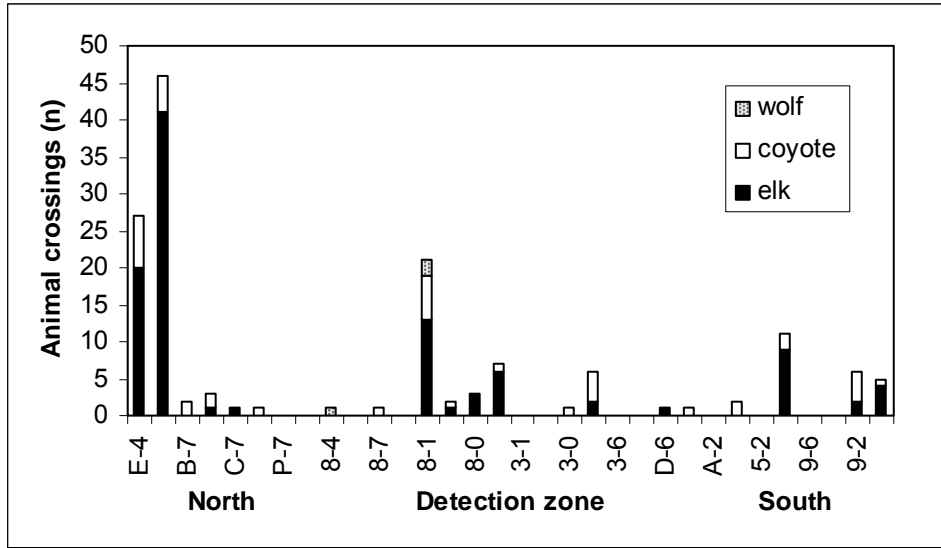

Figure 7.16: Number of recorded elk, coyote and wolf through snow tracking between 26 January 2005 and 28 February 2005. (See Figure 7.1 for the exact location of the detection zones.)

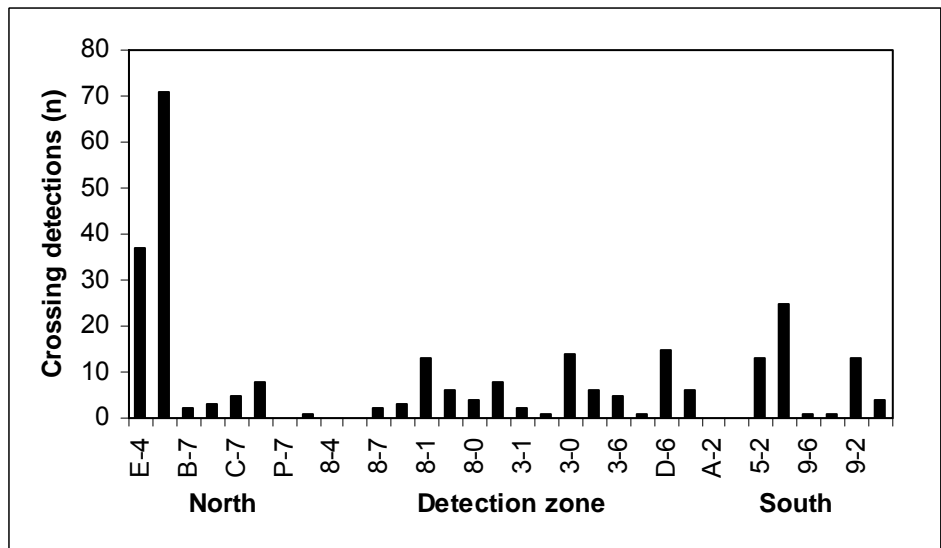

Figure 7.17: Number of crossings based on interpretation of the detection data between 26 January 2005 and 28 February 2005. (See Figure 7.1 for the exact location of the detection zones.)

A day-by-day and detection zone by detection zone comparison showed that 87% of all recorded elk crossings and 2% of all recorded coyote crossings were detected by the system (Table 7.4). However, some elk crossings were not detected by the system (Table 7.5). In addition, not all crossing detections by the system could be confirmed through snow tracking. Matching snow tracks were found in only 38.4% of all crossing detections (56 out of 146).

Table 7.4: Recorded crossings through snow tracking vs. crossings detected by animal detection system

Species	Snow track crossings (n)	Detected (n)	Detected (%)
Elk (<i>Cervus elaphus</i>)	104	90	86.5
Coyote (<i>Canis latrans</i>)	41	1	2.4
Wolf (<i>Canis lupus</i>)	3	0	0

Table 7.5: Detection zones where elk crossings were recorded through snow tracking but not by the animal detection system

Detection Zones	Direction of travel	Snow track crossings (n)		Detection Zones	Direction of travel	Snow track crossings (n)
0-8	East-west	5		1-8	East-west	1
8-1	West-east	4		4-E	East-west	1
0-3	East-west	2		7-B	East-west	1

7.2.3.1.3 *Blind spots*

The animal detection system detected the human model on most locations in most detection zones (Figures 7.18 and 7.19). However, there was a very substantial blind spot in detection Zone 8, and to a lesser extent in detection Zones B, 0, 3, 6 D, 5, 2 and 9 (see Figure 7.1 for location), potentially 17.8% of the total length covered by the sensors.

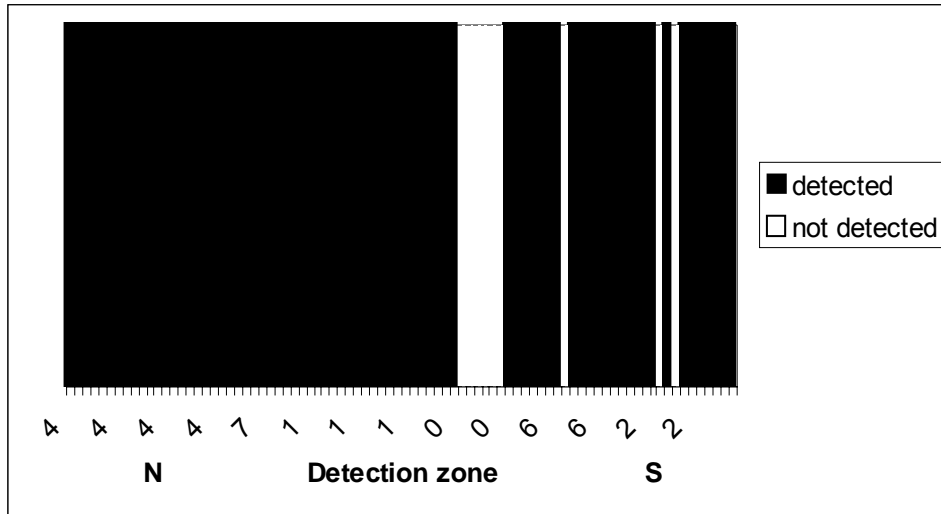

Figure 7.18: Blind spots of the detection zones on the east side of the road (see Figure 7.1 for exact location)

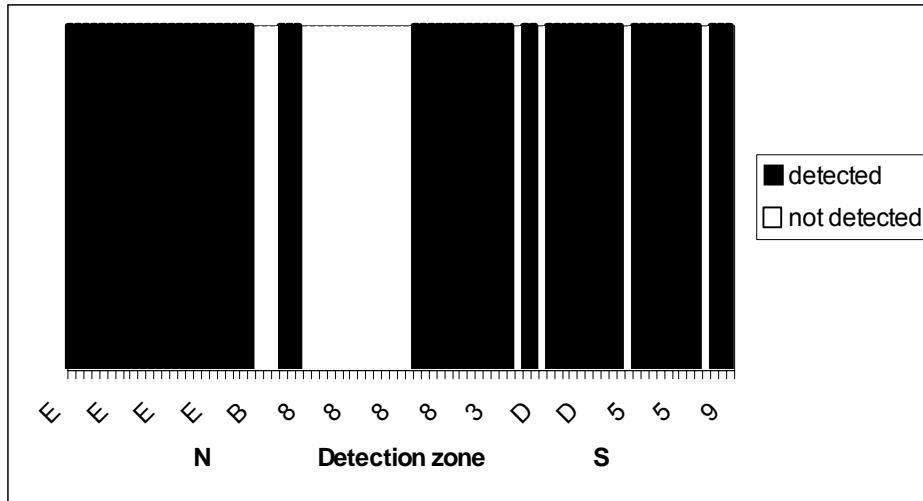

Figure 7.19: Blind spots of the detection zones on the west side of the road (see Figure 7.1 for exact location)

7.2.3.1.4 Reliability norms

The system was found to be reliable with regard to the presence of clear crossing events in the detection data, the absence of indication of system failures, and the match between the timing and direction of the crossing events and local knowledge about the behavior of the elk (Table 7.6). In addition, the system was found to be highly reliable with regard to the percentage of elk crossings detected by the system (87%); however, the reliability with regard to this parameter was not absolute. Finally, the system was found to be unreliable with regard to the presence of blind spots.

Table 7-6: Reliability evaluation of the animal detection system

Parameter	Definition
Crossing events	Reliable: crossing events could be identified through interpretation of the data patterns.
System failures	Reliable: the system was able to detect large animals continuously during the period investigated without abundant false detections generated by the system or system failures (based on data interpretation).
Local knowledge	Reliable: the crossing events matched local knowledge about the behavior of large animals, especially elk.
Snow tracking	Highly reliable: 87% of all elk crossings recorded through snow tracking could be linked to crossing events detected by the system.
Blind spots	Unreliable: there were blind spots in the road section equipped with the system.

7.2.3.2 Warning Signs

7.2.3.2.1 Activation period per day

The flashing warning lights were programmed to flash for 3 minutes after the last detection. Assuming there was at least 3 minutes of interval between consecutive detections, the flashing warning lights would have been activated for 141 minutes (2 hr 21 min) on a day with 47 detections (see Figure 7.7). However, most detections were highly clustered and had much shorter time intervals between them (Figure 7.20). The median interval between consecutive detections was 1 min 33 sec, resulting in 73 minutes (1 hr 13 min) of activated warning lights on a day with 47 detections. The graph in Figure 7.20 was cut off at 25 min; the longest detection interval was 17 hr 39 min.

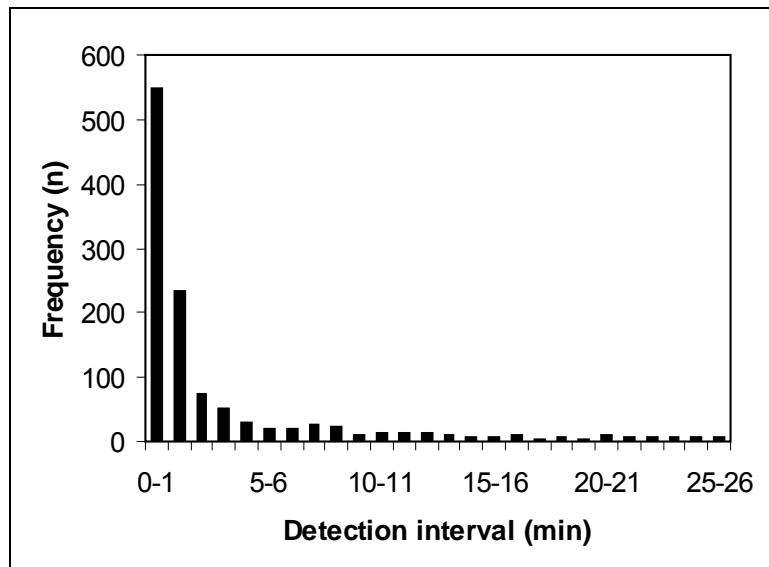

Figure 7.20: Frequency distribution of the detection interval between consecutive detections for detections between 27 Jan 2005 and 5 Mar 2005

7.2.3.2.2 Activation period after a detection

Most crossing events (72.6%) took less than 3 minutes to complete (from the first to the last detection), but some crossing events took much longer (Figure 7.21). In addition, crossing events involving multiple individuals (based on the patterns in the detection data) tended to take longer than crossing events that suggested that only one individual crossed. However, it is quite possible that the latter category could have included crossing events where multiple individuals traveled close together as these would have only caused one detection on each side of the road. Overall, the median duration of a crossing event was 1 min 29 sec. The graph in

Figure 7.21 was cut off at 25 min; the longest duration of a crossing event was 1 hr 10 min.

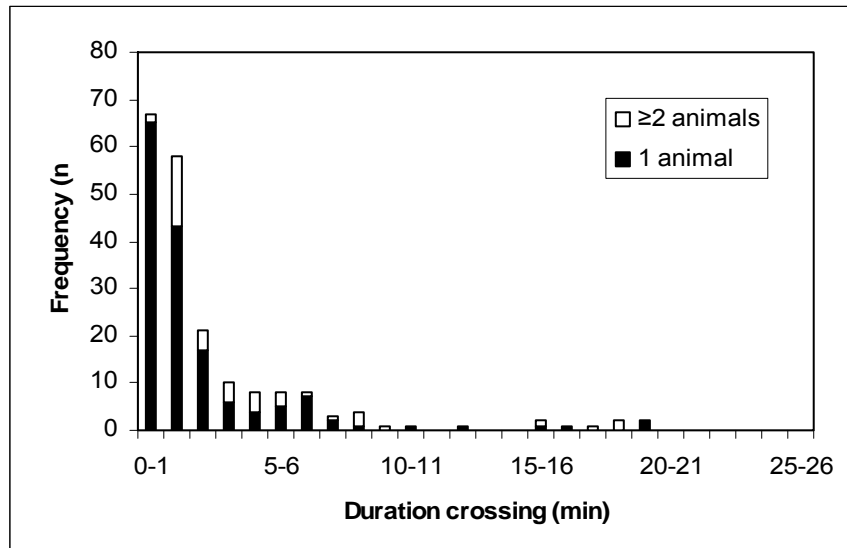

Figure 7.21: Frequency distribution of the duration of crossing events between 27 Jan. 2005 and 5 Mar. 2005

Most detection intervals (65.7%) for crossing events were less than 1 minute (Figure 7.22). The median detection interval was 38 sec. The line representing the cumulative percentage of the detection intervals (Figure 7.22) indicates that 88.1% of all detection intervals for crossing events would be covered if the warning lights remain activated for 3 minutes after the last detection. Should the warning lights remain active for 4 minutes after the last detection, this percentage would increase only slightly from 88.1% to 90.8%. However, decreasing the warning period to 2 minutes would result in a more substantial change from 88.1% to 81.8%.

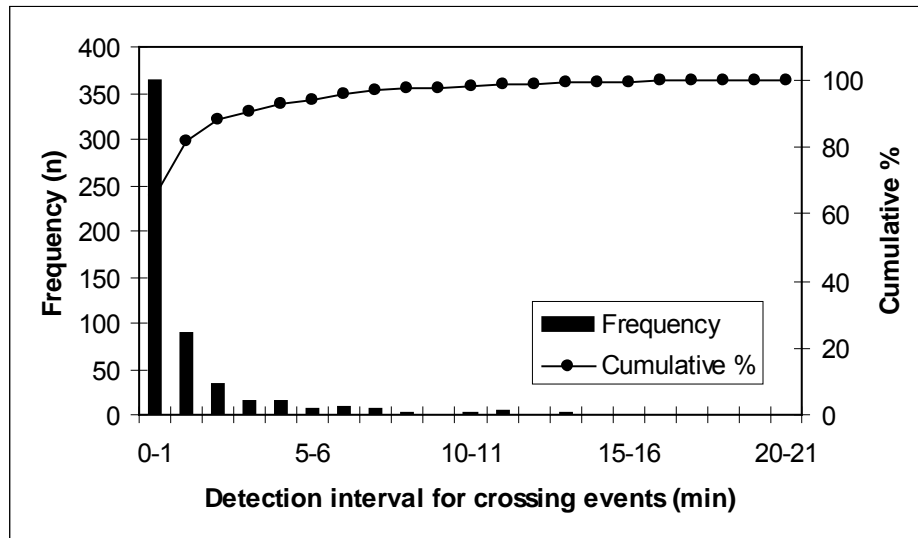

Figure 7.22: Frequency distribution of the detection interval between consecutive detections for the crossing events between 27 Jan. 2005 and and 5 Mar. 2005

Each crossing event was categorized based on the longest detection interval for each crossing, and how long a warning period (in minutes) after a detection would have been required to keep the warning lights continuously activated while the crossing event was still in process (Figure 7.23). For example, if the longest detection interval during a crossing event was 2 min 41 sec, then a 3-minute warning period would have been required to prevent the warning lights from having turned off before the crossing event was completed. With a 3-minute warning period 78.1% of all crossing events would have had the warning lights continuously activated during the crossing event (Figure 7.22). Increasing the warning period to 4 minutes would result in a slight increase from 78.1% to 82.6%. However, decreasing the warning period to 2 minutes would result in a more substantial change from 78.1% to 68.2%.

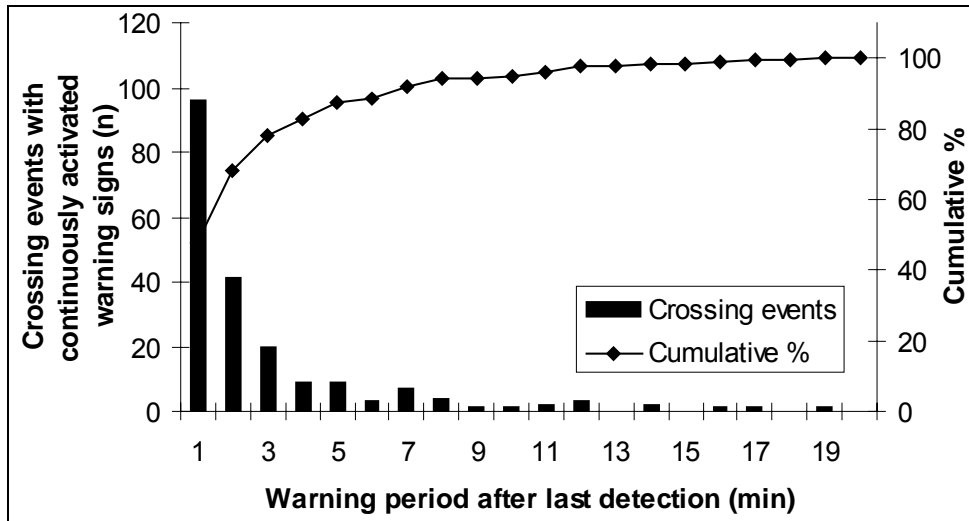

Figure 7.23: Number of crossing events with warning lights activated during the entire crossing event, based on crossing events between 27 Jan and 5 March 2005

7.2.4 Discussion

7.2.4.1 Reliability

The patterns in the detection data indicated that at least 47% of all detections were related to animals crossing the road. However, it is likely that some of the detections currently classified as “unclear” were also related to animal movements. Therefore the 47% value should be seen as a minimum estimate. The percentage of suspicious detections, potential system-generated errors, was estimated at 5% and was mostly due to failed radio reports from detection Zone 5 and 9 (see Figure 7.1 for location). The station that had the receivers for these two detection zones may have lacked a straight line of sight with the master station and may have had signal reflection off a rocky slope. However, within the investigated periods there was no indication of a high number of highly suspicious detections or false detections generated by the system. The system seems to have been detecting animals between 26 January 2005 and 5 March 2005 without system failures, and the system seems to have been stable during this period.

The distribution of detected animal crossings over the day and the direction of travel matched local knowledge about the behavior of the elk herd (see Section 7.2.1.2). The elk usually spend the day on the forested slopes. In the evening the elk travel down the slopes and cross the road to feed on the grasses and shrubs in the valley bottom. In the morning they leave the valley bottom, cross the road and travel up the forested slopes. The match between the patterns in the detection data and local knowledge seems to confirm that the system is able to detect large animals, specifically elk. In addition it suggests a correct interpretation of the detection data and a correct identification of crossing events.

The number of detected crossing events for each detection zone combination closely matched the number of recorded elk crossings through snow tracking. Detection Zone E

and 4 (see Figure 7.1 for location) had cover close to the road and were by far the most heavily used zones by elk when they crossed the road. This was also where the majority of all crossing events were detected by the system. Again, this seems to confirm the ability of the system to detect elk and it also suggests a correct interpretation of the detection data.

Almost 87% of all elk crossings recorded through snow tracking could be linked to a crossing event detected by the system. Assuming that the crossings detected by the system were indeed caused by animals, 38% of these detected crossings were confirmed through snow tracking. These percentages, especially the second one, may not seem high or high enough, but there are errors associated both with the interpretation of detection data and with snow tracking (see Section 7.2.1.2). These percentages also suggest that elk or other large mammals crossing the road may be more reliably identified through interpretation of the detection data than through snow tracking, at least under the conditions that were present at the study site (see Section 7.2.1.2). Medium-sized mammal species such as coyotes and wolves were not detected or rarely detected by the system.

The system detected a human model passing through the detection zones at most locations. However, a substantial blind spot was identified in detection Zone 8 and to a lesser extent in detection Zones B, 0, 3, 6, D, 5, 2 and 9 (see Figure 7.1 for location), potentially 17.8% of the total length covered by the sensors. The blind spots in detection Zones 8, B, 3, and D were the result of curves and slopes that made the beam shoot over the head of the model in some areas. The blind spots in detection Zones 5 and 9 may be related to radio failures rather than true blind spots. The blind spots in detection Zones 0, 6 and 2 require additional investigation, as the terrain seems relatively level and straight. It is not unlikely that the detections missed in detection Zones 0, 6 and 2 were the result of desensitization of the beam; they may not be a true blind spot. Desensitization of the beam can occur when a human model, large wildlife species or other objects stay in the beam path for a prolonged time. This causes the noise levels to increase which no longer allows the system to detect the target species. Nevertheless, the test indicated that the system should be able to detect elk passing through the detection zones at most locations, especially where they cross most frequently (detection Zone E and 4).

The presence and location of blind spots in the system, especially in detection Zones 8 and B, may also explain why some of the elk crossings were not detected by the system. Indeed, 11 of the 14 elk crossings that were not detected by the system were located in detection Zone 8 or B. This suggests that the 87% detection rate for elk (see earlier) could be substantially higher (up to 97%) if the blind spots of detection Zones 8 and B are addressed.

7.2.4.2 Warning signs

Based on a median of 47 detections per day and a median detection interval of 1 min 33 sec, the total time that the flashing warning lights would be activated was 1 hr 13 min per day. This is a marked difference with permanently activated warning signs, which tend to

be ignored by drivers. The real-time activation of the warning lights after a detection event could potentially lead to increased driver response.

Most crossing events (72.6%) were completed within 3 minutes, and the median duration of a crossing event was 1 min 29 sec. The interval between the detections that occurred during a crossing event was typically less than 1 minute (65.7%), with a median of 38 sec. However, longer detection intervals did occur, and “only” 88.1% of all detection intervals for crossing events would be covered if the warning signs were activated for 3 minutes after the last detection. With a 3-minute warning period after the last detection, 78.1% of all crossing events would have had the warning lights continuously activated during the crossing event. One may be tempted to increase the duration of the warning time from 3 to e.g., 4 minutes, but this may only result in a marginal improvement in coverage of the detection intervals for crossing events (2.7%) and the number of crossing events with continuously flashing lights (4.5%) while making the warning signals substantially less time specific (an increase in warning period after the last detection of 33.3%).

7.2.5 Conclusion

The patterns in the detection data suggest that most detections by the system were probably related to real world events, and that at least half of all detections appear to be related to large animals, specifically elk, approaching or leaving the road. In addition, the patterns in the detection data show no indication of system failures or abundant false detections. The crossing events detected by the system match local knowledge about the behavior of the elk. The spatial distribution of the elk crossings observed through snow tracking matches that of the crossing detections. A high percentage of all elk crossings observed through snow tracking could be linked to crossing events detected by the system. In conclusion, the system detects large animals reliably. However, depending on the location, and potentially also depending on the conditions (e.g., weather), the system does not detect all large animals that approach or leave the road.

In addition, researchers concluded that the total period the warning lights would be activated for per day is relatively short, especially when compared to permanently activated warning signs, potentially resulting in increased driver response. Furthermore, the 3-minute period that the warning lights are activated for after a detection appears to be a good balance between keeping the warning lights on while the animal (elk) is still in the process of crossing the road, and not presenting drivers with activated warning lights longer than necessary.

Despite these conclusions, it is recognized that other researchers or transportation agencies may want to evaluate additional or different reliability parameters than used for this study. In addition, others may want to see a higher or lower level of reliability for an animal detection system, especially in relation to potential liability in case of an accident. It is understood that the responsible transportation agency will decide what the optimal warning period for an animal detection system should be.

7.2.6 Recommendations

Even though WTI researchers concluded that this animal detection system appears to detect elk reliably, there are blind spots in the system as a result of design errors. For future projects it is recommended that the location of the posts and sensors, especially at curves or slopes, be carefully evaluated to ensure that the detection beam stays close enough to the ground to be able to detect the target species. However, even if the location of poles and sensors is carefully evaluated one should never assume that an animal detection system detects all animals that approach or cross the road under all circumstances. Therefore one should avoid the use of warning signs that suggest that elk are only present on or near the road when the warning signals are activated. Instead the authors suggest using signs that urge drivers to increase their alertness (see *Katz, et al. 2003*), indicating that drivers should always be alert and that they should always be prepared to stop for large animals on or near the road, regardless of whether the warning signs are activated.

WTI researchers also recommend that the blind spots in detection Zone 8 and B (see Figure 7.1) be addressed through the installation of additional posts and sensors. Also recommended is a further evaluation of the blind spots in the other detection zones to determine whether they are real and how short (isolated) blind spots may be addressed. Furthermore, the number of unsuccessful radio contacts for some stations should be reduced (especially for detection Zones 5 and 9, see Figure 7.1), either through moving the master station to the west side of the road or through more fundamental changes to the communication system.

The following recommendations are also important, as they relate to the reliability and robustness of the system. WTI researchers learned that the brackets that hold the sensors in place can break as a result of extreme temperature fluctuations. These brackets should be secured or replaced to avoid potential false detections or system downtime. In addition, periodic vegetation management is required. High, wet and moving vegetation can result in false detections, they can cause a serious reduction in signal strength, and they may result in the temporary deactivation of the detection zone concerned.

Furthermore, developing standards for the reliability of animal detection systems and testing of other animal detection system technologies from various manufacturers is recommended. Investigating the effectiveness of a variety of warning signs and signals is suggested, with regard to driver response and potential liability for transportation agencies in case of an accident. Despite the encouraging results from Swiss research (*Kistler 1998; Romer and Mosler-Berger 2003; Mosler-Berger and Romer 2003*), more and better data are required on the effectiveness of animal detection systems, especially with respect to the potential reduction in animal-vehicle collisions. Keeping log books to document the operation and maintenance costs of animal detection systems is imperative. Finally, miniaturization of animal detection systems to address landscape aesthetics concerns and safety issues for equipment placed in the right-of-way is recommended.

7.3 SYSTEM RELIABILITY – PENNSYLVANIA SITE

The system was installed in May 2004 (see also Chapter 4). The system suffered from a range of technological challenges (see Chapter 8 and Appendix C). A reliability test was done on 18 November 2004. PennDOT and WTI-MSU staff triggered the system with human models at known times and at known locations and recorded whether the flashing lights were activated (Figure 7.24) (see Appendix H). The system should have been triggered almost constantly during the 42 min 15 sec testing period. However, the system was only activated 20 times (for 1-2 seconds at a time, based on the current settings for the beacons). The system was usually not activated when human models ran 10-25 m in front of and around multiple sensors.

Detailed detection data that would have shown which detection zone caused the beacons to flash were lost (Dennis Henningsen, Oh DEER, Inc., personal communication).



Figure 7.24: Jon Fleming (PennDOT) approaching one of the stations at the PA site to test the reliability of the system (Photo: Marcel Huijser, WTI-MSU)

Known problems of the system included power problems with the solar panels and batteries, problems with sensors distinguishing between moving vehicles and deer or similar sized animals, false negatives, and a wrong orientation for some of the detectors.

7.4 SYSTEM EFFECTIVENESS TESTS

7.4.1 US Hwy 191, Yellowstone National Park, MT

The reliability tests showed that the system was indeed able to detect elk reliably, starting in November 2004. While the warning signals and signs were up between 13 December 2004 and

18 January 2005, they were not reinstalled before the end of phase 1 (31 December 2005). Therefore the effectiveness of the animal detection system – with regard to a potential reduction in vehicle speed and a potential reduction in animal-vehicle collisions – could not be evaluated during Phase 1. The effectiveness of the system will be evaluated in Phase 2 of the research project.

7.4.2 Hwy 22/322, near Thompsontown, PA

The reliability test showed that the system did not reliably detect humans (a model for deer). Therefore the effectiveness of the system, both with regard to a potential reduction in vehicle speed and a potential reduction in animal-vehicle collisions, was not evaluated.

7.5 SYSTEM ACCEPTANCE

7.5.1 US Hwy 191, Yellowstone National Park, MT

Throughout the history of this project, WTI-MSU documented the concerns and issues related to the acceptance of the animal detection system. Not surprisingly, stakeholders with various roles in the project had different points of view. Park managers had concerns about hosting the system in Yellowstone National Park (YNP). The Montana Department of Transportation (MDT) brought up matters related to the ownership, operation and maintenance of the system, as well as potential liability in case of an accident. Local residents and visitors to the region provided opinions through letters to Yellowstone National Park and some local newspapers. These viewpoints are summarized below to gain a better understanding of the factors that influence the acceptance of animal detection systems.

YNP had several types of concerns about the system, including aesthetic suitability to the Park, operational reliability, and long-term management and maintenance. As a National Park, YNP places a high priority on landscape aesthetics and judged the animal detection system to be large, unsightly for the setting, and potentially obtrusive to motorists. YNP also stated that they received comments (an unknown number) from the public expressing similar concerns about the large dimensions of the system.

Once the system was installed, YNP expected that the animal detection system would quickly become operational and reliable. YNP did not anticipate the technological challenges and the delays before the system finally started to detect elk reliably in November 2004, two years after the system has been installed.

In regards to long-term management of the system, YNP was concerned that MDT would not accept ownership and the responsibility for operation and maintenance, which YNP felt was not acceptable to the visitors to the Park and the travelers on that section of Hwy 191. Because MDT did not accept ownership of the system, the management plan for the system that described the procedures for addressing operational problems with the system was not in effect.

Based on the results of the reliability research (see earlier in this chapter), WTI-MSU proposed modifications that would address the blind spots of the system (discovered in March 2005), and a

potential upgrade to a “next generation system” that would have much smaller dimensions. However, since the project had not met YNP’s expectations regarding operational reliability, YNP asked for the removal of the animal detection system before 15 September 2005. However, after the Technical Advisory Committee (TAC) for the project (see Appendix A) presented the results on the reliability of the system to YNP in greater detail, YNP agreed to keep the animal detection system in place until 31 August 2008 to allow for system modifications to address the blind spots and the evaluation of the effectiveness of the system. In exchange for allowing the project to continue, YNP set several requirements. The most important requirements relate to the allowable down time of the system and acceptance of ownership and responsibility for operation and maintenance by MDT.

Before MDT can assume ownership and responsibility for a new system, the agency must ensure that the system meets required specifications, and that liability and institutional concerns have been adequately addressed. MDT had several significant concerns regarding the system. First, the communication system of the animal detection system did not meet the required specifications, and the system suffered from false positives, false negatives, and downtime. After the system was modified and after the system started to detect elk reliably (November 2004), further tests were required to show that the system was indeed detecting elk reliably. While the test results confirmed that the system detected elk reliably, they also showed the presence of several blind spots. Even though these blind spots were not located in the road section that elk most frequently crossed, they could result in false negatives which in turn may lead to liability in case of an accident. MDT stated that they would like to either modify the system or upgrade it to a “next generation system” at the same location. A final condition of MDT was that YNP had to support such an effort. As a result of all these factors, MDT did not assume ownership of the animal detection system, nor responsibility for operation and maintenance. However, after the blind spots of the systems have been addressed, MDT will reevaluate its position.

Individuals who lived in the immediate vicinity of the animal detection system were mostly supportive of the research and the goal to reduce animal-vehicle collisions; however, they did express their concern about the dimensions of the system (e.g., Duncan Patten, Black Butte Ranch, personal communication).

WTI-MSU did not survey drivers about their opinion of the animal detection system, because they may not have been aware of the purpose of the equipment along the roadside without the warning signs and signals being present. In addition, drivers may have to be exposed to a reliable system for some time before they learn that they can trust the system (see Chapter 3).

Although the system reliability was eventually established, the overall acceptance of the system must nonetheless be characterized as poor, at least up until December 2005. The project partners had concerns about the reliability of the system, particularly the blind spots; and both the host agency and the public shared concerns about the obtrusive nature and size of the equipment. In the future, animal detection instrumentation will need to either be “invisible” to the public or blend in with the surrounding landscape better if deployed in settings where aesthetics are a major concern.

7.5.2 Hwy 22/322, near Thompsontown, PA

WTI-MSU evaluated the acceptance of the animal detection system by consulting with the project partner who would (eventually) own, operate and maintain the system – Pennsylvania Department of Transportation (PennDOT)).

PennDOT had significant concerns about the effectiveness of the system and the relationship with the vendor. The animal detection system experienced a range of technological challenges immediately after installation. While this was an obvious concern, PennDOT was willing to work with the vendor and assist with problem identification and modifications to the system.

However, the communication with the vendor was a great concern to PennDOT. The vendor did not provide a clear overview of the problems, the status of the problem identification process, a strategy to address these problems, or a time schedule for their work when required. Finally, the system failed to detect human models reliably during the reliability test on 18 November 2004 (see earlier in this chapter). The funders (the 15 Departments of Transportation and the Federal Highway Administration; see Chapter 1) asked WTI-MSU to terminate the contract with the vendor and to ask the vendor to remove the system before 31 January 2005.

WTI-MSU did not survey drivers about their opinions of the animal detection system, because they may not have been aware of the purpose of the equipment along the roadside without the warning signs and signals being present. In addition, drivers may have to be exposed to a reliable system for sometime before they learn that they can trust the system (see Chapter 3).

As a result of all these factors, the system was not accepted by PennDOT. The main reasons were the unreliability of the system and poor communication by the vendor.

8.0 LESSONS LEARNED FROM THE ANIMAL DETECTION SYSTEM PROJECTS IN MONTANA AND PENNSYLVANIA

Authors: Marcel P. Huijser, Patrick T. McGowen, Patrick Wright, Amanda Hardy and Anthony P. Clevenger

Western Transportation Institute, Montana State University

P.O. Box 174250, Bozeman, MT 59717-4250 (e-mail: mhuijser@coe.montana.edu)

8.1 INTRODUCTION

The work involved in deploying the two experimental animal detection systems resulted in valuable experience related to the planning and design, installation, operation and maintenance, and evaluation of animal detection systems. However, one of the two experimental animal detection systems (Pennsylvania site) was found to be unreliable, and the effectiveness of the other system (Montana site) could not be evaluated before Phase 1 of the project ended (31 December 2005). Nonetheless, the system at the Montana site was able to detect large animals reliably, and the effectiveness of the system will be evaluated in Phase 2 of the project.

This chapter summarizes the challenges encountered with the two animal detection systems and their respective project environments, in order to increase the understanding of the lessons learned during the planning and design, installation, and operation and maintenance phase of the systems. Many of the challenges encountered and lessons learned are based on the monthly reports that were provided to the funders throughout the project. A summary of these monthly reports and the project history are provided in Appendix C.

8.2 CHALLENGES ENCOUNTERED

8.2.1 US Hwy 191, Yellowstone National Park, MT

The most significant challenges encountered with the animal detection system and the project environment in Montana are listed below. The summary is based on the information in Appendix C. A chronological order is followed whenever possible.

8.2.1.1 Planning and design

The project experienced many delays, starting during the design and planning phase. Causes for the delays during this phase were related to several factors:

- Certain system components no longer available to the vendor;
- Consequent changes in detection technology and an increase in costs;

- Unfamiliarity of the vendor with laws and regulations for deployment in a roadside environment;
- Management changes in the maintenance division of the Montana Department of Transportation (MDT);
- Concerns of Yellowstone National Park (YNP) with regard to the dimensions of the system;
- Requirements of YNP with regard to the materials used (e.g., wooden poles instead of metal posts) and the paint color of the equipment; and
- Requirements with regard to vegetation and topsoil during system installation.

Many of these issues were the result of a general underestimation of the design and planning phase. The original system in the vendor's proposal included a transmitter and receiver on one pole and a reflector on the next pole ¼ mile away. This implied, for the one-mile segment, four poles with power and detectors and six with reflectors. In the end the system had 18 poles, all with power and equipment. In addition, the vendor may not have fully understood the requirements from YNP or MDT, at least not during the early phases of the project. In an attempt to make a successful design WTI-MSU took on some of the vendor's work, including meeting with YNP and MDT to review draft designs, surveying and measuring the installation site, and designing and providing poles for the system.

8.2.1.2 Acceptance of design plans

Even though YNP still had concerns about the dimensions of the system, the project moved forward. However, this may have affected YNP's support for and acceptance of the project from the onset.

8.2.1.3 Payments to the vendor

The Western Transportation Institute at Montana State University (WTI-MSU) released 90% of the funds to the vendor upon and before the delivery of the system, but prior to installation and verification that the requirements of the request for proposal and the contract had been met. The payments were necessary to allow the vendor to continue with the design and planning of the system, as well as the purchase of the system components and preliminary testing. However, after receiving the majority of the funding, the vendor had little immediate financial incentive to address the problems that occurred after the installation of the system.

8.2.1.4 System deployment

Initially MDT maintenance was to install the system delivered by the vendor. However, MDT's reorganization of its maintenance division lowered the priority of the animal detection system project and its upcoming installation. Once the system was designed and delivered, MDT maintenance staff became concerned about the complexity and technical expertise that may be needed to install the system. This was understandable, considering the change in system complexity from the initial proposal to the final design. At this point WTI-MSU decided it best to contract the installation.

There probably would have been more difficulties with installation and acceptance if the installation had not been contracted out. However, advertising, selecting and contracting with an installer did cause additional delays. Also, inspection responsibilities for the installation were not formalized. YNP, MDT, and WTI-MSU had all agreed to have staff available during the installation, but there were no formal punch lists, or formally designated responsibilities of inspection.

Generally the installation contractor performed well, but one aspect of the work was not inspected. The top of some of the concrete foundations was too high above the ground level; they did not meet the requirements for the clear zone (Figure 8.1). This required additional ground work and the transport of weed free soil to the site (Figure 8.2). In addition, some of the wooden poles were buried too deep in the ground; the holes in the poles that serve as a break away construction in case of a collision were buried (Figure 8.3). This was simply addressed by drilling additional holes in the wooden poles at the appropriate level (Figure 8.4).

After installation the system was faced with technological challenges, and the communication system did not meet the specifications listed in the contract. The required modifications (see Chapter 6) caused delays, but these delays became even longer when the vendor experienced financial difficulties and could not afford to address the problems appropriately between spring 2003 and summer 2004. Furthermore, the vendor tried to modify the radio system rather than replacing the radio system right away, which caused additional delays.

False positives caused by ice and snow, wet, high, and moving vegetation and signal reflection off large vehicles, and low temperatures required a range of hardware and software modifications. Remote access to the system proved to be important to be able to screen the detection data for unusual patterns that might indicate a problem. The system was originally designed to have remote access using a cell phone modem, but the signal reception proved unreliable. To address this problem the system was hooked up to a land-based phone line. However, parts from the phone company failed multiple times, and the noise on the phone line was too great for the modem to operate reliably. In Phase 2 of the project a satellite connection will be established for the system.



Figure 8.1: Some of the concrete foundations were in the clear zone and too high above the ground. This is the master station. The wooden post on the foreground is for the link to the land-based phone line. (Photo: Marcel Huijser, WTI-MSU)



Figure 8.2: The problem with some of the concrete foundations was addressed by putting weed free soil around the posts while not blocking the drainage from the road. (Photo: Marcel Huijser, WTI-MSU)



Figure 8.3: Some of the wooden poles were buried too deep. The stick indicates the upper of the three holes that serve as a break-away in case of a collision. All three holes should have been above the ground level. (Photo: Marcel Huijser, WTI-MSU)



Figure 8.4: The problem with some of the break-away constructions for the wooden poles was addressed by drilling new holes at the appropriate height above the ground level. (Photo: Marcel Huijser, WTI-MSU)

8.2.1.5 Support from project partners and investment in the project

YNP and MDT were the two main project partners. Both partners had significant concerns regarding the delays and technological challenges, which affected their level of support for the project on an ongoing basis. YNP was concerned with the dimensions of the system already and was worried about a change in the principal investigator of the project at WTI-MSU just before system installation. YNP also expected the animal detection system to be fully operational shortly after installation.

As mentioned before, MDT's reorganization of its maintenance division lowered the priority of the animal detection system project and its upcoming installation. After the animal detection system was installed and proved to have technological problems. When it became apparent that the communication system of the animal detection system also did not meet the specifications listed in the contract with the vendor, MDT did not accept ownership or responsibility for operation and maintenance. Therefore the draft management plan that had been developed was never put into effect. Because the situation regarding ownership and responsibility for operation and maintenance was unclear, YNP temporarily suspended WTI-MSU's research permit.

After the communication system had been replaced with a system that did meet the specifications listed in the contract, MDT was uncomfortable with the percentage of "unclear" detections. These detections did not necessarily classify as false positives as they could, at least partly, be related to real world events, including animal movements in the right-of-way. Nevertheless, MDT was uncomfortable with this detection data category. In addition, when the system proved to have blind spots (Figure 8.5) MDT required these blind spots to be addressed before accepting ownership and responsibility for operation and maintenance. The rationale was that even though the system detected most elk that crossed the road, and even though the system fully covered the road section where elk crossed most, the blind spots could lead to false negatives. Such false negatives could result in liability in case of an accident.

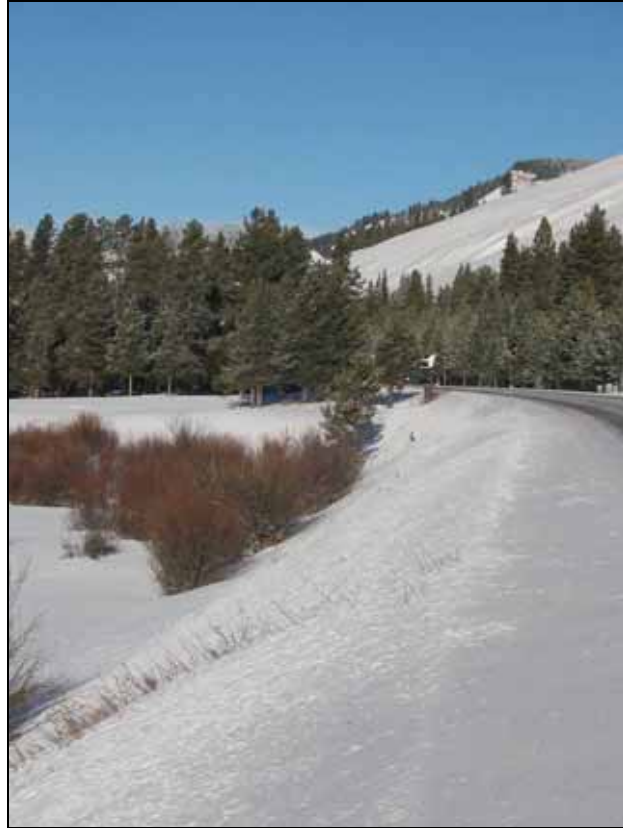

Figure 8.5: Curves and slopes caused the beam to shoot too high in some locations at the MT site, causing blind spots. Shown here is detection Zone 8 (see Figure 5.7 for exact location). (Photo: Marcel Huijser, WTI-MSU)

To summarize, the main project partners (YNP and MDT) had significant concerns prior to installation and these concerns were substantiated by technological difficulties, delays and an unknown number of complaints to YNP about the dimensions of the system. Furthermore, the main project partners' (YNP and MDT) expectations were geared more toward a typical construction project, with limited allowance for delays, problems, and imperfections that often occur in a research project. Not all of their requirements and expectations may have been realistic. Animal detection systems are based on relatively new technology that is used for a new application under sometimes extreme environmental conditions.

Perhaps WTI-MSU could have done more to emphasize the research character of the project, especially during the design and planning phase. Finally, because YNP did not have a financial investment in the project, YNP was able to request the removal of the animal detection system without experiencing a financial loss. Nonetheless, YNP eventually agreed to keep the system in place for Phase 2 of the project (until 31 August 2008) to allow for the evaluation of the effectiveness of the system.

8.2.2 Hwy 22/322, near Thompsontown, PA

The most important challenges encountered with the animal detection system and the project environment in Pennsylvania are listed below. The summary is based on the information in Appendix C. A chronological order is followed whenever possible.

8.2.2.1 Planning and design

The work for the site in Pennsylvania was initiated much later than at the Montana site. This was one of the main reasons why the system in Pennsylvania was not installed until May 2004. However, other important reasons for the delay in installation included a change in technology and very substantial delays in producing the engineering plan. The vendor was unable to meet the standards required for engineering plans, and the vendor was slow and incomplete when asked to provide technical specifications to a consulting firm who took over the responsibility to produce an engineering plan.

In addition, the vendor was unfamiliar with the laws and regulations for deployment in a roadside environment. Furthermore, the processes and procedures of the Pennsylvania Department of Transportation (PennDOT) for the agreement between the different project partners and permits proved to be much lengthier than anticipated. Additional delays occurred during winter when PennDOT had to prioritize road maintenance above system installation.

8.2.2.2 System deployment

After installation the system was faced with technological challenges. These included problems with the communication system, problem with the circuit boards, problems distinguishing between moving vehicles and deer (or human models), and integration problems between the animal detection part and the driver warning part of the animal detection system (see Chapter 2). Furthermore, communication with the vendor was a great concern, as there was no clear overview of the problems, the status of the problem identification process, the strategy to address these problems, or a time schedule. This was the main reason why the funders of the project (the 15 departments of transportation and the Federal Highway Administration) asked WTI-MSU to terminate the contract with the vendor and to ask the vendor to remove the system.

8.3 LESSONS LEARNED

The work involved in deploying the two experimental animal detection systems resulted in valuable experience related to the planning and design, installation, operation and maintenance, and evaluation of animal detection systems. The lessons learned are described below.

8.3.1 Planning and design

8.3.1.1 Projects and phases

Most animal detection systems are still largely experimental; they depend on a relatively new technology for a new application under sometimes extreme conditions (e.g., low temperatures, snow spray, flying debris from the road). In addition, the principles of how such a system detects animals approaching a road and key components of a system may be changed during the design process, even at the final stages. Therefore, both the planning and design and the installation phase are likely to take longer, sometimes much longer, than originally anticipated. In addition, it may take several months, sometimes years, for an animal detection system to become operational after it has been installed, as the circumstances encountered in a roadside environment may not have been fully taken into account during the design phase.

Different phases could perhaps be split into different projects to have better cost and time control as well as more realistic expectations about the outcome of the project. For example, all activities up until a system meets the basic contract requirements and becomes operational could form one project. A separate project would follow, which evaluates system reliability and system effectiveness and which documents the experiences with operation and maintenance. Further control can be obtained by having key elements of the system tested in a controlled access environment before installing the system in a roadside environment.

8.3.1.2 Roles and responsibilities

It is essential to clearly define the roles and responsibilities of the project partners. It is advisable to discuss every possible scenario, including potential technological problems, delays, actions and consequences if deadlines expire, and if and when the system should be removed. It is especially important to have clear qualitative or quantitative parameters for the transition of certain tasks or responsibilities between different project partners. If multiple suppliers are involved (e.g., separate vendors or organizations for different components of the animal detection system, driver warning signals, remote access or power), it is important to specify how the different components will interact and what type of connections are required on each end. System integration may require the expertise of an independent consultant (see also next section).

8.3.1.3 Coordination of planning, design and installation

This task was often underestimated or not explicitly recognized in animal detection system projects. Nevertheless, it is an important task and key for keeping the project on time and within budget. The planning, design and installation of animal detection systems should preferably be coordinated by a qualified consultant rather than a transportation agency or research institute. It is important, though, that the budgets are flexible enough to cope with potential technological challenges, changes in technology, and substantial delays. Furthermore, it is important to generate personal commitment and team effort among the project partners. It is also important that the project partners have a thorough

understanding of the risks of the project, and they need to agree on classifying the project as either a deployment or research project.

8.3.1.4 Selection of systems and vendors

There are many different animal detection systems and vendors (see e.g., Chapter 4 and Appendix E). It is a highly active field, and it is important to obtain the latest information on the experiences with the individual systems and their vendors before making a selection. Criteria for system reliability and other parameters could be developed to help with screening systems and vendors. Prequalification criteria could include the following:

- Previous and recent experience in the deployment of Intelligent Transportation System (ITS) equipment in a roadside environment;
- Experience with state and federal regulations regarding the deployment of ITS equipment in a roadside environment;
- Experience with hardware and software integration under environmental conditions that are challenging to high-tech equipment;
- Experience with an engineering approach to a design process and developing system acceptance criteria; and
- Experience with training project partners in the operation and maintenance of ITS equipment and software (partly based on PennDOT's ITS prequalification criteria for vendors).

In addition, it is important to critically analyze the system requirements for the site concerned. Several factors may dictate what types of technology may or may not be an option, e.g., soil, vegetation, road and right-of-way management, snow accumulation (Figure 8.6), fog, access to power or phone lines, safety requirements or landscape aesthetics. Furthermore, the responsible agency should verify whether vendors have the expertise and equipment to design and deliver all system components and products that are required, including surveying, roadside design, pole design (dimensions, foundations), and engineering plans with technical drawings. Manufacturers of animal detection systems typically have electronic and communications expertise but little or no experience with design and regulations on and around highways.

The responsible agency should verify the financial situation of the vendor firm. Vendors should also have the appropriate insurance for working in a roadside environment and should know and follow the appropriate safety procedures for working in a roadside environment.



Figure 8.6: Snow accumulation at the MT site. Snow accumulation may bury the sensors, potentially causing downtime for the system. (Photo: Marcel Huijser, WTI-MSU)

8.3.1.5 Contracts with vendors

The contracts should clearly define the basis of payments as associated with deliverables or completed milestones of the project. It is especially important to have clear and quantifiable criteria for system acceptance, perhaps in the form of a checklist (e.g., basic checks on the functioning of the system; a maximum percentage of false positives and false negatives; provision of spare parts). The majority of the payments should not be released until those criteria have been met. Because of potentially long delays before a system becomes operational, the warranty period should not start until the system has become operational, i.e., meets the designated criteria and is accepted by the transportation agency (see later).

8.3.1.6 Technical design

The components and specifications of an animal detection system, including the range of the sensors, should be extensively tested and verified in a laboratory or a non-roadside environment under a wide range of temperatures and other circumstances (e.g., simulated vegetation, traffic, precipitation, fog, and snow spray from snowplows).

The specifications of all components of the system should be checked and compared to the requirements listed in the contract. These include federal and state regulations, including FCC regulations for radio signals, and maximum heights and break-away construction for objects placed in the clear zone (including concrete foundations).

The circuit boards and other components and wire can be sensitive to moisture, and other equipment can be relatively heavy (e.g., batteries) or large (e.g., solar panels). The equipment, as well as the poles and foundations to which they may be attached, should be

designed to withstand their own weight, strong winds, heavy precipitation (including snow load and ice build-up), and in some cases, high humidity.

The site specific design for the location of posts and sensors should pay special attention to curves, slopes, rises, low areas and vegetation in the right-of way to avoid “blind spots” where the sensors cannot detect the target species. A thorough field review with the proper equipment is required for this.

All information, including product specifications and technical drawings, should be included in the engineering plan. The proposed site should be adequately surveyed to provide detailed data for equipment placement modeling.

In the case of a beam-break system, the maintenance of the proper beam height over the protected area is a critical factor. Final selection of equipment placement sites should be verified by an onsite electronic survey using a portable beam-break system. This intermediate step, taken prior to major construction, would validate the proposed layout, eliminating post-construction rework.

8.3.1.7 Power sources

Most animal detection systems are located in remote areas where 110 V or 220 V is not readily available. Even if such a power source is available it may be relatively expensive to bring power to the individual stations with the sensors. Edwards and Kelcey (2003) calculated that it would cost a minimum of \$52,893 for trenching and conduit for 2 times ½ mi (both sides of the road) for the PA site. This estimate was based on a cost of \$32.87/m (\$10/ft), not including electricity costs. Solar power can be a cost effective alternative. The total costs for solar power for the PA site were estimated at approximately \$7,500. Solar panels should be positioned such that shadows are taken into account, especially during winter when the sun is low on the horizon and shadows are long (Figure 8.7). Battery storage should also be designed to cope with long nights, dark days, and potential snow cover (Figure 8.8). Fuel cell technology may be an option for areas that do not receive enough sunlight (e.g., in the arctic or in deep canyons).



Figure 8.7: Care should be taken that solar panels are not placed in the shade of trees or other objects, including steep slopes. The angles of the sun should be calculated during winter, as daylight is scarce and the sun is low on the horizon. (Photo: Marcel Huijser, WTI-MSU)



Figure 8.8: Snow may temporarily cover the solar panels. The batteries should have enough power storage to accommodate for such events. (Photo: Marcel Huijser, WTI-MSU)

8.3.1.8 *Warning signs*

As more animal detection systems are installed and become operational, it becomes more important to standardize the warning signals and signs. However, there remains much to be learned about how different signs may contribute to the effectiveness of an animal detection system (see Chapter 3), and regulations for traffic signs sometimes differ between states. Note: Graphic warning signs (e.g., a black silhouette of an elk or a moose on a yellow background) are often stolen, as experienced at the MT site (see Section 8.3.3.5). This may be a reason to use text messages only, e.g., “wildlife crossing” on a yellow background. Furthermore, some states may need to modify the regulations regarding ITS signage to allow for signs that stimulate the drivers to use “extra” caution when the warning signs and signals are activated (see later). Finally, snow may temporarily obscure the signs (Figure 8.9).



Figure 8.9: Snow may temporarily cover warning signs and signals (Photo: Marcel Huijser, WTI-MSU)

8.3.1.9 *Management plan*

After the system is installed and becomes operational, a management plan should be in place. The plan describes who owns the system, who is responsible for operation and maintenance, and at what moment (i.e., date or condition of operation) that a transition in responsibility takes place. The plan must describe the procedures and list the contacts to report potential problems with the system. It should also specify who is responsible for

addressing the problems within a certain time frame. The responsible organization should also check basic functions of the system on a regular basis to ensure that the system is still functioning reliably.

8.3.1.10 *Parts and equipment*

Once delivered, an inventory of all components of an animal detection system, including poles, warning lights and signs, should be done.

8.3.1.11 *Media*

The media have a great interest in animal detection systems. They are concerned with the number of and increase in animal-vehicle collisions for various reasons: human safety, animal welfare, habitat connectivity, and population viability, especially for large mammal species. Since animal detection systems are located along roads, they are highly visible to the public, including journalists. It is recommended to send out a press release and a project fact sheet just before the installation of an animal detection system and prepare for questions from the media. However, if the animal detection system does not become operational shortly after it has been installed, negative articles may start to appear in the media; if so, appropriate responses should also be prepared for media inquiries resulting from this situation.

8.3.2 Installation

8.3.2.1 *Weather conditions*

It is advisable to schedule the installation work at a time of year when working conditions are relatively comfortable. For example, it is not advisable, sometimes even impossible, to dig holes and pour concrete for foundations when the ground is frozen or temperatures are well below freezing. Low temperatures also make it hard to work with electrical components, wires, and nuts and bolts, as it may require working with bare hands. It is also advisable not to plan for system installation just before a period when unfavorable weather conditions can be expected.

Planning, design and installation often take longer than planned and with only part of the installation work completed before it has to be suspended for the winter season or other adverse seasonal conditions. Weather deadlines can also cause problems with the coordination and timing of the different phases of the installation process (e.g., digging holes and pouring concrete foundations, painting of equipment, transport of equipment) (Figure 8.10). Finally, traffic control in low temperatures may be difficult for flaggers who must stand relatively still for long periods of time.



Figure 8.10: The elements can be hard on the equipment and the paint (Photo: Marcel Huijser, WTI-MSU)

8.3.2.2 Traffic control

Transportation agencies may provide traffic control. However, the work hours of employees of transportation agencies may differ from the employees of the vendor or installation contractor. In addition, transportation agencies may have to prioritize other tasks such as snow removal. If it is important to finish the installation as quickly as possible, it may be advisable to have the installation contractor be responsible for traffic control.

8.3.2.3 Communication

Animal detection systems may be installed at remote locations that have no cell phone coverage and no land based phones in the immediate area (Figure 8.11). Detailed planning to limit misunderstandings and miscommunication is recommended, as it may take some time to deal with problems and questions once they come up at the site.



Figure 8.11: Rhonda Stankavich (PennDOT) makes a call to the vendor at the PA site. Animal detection system projects typically require substantial coordination, sometimes from remote field locations. (Photo: Marcel Huijser, WTI-MSU)

8.3.2.4 *Engineering plan*

The actual specifications of an installed animal detection system are likely to be different from the anticipated specifications of the system. The engineering plans are likely to require an update to “as-builts,” including technical drawings and other specifications of the system.

8.3.2.5 *Signage*

Animal detection systems are unlikely to become operational immediately after installation. Therefore it is advisable to install the driver warning part of the system (e.g., flashing amber warning lights and warning signs) after the animal detection part of the system becomes operational (i.e., the system meets the requirements listed on a checklist for system acceptance).

8.3.2.6 *Post installation monitoring and modifications*

Since animal detection systems are likely to suffer from various problems after installation, it is advisable to have the vendor monitor the system at the site immediately after installation, perhaps for two to four weeks initially. The vendor must have appropriate tools, spare parts and other materials on site, as this effort is likely to include modifications and repairs. If problems are not identified or solved on site (Figure 8.12) further delays can occur.

The vendor should provide a “punch list” describing individual problems, including status of the problem identification, proposed strategy to address the problem, and a time schedule. This list should be updated on a regular basis, e.g., once every two weeks. It is important to continue coordination and to promote communication between the project partners during this phase. Vendors may not plan for the unexpected problems that commonly arise with these systems; therefore these requirements for post-implementation monitoring and troubleshooting should be specified in the Request for Proposals (RFP).



Figure 8.12: STS and MDT representatives at the MT site. After installation the system suffered from a range of technological challenges which required problem identification, problem solving and evaluation (Photo: Marcel Huijser, WTI-MSU).

8.3.2.7 System acceptance

System acceptance by a transportation agency should be based on whether the system meets the criteria of the contract and the criteria listed on a checklist (see Section 8.3.1.5), including a test for the basic functioning of the system and minimum requirements for system reliability (false positives and false negatives, including potential blind spots). Verifying whether the components used indeed meet state and federal regulations, e.g., FCC regulations, and safety regulations is recommended (e.g., break-away constructions if poles and equipment are placed in the clear zone). It is advisable to allow for a certain time period (e.g., at least 10 days, perhaps as long as three months or a year) to see if the system remains stable and functions reliably under a range of road and weather conditions.

8.3.3 Operation and maintenance

8.3.3.1 False positives and false negatives

False positives and false negatives may have a wide variety of causes (see Chapter 4). However, the systems at the MT and PA sites suffered especially from the following causes for false positives:

- faulty hardware;
- hardware that does not meet the requirements (e.g., temperature range);
- incorrect signal strength;
- inability of the software to distinguish between true and false detections;
- software errors;

- high, moving and wet vegetation;
- passing traffic;
- heavy snowfall with high moisture content;
- snow spray from snowplows and other vehicles;
- snow and ice accumulation in front of the sensors;
- snow accumulating on the ground and covering the sensors;
- vehicles turning on and off the road;
- vehicles parked in the right-of-way; and
- accumulating snow on the ground, blocking or bouncing signals.

Causes for false negatives included the following:

- incorrect location or height of sensors, leading to blind spots in curves or low areas in the right-of-way;
- faulty hardware;
- incorrect software definitions (settings) for valid detections;
- snow accumulation on ground leading to incorrect sensor height at high snow levels;
- sensors that are out of alignment (possibly due to expansion and shrinking of wooden poles with varying temperature and moisture contents);
- vandalism, or perhaps the rubbing against equipment by large animals, (e.g., elk or bears).

8.3.3.2 Maintenance

Operational systems should preferably have a management plan in place (see Section 8.3.1.9). This includes regular checking of the basic functions of the system to ensure that the system is still functioning reliably. This can be part of the tasks of local personnel from the transportation agency as well as local natural resource agency personnel. Remote access to the system to download and check detection data and potentially also data on battery voltage and the output of solar panels help simplify this effort. Nevertheless, regular visits to the site and accompanying budgets will remain necessary, for example, to check on the functioning of the flashing warning lights and the presence of the warning signs.

Other maintenance efforts may include a change in the management of the vegetation in the right-of-way (e.g., more frequent mowing or clipping), lower speed of snow plows to avoid physical damage to the equipment from snow and ice spray, and replacing faulty, damaged or missing equipment with spare parts. Telemetry data from the detection equipment can be used to determine the need for vegetation maintenance. The ability to quantify the overall system performance from logged data should be included to assist in evolving a maintenance plan which addresses current roadway conditions.

Snow cover on solar panels usually disappears quickly when the sun is out, even if the temperature remains well below freezing. Snow and ice should not be removed from the solar panels, as that may damage the solar panels in the process. Some of the solar panels

at the MT site have several cracks. This could be the result of snow and ice on the solar panels, but it is more likely the result of snow and ice or rocks from snowplows or other traffic. The damage has not led to any power problems to date, but this requires additional awareness and attention.

Snowstorms may also temporarily cover the flashing warning lights and warning signs with snow. However, it seems that flashing warning lights and the warning signs are usually visible again shortly after a snowstorm.

8.3.3.3 Remote access

Remote access to the detection data and other parameters (e.g., battery voltage, output of solar panels) is usually not essential to the functioning of an animal detection system; nevertheless, it may help save time and money as it allows vendors, maintenance and research personnel to check basic functions of the system. Depending on the system, hardware and software, remote access may also allow for the disconnection of certain sensors or stations if an isolated problem is suspected or observed that cannot be solved immediately. The remaining sensors will then remain in operation and will warn drivers when large animals approach the road in the sections with the active sensors or stations. In addition, remote access may allow for the connection or disconnection of the flashing warning signs and changing the time that the lights flash after the last detection has occurred.

Remote access can be obtained through a modem and a telephone connection (land-based, cellular or satellite) or radio signals if one is in the immediate area. Thorough testing for signal strength is required for a cellular telephone connection, as coverage can be poor or variable, especially in remote and rural areas. Data logging can be accomplished by allowing the animal detection equipment to periodically and autonomously download to an online database. Under this procedure, the detection equipment could produce reports whenever the data link (however implemented) is available. These data services are less expensive than “connection on demand” services and are readily provided by low earth orbiting satellites (LEOS) and cell phone systems. Two-way, real-time control of the detection equipment is probably not necessary.

8.3.3.4 Signage

It should never be assumed that animal detection systems detect all large animals that approach the road. False negatives should be kept to an absolute minimum, but depending on the terrain, weather conditions, location of the sensors, potential equipment failure and weather conditions, the system may have blind spots or may be faced with very challenging conditions at certain times. Therefore the warning signs should inform drivers that they should pay “extra attention” to the potential presence of large animals on or near the road when the flashing warning lights are activated rather than suggest that there are no large animals present when the warning lights are not activated (see *Katz, et al. 2003*). However, regulations for the wording on warning signs vary between states.

8.3.3.5 *Accidents, vandalism and theft*

Vandalism and theft have not been a major problem at the MT or PA sites. Only one solar panel and an elk silhouette sign were stolen at the MT site. Anti-theft screws, nuts and bolts may help reduce this problem, but replacing the elk silhouette signs with a text message (see Section 8.3.1.8) may be more effective. In addition, wires were broken and a sensor was pushed out of alignment, apparently as a result of a person attempting to climb a pole.

Accidents occurred at the MT site, mostly because of slippery road conditions (snow and ice). Based on car tracks in the snow and broken car parts observed during regular visits, at least seven vehicles went off the road on the 1,609 m (1 mi) long section with the animal detection system in the winter of 2003-2004. None of these vehicles hit any of the posts or the equipment placed in the right-of-way. In January 2003 a vehicle went off the road and did cause approximately \$2,000 worth of damage to a sensor, but the vehicle missed the post. The number of vehicles that lose control and go off the road illustrates an important point: a functional animal detection system may reduce the number of animal-vehicle collisions, but if the poles and equipment are placed in the clear zone in the right-of-way, they may constitute a safety hazard of their own, despite the presence of break-away systems.

8.3.3.6 *Landscape aesthetics*

Animal detection systems are usually rather large, and many people consider the poles and equipment unaesthetic, especially in areas that are valued for their scenery or low human impact. Furthermore, solar panels may reflect sunlight that, depending on the angle, can be a nuisance to drivers or people living in the area. Depending on the location of an animal detection system, landscape aesthetics may dictate the dimensions of a system and may be an important factor in the selection process. Aesthetics may also justify the relatively high expense for trenching and conduit to power the system with 110 V or 220 V rather than through solar panels.

Landscape aesthetics may become a driving factor in the miniaturization of animal detection systems. Reducing the power requirements of animal detection systems is especially important, as this has a direct impact on the size of the solar panels. Smaller solar panels may also require smaller posts and smaller foundations, as they weigh less and catch less wind. However, the posts are likely to remain relatively high (e.g., 1.8-3.0 m, 6-10 ft) for radio communication (antennas) and to reduce the risk of vandalism and theft of the solar panels.

9.0 COST-BENEFIT ANALYSES FOR ANIMAL DETECTION SYSTEMS

Author: Marcel P. Huijser
Western Transportation Institute, Montana State University
P.O. Box 174250, Bozeman, MT 59717-4250 e-mail: mhuijser@coe.montana.edu

9.1 INTRODUCTION

Like any other mitigation measure the benefits of animal detection systems must outweigh the costs if they are to be used on a wide scale (e.g., *Carter, et al. 2001; U.S. Department of Transportation 2003*). This chapter aims to calculate the benefits and the costs associated with the installation and use of animal detection systems. Only monetary values were included, but it is recognized that there are values associated with animal-vehicle collisions that may not readily translate into a monetary value or that one may consider inappropriate. Nevertheless, this chapter provides insight into whether animal detection systems could be considered a wise investment, at least from a monetary perspective.

9.2 METHODS

Potential benefits and costs associated with the installation and use of animal detection systems were calculated. For this analysis a hypothetical 1,609 m (1 mi) long road section that is straight and that allows for a minimum number of sensors to cover the road section was assumed. For example, the hypothetical road section has no features that may lead to an increase in the number of sensors needed to cover the road section (e.g., no access roads, slopes, vegetation, or other large objects). As a baseline it was assumed that no (other) mitigation measures were present prior to the installation and use of an animal detection system.

The parameters included for this analysis were vehicle repair costs, costs associated with human injuries and fatalities, the monetary value of the animal that was killed in the collision (based on hunting fees and other recreational values), the cost of disposal of the animal carcass, and the purchase, installation, operation, and maintenance of an animal detection system. The benefit and costs estimates were based on the literature, and historical figures were adjusted to provide a current estimate. However, official inflation indexes were not used and discounting was not applied. There may be substantial variation in the benefits and costs depending on the geographic region. Nevertheless, this analysis provides a first insight in the benefit-cost ratio of animal detection systems.

For this analysis WTI researchers chose to show the benefits and costs for a range of animal-vehicle collision numbers per 1,609 m (1 mi) road length and did not assume a fixed number of animal-vehicle collisions. However, researchers did distinguish between deer (*Odocoileus sp.*),

elk (*Cervus elaphus*) and moose (*Alces alces*) and provided separate estimates for these three species.

Seven animal detection systems in Switzerland resulted in an average of 82% reduction in collisions with large mammals (see Chapter 3; *Kistler 1998; Romer and Mosler-Berger 2003; Mosler-Berger and Romer 2003*). For this analysis, WTI researchers assumed an effectiveness rate (i.e., a reduction in animal-vehicle collisions) of 80% and a 10-year life span of an animal detection system. This is based on the fact that none of the seven systems in Switzerland were retired because of faulty or worn-out equipment and that the oldest one has now been in place for more than 12 years (1993-2005).

WTI researchers also assumed that the number of animal-vehicle collisions for the hypothetical 1,609 m (1 mi) long road section was known and accurate. However, the number of animal-vehicle collisions and animal carcasses may be underestimated; researchers have put this figure at 10.3% (*Tardif and Associates Inc. 2003*), 25% (*Sielecki 2004*), 50% (*Conover, et al. 1995; Tardif and Associates Inc. 2003; Huijser, et al. 2006b*), 77.5% (*Tardif and Associates Inc. 2003*), and 87.9% (*Tardif and Associates Inc. 2003*). These estimates for underreporting apply especially to deer, as this species is involved in the vast majority of all animal-vehicle or large wildlife-vehicle collisions in North America – 80% in Saskatchewan (*Tardif and Associates Inc. 2003*), and 81.4% in Maine (*Maine Department of Transportation 2001*).

Compared to deer-vehicle collisions, elk- and moose-vehicle collisions are more likely to result in a severe accident with substantial damage to the vehicle and potentially also human injuries and human fatalities. Therefore one may expect better reporting for elk and moose compared to deer. The data related to elk or moose, however, may be reported by emergency and rescue services (e.g., highway patrol) rather than road maintenance crews, because the carcass may have been removed before the road maintenance crews would come across it on their route the next day or several days later. Thus, when interpreting the results of WTI's benefit-cost analysis, the reader should bear in mind that the analysis is based on the actual number of animal-vehicle collisions.

9.3 RESULTS

9.3.1 Vehicle repair costs

In Nova Scotia, the minimum percentage of animal-vehicle collisions involving white-tailed deer (*Odocoileus virginianus*), which resulted in property damage was estimated at 90.2% – 3,524 collisions with property damage out of 3,905 collisions (*Tardif and Associates Inc. 2003*). In Utah, this percentage was estimated at 94% (*Romin and Bissonette 1996*). There were no similar data available for elk or moose. For this analysis the percentage of all collisions resulting in property damage was assumed to be 92% for deer, 100% for elk, and 100% for moose.

The property damage (repair costs for vehicles) has been estimated at \$1,200-\$1,881 for deer in Utah and Vermont, in 1992 (*Romin and Bissonette 1996*), \$1,577 on average for different regions in the United States in 1993 (*Conover, et al. 1995*), and \$1,700 for deer in the Midwest in 2002 and 2003. In New Mexico, the average vehicle repair cost of an elk-vehicle collision was

estimated at \$3,448, based on 7 collisions (*Biggs, et al. 2004*). Vehicle repair costs resulting from a collision with a moose in north central British Columbia can be as high as CAN \$25,000, but they averaged CAN \$5,150 in 1999 (see review in *Rea 2004*). In British Columbia, the average claim for an animal-vehicle collision was estimated at CAN \$ 2,200 in 2000 (*Sielecki 2004*) and CAN \$2,800 in 2001 (*Tardif and Associates Inc. 2003*). An average value of \$2,300 was reported for the United States in 2002 (*U.S. Department of Transportation 2002*). For this analysis it was assumed that the average vehicle repair costs as a result of animal-vehicle collisions were \$2,000 for deer, \$3,000 for elk, and \$4,000 for moose. Combined with the percentage chance that a collision indeed results in property damage (see earlier), the average vehicle repair costs per animal-vehicle collision was estimated at \$1,840 (deer), \$3,000 (elk), and \$4,000 (moose).

9.3.2 Human injuries

Animal-vehicle collisions can cause human injuries (*Conover, et al. 1995; Groot Bruinderink and Hazebroek 1996; Tardif and Associates Inc. 2003; Conn, et al. 2004; Pynn and Pynn 2004*). In the United States, animal-vehicle collisions were estimated to result in 26,647 human injuries per year (average for 2001-2002) (*Conn, et al. 2004*). An estimated 22,498 of these human injuries resulted from collisions with larger animals, mostly with deer (86.9%). An estimated 12.2% were the result of collisions with horses (*Equus sp.*) and bovines (*Bos sp.*). While elk, moose and bears (*Ursus sp.*) accounted for the remaining 0.8% (*Conn, et al. 2004*).

The percentage of white-tailed deer-vehicle collisions resulting in human injuries was estimated at 1.3% in Finland (*Haikonen and Summala 2001*); 3.8% in the U.S. Midwest (4,724 collisions with human injuries out of 125,608 collisions) (*Knapp, et al. 2004*); 4% in Ohio (review in *Schwabe, et al. 2002*), 7.7% in Ohio (10,997 collisions with human injuries out of 143,016 collisions) (*Schwabe, et al. 2002*); and 9.7% in Nova Scotia (378 collisions with human injuries out of 3,905 collisions) (*Tardif and Associates Inc. 2003*).

The percentage of moose-vehicle collisions resulting in human injuries was estimated at 9.9% in Finland (*Haikonen and Summala 2001*); 11.2% in Sweden (review in *Lavsund and Sandegren 1991*); 18% in Newfoundland and Labrador (*Government of Newfoundland and Labrador 1997*); 21.8% in Newfoundland (363 collisions with human injuries out of 1,662 collisions) (*Tardif and Associates Inc. 2003*); 20% in rural Alaska (*Thomas 1995*); and 23% in Anchorage, Alaska (*Garrett and Conway 1999*). The ratio of moose-vehicle collisions to human injuries was estimated at 1:0.201 in Newfoundland (133 injuries from 661 collisions) (*Rathey and Turner 1991*) and 1:0.304 in Anchorage, Alaska (158 injuries from 519 collisions) (*Garrett and Conway 1999*). The ratios are higher than the percentages because more than one person may be present in a car, and multiple people may be injured as a result of one collision. For this analysis it was assumed that an animal-vehicle collision resulted in an average of 0.05 human injuries for deer, 0.10 human injuries for elk, and 0.20 human injuries for moose.

In Canada, the costs to society of a human injury as a result of a traffic accident was estimated at CAN \$97,000 (*Sielecki 2004*). In Alberta, the average net cost per human injury was estimated at CAN \$22,961 (hospitalized) and 3,466 (emergency room only) (*Jacobs et al. 2004*). In the United States, the cost of a human injury was estimated at \$170,000 for a severe injury and \$33,000 for a minor injury (*Schwabe, et al. 2002*); it was also estimated at \$206,000 for an

incapacitating injury, \$41,000 for an evidential injury, and \$22,000 for a possible injury (*U.S. Department of Transportation 2002*). In New Mexico, Biggs, et al. (2004) assumed an average cost of \$10,000 per human injury, including medical expenses and lost work time. In Ohio, Wu (1998) estimated these costs at \$34,000 for 1996. For this analysis it was assumed that a human injury as a result of an animal-vehicle collision averaged \$50,000 in medical costs and loss of work time. This results in an average cost for human injuries of \$2,500 (deer), \$5,000 (elk) and \$10,000 (moose) per animal-vehicle collision.

9.3.3 Human fatalities

Animal-vehicle collisions can cause human fatalities (*Conover, et al. 1995; Groot Bruinderink and Hazebroek 1996; Tardif and Associates Inc. 2003; Williams and Wells 2004*). A study that used data from nine states (Colorado, Georgia, Minnesota, Missouri, North Carolina, Ohio, Pennsylvania, South Carolina and Wisconsin) found that 77% of all animal-vehicle accidents with human fatalities involved deer (*Williams and Wells 2004*).

The percentage of white-tailed deer-vehicle collisions resulting in human fatalities was estimated at 0.009% in Ohio (14 collisions with human fatalities from 143,016 collisions) (*Schwabe, et al. 2002*); 0.029% in North America (review in *Schwabe, et al. 2002*); 0.03% in the U.S. Midwest (33 collisions with human fatalities from 125,608 collisions) (*Knapp, et al. 2004*); and 0.05% in Nova Scotia (2 collisions with human fatalities from 3905 collisions) (*Tardif and Associates Inc. 2003*).

The percentage of moose-vehicle collisions resulting in human fatalities was estimated at 0% in Anchorage, Alaska (0 fatalities from 519 collisions) (*Garrett and Conway 1999*); 0.36% in Newfoundland (6 collisions with human fatalities from 1662 collisions) (*Tardif and Associates Inc. 2003*), 0.45% in Newfoundland (3 fatalities from 661 collisions) (*Rathey and Turner 1991*); 0.5% in Sweden (review in *Lavsund and Sandegren 1991*); and 0.50% in rural Alaska (*Thomas 1995*). For this analysis it was assumed that an animal-vehicle collisions resulted in an average of 0.0005 (deer), 0.0020 (elk) and 0.0040 (moose) human fatalities.

In the United States the monetary loss of a human fatality has been estimated at \$1,500,000 (*Romin and Bissonette 1996*), \$2,393,000 (*Schwabe, et al. 2002*), and \$2,981,000 (*U.S. Department of Transportation 2002*). In Canada, the costs to society of a human fatality as a result of a traffic accident was estimated at CAN \$4,170,000 (*Sielecki 2004*). In a review study Trawén, et al. (2002) calculated the costs of a fatal casualty of road accidents in a wide range of countries, including the United States. They calculated the costs at about \$ 3,600,000 for the United States in 1999. For this analysis it was assumed that a human fatality as a result of an animal-vehicle collision averaged \$3,000,000 in costs to society. This results in an average cost for human fatalities of \$1,500 (deer), \$6,000 (elk) and \$12,000 (moose) per animal-vehicle collision.

9.3.4 Monetary value of animals

Animals usually die immediately or shortly after having been hit by a vehicle. In Michigan, Allen and McCullough (1976) estimated that a minimum of 91.5% of all white-tailed deer that

were hit by a vehicle died at the scene or later. For this analysis we assumed that an animal-vehicle collision always resulted in the eventual death of the animal, regardless of the species.

The monetary value of wildlife has many different components, including license fees, costs associated with hunting (materials, transport, lodging, meals), and recreational wildlife viewing. Hunting license fees in British Columbia were CAN \$ 15-125 for deer, CAN \$ 25-200 for elk, and CAN \$ 25-200 for moose, for residents and non-residents respectively (Sielecki 2004). The net return to the economy of British Columbia from hunting was estimated at CAN \$ 1,270-7,450 for deer, CAN \$ 3,250-3,290 for elk, and CAN \$ 1,250-1,680 for moose (Sielecki 2004). The total net return to the economy of British Columbia from recreational wildlife viewing was estimated at CAN \$174,000,000 per year (Sielecki 2004).

There were an estimated 681,000 individuals of large mammals present in British Columbia, including black bears (*Ursus americanus*), grizzly bears *Ursus arctos*), caribou (*Rangifer tarandus*), mule deer and black-tailed deer, white-tailed deer, elk, moose, and bighorn sheep (*Ovis canadensis*) (Sielecki 2004). This translates in an average value of CAN \$255 per large mammal for recreational wildlife viewing.

In New Mexico, the minimum estimated income to the state as a result of hunting was estimated at \$250 for deer and \$500 for elk, excluding hunter expenditures and associated economic benefits (Biggs, et al. 2004). In Utah, Romin and Bissonette (1996) estimated the economic value of a deer at \$1,313 in 1992. Bissonette and Hammer (2000) estimated the value of deer in Utah in 1999 at \$2,420. For this analysis we assumed that the total monetary value was \$2,000 (deer), \$3,000 (elk) and \$2,000 (moose).

9.3.5 Removal and disposal costs of deer carcasses

In Canada, the clean-up and carcass removal and disposal cost for animal carcasses were estimated at CAN \$ 100 for deer, CAN \$ 350 for elk, and \$350 for moose (Sielecki 2004). In Pennsylvania, the average for deer carcass removal and disposal in a certified facility was \$30.50 per deer for contractors and \$52.46 per deer for the Pennsylvania Department of Transportation in 2003-2004 (Jon Fleming, PennDOT, personal communication). For this analysis we assumed that the removal and disposal costs of animal carcasses to be \$50 (deer), \$100 (elk) and \$100 (moose).

9.3.6 Animal detection system costs

The costs of animal detection systems and their installation are shown in Chapter 4 (Table 4.1) as well as Table 9.1. The true costs are difficult to estimate, because many of the values shown apply to research and development costs, in-kind contributions, and/or different road lengths. WTI researchers set the planning costs for an animal detection system at \$50,000, the purchase cost for 1,609 m (1 mi) of road length at \$65,000, and the installation cost (including costs for eventual system removal) at \$50,000. An operation and maintenance budget of \$14,800 per year was assumed, including wages spent on management, checking on the status of the system, problem identification, and problem solving (\$10,000), replacement parts or repair parts (\$3,000), vegetation management (\$1,500), remote access to the system (\$300). Based on a 10-year life span (see Section 9.2) the yearly costs were estimated at \$31,300.

Table 9.1: Summary of costs of animal-vehicle collisions for deer, elk and moose

Description	Deer	Elk	Moose
Vehicle repair costs per collision	\$1,840	\$3,000	\$4,000
Human injuries per collision	\$2,500	\$5,000	\$10,000
Human fatalities per collision	\$1,500	\$6,000	\$12,000
Monetary value animal per collision	\$2,000	\$3,000	\$2,000
Carcass removal and disposal per collision	\$50	\$100	\$100
Animal detection system costs per year	\$31,300	\$31,300	\$31,300

9.3.7 Cost-benefit analyses

Based on the costs of animal-vehicle collisions, the costs for planning, purchase, installation, operation and maintenance of an animal detection system and the expected 80% reduction in animal vehicle collisions as a result of the installation of an animal detection system, a cost-benefit analysis for deer, elk and moose was conducted (Figure 9.1, Figure 9.2 and Figure 9.3).

The financial benefits of animal detection systems are greater than the costs with an average of at least 5 deer-, 3 elk- or 2 moose-vehicle collisions per mile road length per year.

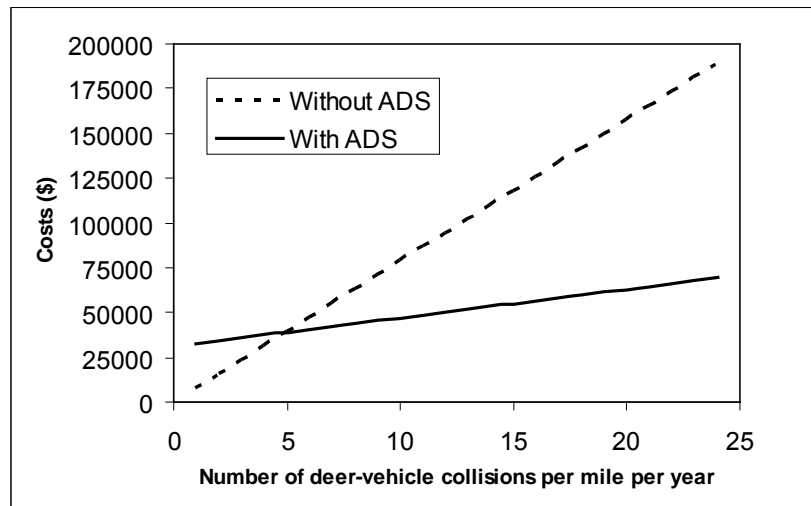

Figure 9.1: Costs of deer-vehicle collisions per mile per year with and without an animal detection system (ADS)

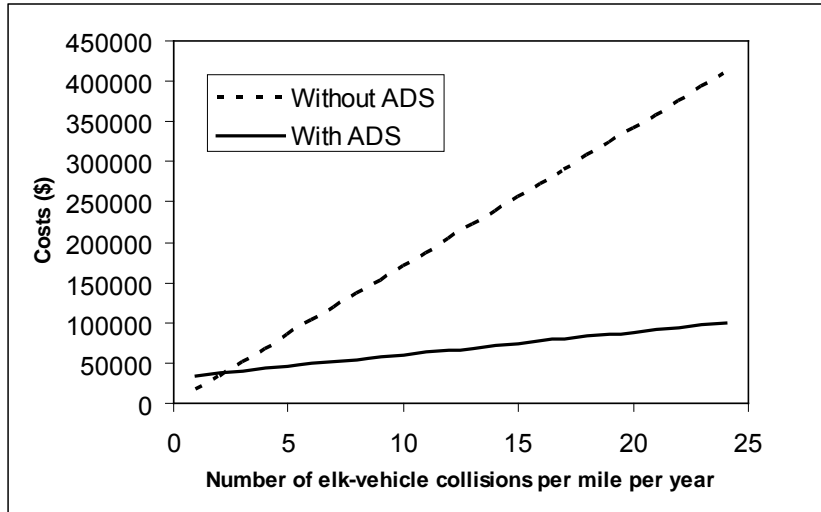

Figure 9.2: Costs of elk-vehicle collisions per mile per year with and without an animal detection system (ADS)

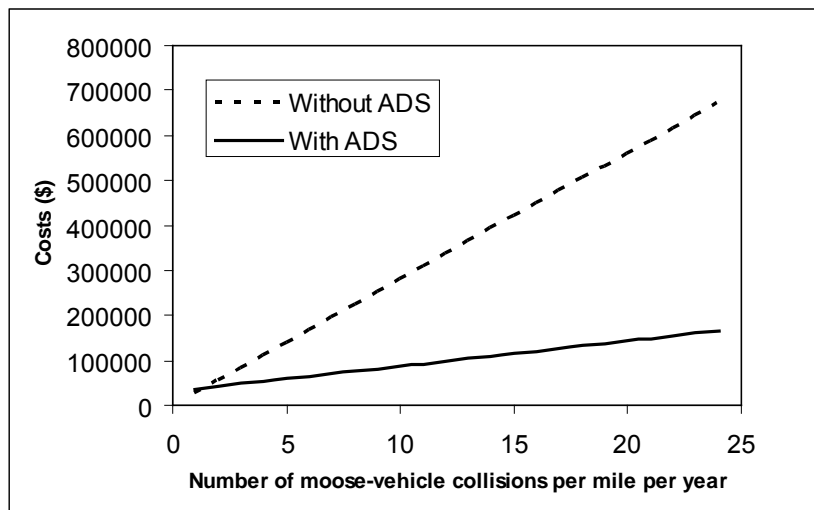

Figure 9.3: Costs of moose-vehicle collisions per mile per year with and without an animal detection system (ADS)

9.4 DISCUSSION AND CONCLUSION

WTI's cost-benefit analysis suggests that the benefits of animal detection systems are greater than the costs with an average of at least 5 deer-, 3 elk- or 2 moose-vehicle collisions per mile road length per year. This suggests that animal-detection systems have the potential to be applied on a wide scale. However, animal detection systems are typically paid for by transportation agencies, while the majority of the monetary benefits relate to lower costs for insurance

companies. Thus, while animal detection systems could be a wise investment for society as a whole, the costs and benefits are paid for and received by different groups in society.

Bear in mind that this analysis is based on a series of assumptions and estimates, which may need to be modified as more and better data become available. In addition, animal-vehicle collisions may also be mitigated by other mitigation measures, e.g., through wildlife fences in combination with wildlife crossings (*Clevenger, et al. 2001*). Animal detection systems may also be combined with these other mitigation measures, potentially leading to shorter road lengths equipped with an animal detection system (see Chapter 10). The cost-effectiveness of the different measures or combinations thereof is likely to show a wide range of values; they may have different cost-benefit ratios, and this could be one of the arguments for or against certain mitigation measures compared to others.

10.0 POTENTIAL APPLICATIONS

Author: Marcel P. Huijser

Western Transportation Institute, Montana State University

P.O. Box 174250, Bozeman, MT 59717-4250 (e-mail: mhuijser@coe.montana.edu)

10.1 INTRODUCTION

Animal detection systems are usually installed at locations that have a history of animal-vehicle collisions, especially with large ungulates such as deer, elk or moose. The systems are primarily installed because of human safety and property damage concerns. Animal detection systems may also be installed at locations where a current or planned habitat linkage zone for large animals intersects with a road. Such a location may not have a history of animal-vehicle collisions, but transportation agencies or other stakeholders may choose to invest in avoiding or reducing the number collisions in the future. Depending on the species and regional situation, individuals that disperse over long distances can be essential to the colonization or re-colonization of isolated habitat patches and the long term survival probability of the species in a particular region. These individuals are particularly valuable from a conservation perspective, and this may justify animal detection systems or other mitigation measures, regardless of how many animal-vehicle collisions have occurred in the past.

This chapter discusses the potential applications for animal detection systems and the advantages and disadvantages of these systems compared to other mitigation measures such as wildlife crossing structures and wildlife fencing. This chapter is partly based on Huijser (2003).

10.2 POTENTIAL APPLICATIONS

Animal detection systems can be installed over relatively great road lengths (Figure 10.1.a). The systems can also be combined with limited or extensive wildlife fencing (Figure 10.1.b-f) and with other mitigation measures such as wildlife crossing structures (i.e., underpasses or overpasses) (Figure 10.1.e-f and Figure 10.2). The following paragraphs discuss the advantages and disadvantages of animal detection systems compared to wildlife crossing structures and combinations with limited or extensive wildlife fencing.

Figure 10.1 features a schematic representation of potential applications of animal detection systems along a road:

- a. System installed over a relatively long road section without wildlife fencing;
- b. System installed in a gap with extensive wildlife fences on either side;
- c. System installed in a gap with limited wildlife fences on either side, aimed at funneling the animals towards the road section with the system;
- d. System installed at the end of extensive wildlife fencing;

- e. System installed at the end of extensive wildlife fencing, aimed at funneling the animals through an underpass; and
- f. System installed along a low volume road that parallels a high volume road with an underpass.

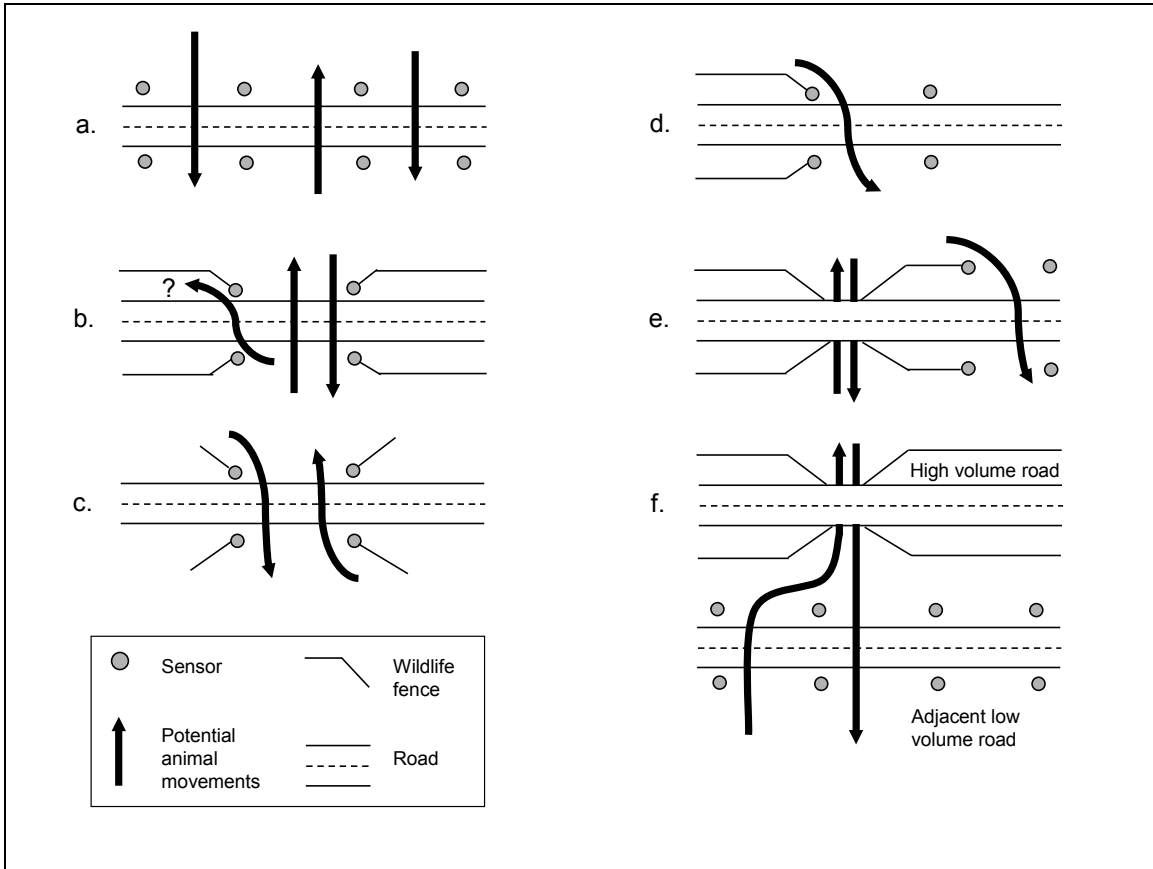

Figure 10.1: Potential applications of animal detection systems



Figure 10.2: Wildlife crossing structures are often combined with wildlife fencing to guide the animals towards the crossing structure. Since some animals may walk the other way and cross the road where the fence ends, an animal detection system may be applied also. (Photo: Marcel Huijser, WTI-MSU)

10.2.1 Animal detection systems versus wildlife crossing structures

Wildlife crossing structures (i.e., underpasses or overpasses) are usually limited in number and width. Relatively wide overpasses are rarely wider than about 50 m (54.5 yd) (Pfister, *et al.* 2002). Underpasses can be much wider, but this is usually related to the nature of the terrain (e.g., the width of a canyon or river) rather than to wildlife needs. As a consequence, wildlife crossing structures only provide wildlife with safe crossing opportunities over relatively short road lengths at a limited number of locations. Animal detection systems however, can be installed over several kilometers (miles) of road length or more (see e.g., Chapter 4). Thus animal detection systems have the potential to provide wildlife with safe crossing opportunities anywhere along the mitigated road section. This allows animals to continue to use their existing approaches to the road or to change them over time. However, if animal detection systems are installed along road sections that are only several tens or hundreds of meters (yards) long, they lose this important advantage over wildlife crossing structures.

Animal detection systems only detect large animals (e.g., deer, elk and/or moose). Relatively small animals are not detected, and drivers are not warned about their presence on or near the road. Some species avoid dry open areas or pavement and may be deterred from crossing a road altogether. Wildlife crossing structures have the potential to provide cover (e.g., vegetation, including living trees, tree stumps) and natural substrate (e.g., sand, water) and allow safe crossing for a relatively wide array of species. In addition, some types of animal detection

systems are only active in the dark and animals that cross during the daylight may not be protected.

Animal detection systems usually require the presence of poles and equipment in the right of way, sometimes even in the clear zone. While animal detection systems have the potential to avoid or reduce the number of animal-vehicle collisions, the poles and equipment can be a safety hazard of their own, despite the presence of break-away systems (Figure 10.3). In addition, animal detection systems allow large animals to cross the road at grade. While the number of animal-vehicle collisions may be substantially reduced, animal detection systems will never be able to entirely eliminate animal-vehicle collisions (see Chapter 3). Wildlife crossing structures separate animals and traffic and are therefore safer by definition.



Figure 10.3: Animal detections may reduce or prevent animal-vehicle collisions, but the poles and equipment in the right-of-way form a hazard of their own. Here a car went off the road at the MT site and just missed the pole. However, the damage to one of the sensors was about \$2000. (Photo: Jason Norman, MDT)

Finally, animal detection systems can be installed without major road construction or traffic control for long periods. They are also likely to be less expensive than wildlife crossing structures, especially once they are mass produced. However, wildlife crossing structures are likely to have greater longevity; they are typically more robust (less likely to fail or require constant checking and maintenance), and their long term maintenance may be less expensive.

10.2.2 Wildlife fencing versus no wildlife fencing

Animal detections systems may be combined with wildlife fencing (Figure 10.1 and Figure 10.4). Extensive or limited wildlife fencing on both road sides and on either side of an animal detection system may help funnel the animals towards a road section with an animal detection system (Figure 10.1.b and c). This increases the length of the mitigated road section, and it may

allow for fewer sensors and lower costs. Fence installation and maintenance costs, however, may be high. (e.g., *Clevenger, et al. 2002*)



Figure 10.4: Wildlife fences guide large animals towards the crossing area with the animal detection system. Long fence sections should have jump-outs however, to provide an escape for animals that might end up in between the fences in the right-of-way. (Photo: Bethanie Walder)

Wildlife fencing that is contiguous over long distances with only a few gaps, with or without an animal detection system (e.g., *Lehnert and Bissonette 1997*), results in few crossing opportunities for large animals. This reduces the connectivity between populations on either side of the road, and long distance dispersers that may be unfamiliar with the area and the location of the gaps may be particularly affected. Therefore it is essential to relate the location and number of the gaps to the desired level of connectivity. Wildlife fences can also lead to other problems. For example, animals may wander off in the right-of-way and become trapped in the road corridor in between the wildlife fences (Figure 10.1.b). One-way exits such as jump-outs can help address this potential problem (*Bissonette and Hammer 2000*).

Despite the problems associated with animal detection systems along short road sections with limited or extensive wildlife fencing, a limited number of crossing areas may be more effective in reducing animal-vehicle collisions than animal detection systems on long road sections where animals can cross anywhere. Animal detection systems on short road sections known for their high probability of crossing animals may cause drivers to be more alert and reduce their speed further than systems on long road sections that have more diffuse and less predictable animal movements across the road.

Animal detection systems may also be deployed at fence ends (Figure 10.1.d and e) or along a low volume road that parallels a high volume road (Figure 10.1.f). Here the wildlife fencing or other mitigation measures (e.g., a wildlife underpass or overpass) are the main mitigation

measure, not the animal detection systems. Animal detection systems deployed at fence ends are to reduce or avoid a concentration of animal-vehicle collisions at fence ends, as animals may follow the fence and cross where the fence ends (e.g., *Dodd, et al. 2004*). Animal detection systems along a low volume road that parallels a high volume road with wildlife fencing and wildlife crossing structures (i.e., underpasses or overpasses) reduce or avoid collisions with animals that have just passed or are about to pass through the crossing structure.

11.0 CONCLUSIONS, RECOMMENDATIONS AND FUTURE RESEARCH

Author: Marcel P. Huijser
Western Transportation Institute, Montana State University
P.O. Box 174250, Bozeman, MT 59717-4250 (e-mail: mhuijser@coe.montana.edu)

11.1 CONCLUSIONS AND RECOMMENDATIONS

In order to be effective, animal detection systems must detect large animals reliably (see Chapter 2). However, most experimental animal detection systems suffer from a variety of technological difficulties following installation, and major delays in obtaining an operational system are common (see Chapter 4 and 6). Animal detection systems typically show an abundance of false positives and false negatives and experience substantial downtime. A limited number of vendors and system integrators have successfully addressed these difficulties, and this has resulted in reliable and effective animal detection systems (see Chapter 3, 4 and 7). In other cases vendors and system integrators have not succeeded in producing a reliable system yet, or they have abandoned the project altogether.

Data on the effectiveness of animal detection systems are relatively scarce and sometimes inconsistent. Most of these data relate to the effect of the warning signals and warning signs on vehicle speed. Data with regard to the most important parameter, the number of animal-vehicle collisions, are even scarcer. There are multiple reasons for this:

- It is hard to collect animal-vehicle collision data that qualify as monitoring data (constant searching and reporting effort);
- Monitoring data may not have been collected before the system was installed;
- It takes a long time to collect sufficient data, because the road sections over which animal detection systems are installed are often relatively short, and the number of animal vehicle collisions is often relatively low and variable; and
- The data are rarely analyzed and published.

Despite the scarceness of data on system effectiveness, there is substantial evidence that, depending on the type of warning signals and road and weather conditions, drivers do reduce their vehicle speeds when confronted with activated warning signals (*Kistler 1998; Muurinen and Ristola 1999; Gordon and Anderson 2002; Gordon, et al. 2004; Kinley, et al. 2003; Hammond and Wade 2004*). Activated warning signals and signs may also make drivers more alert, resulting in a potential reduction in stopping distance (see Chapter 3). Increased driver alertness and lower vehicle speed can result in a substantial reduction of animal-vehicle

collisions. Area cover infra-red animal detection systems in Switzerland have reduced the number of collisions with large animals by about 80% (*Kistler 1998; Romer and Mosler-Berger 2003; Mosler-Berger and Romer 2003*; see also chapter 3). Other systems that seem to be reliable and/or effective are as follows:

- The area cover infra-red system from Finland (*Muurinen and Ristola 1999*);
- The geophone system from Wyoming, USA (*Gordon, et al. 2001; Gordon and Anderson 2002*);
- The elk radio collar system from Washington State, USA (Shelly Ament, Washington Department of Fish and Wildlife, personal communication); and
- The break-the-beam radio signal systems in Montana and Indiana (this report; see chapter 7).

However, data on system reliability and system effectiveness of the Finnish system and the elk radio collar system are anecdotal and neither documented nor published, at least at this time. The geophone system appears to be extremely reliable, but the system was not evaluated with regard to a potential reduction in animal-vehicle collisions. Finally the break-the-beam systems in Montana and Indiana seem reliable, but there are no data available yet with regard to system effectiveness.

If a transportation agency is interested in deploying an animal detection system, the following steps are recommended:

1. Define the problem to be solved (e.g., target species, parameters of effectiveness) and identify the requirements of the transportation agency (e.g., desired level of effectiveness, maximum maintenance effort) and the site specific conditions and requirements (e.g., slopes, curves, vegetation, minimum distance from the road, vegetation management restrictions) (see also Chapter 8). Ideally this should be an outcome of a regional prioritization identifying current animal-vehicle collision hot spots or habitat linkage zones and potential future changes to animal movement due to changes in land use.
2. Obtain a current overview of all known mitigation measures that may address the problem, that meet the requirements of the transportation agency, and that match the site specific conditions and requirements. Determine whether an animal detection system is indeed the most appropriate mitigation measure. While animal detection systems can be applied as a standalone mitigation measure, animal detection systems can also be used in combination with other mitigation measures such as wildlife fencing and wildlife crossing structures (Chapter 10).
3. Obtain a current overview of all known animal detection systems, their vendors, and the experiences with system reliability, system effectiveness and other aspects of operation and maintenance, as well as other lessons learned (see Chapters 3, 4, 7 and 8).
4. Select a system that meets the requirements of the transportation agency and that matches the site specific conditions and requirements. Not all reliable or effective systems may be suitable. Ideally, systems should meet minimum standards for system reliability. Such

standards, however, have not been established at this time; therefore, no system has yet been tested with regard to such minimum requirements. If no reliability data is available, consider a two-phased contract with the vendor. The first phase would entail a beta test of the system in a smaller temporary installation to determine system reliability prior to a more permanent roadside installation in the second phase.

5. Make a realistic risk assessment for potential delays, technological challenges, the financial situation of a vendor, and political support for the project. If the outcome of the assessment is not acceptable, consider alternative mitigation measures.
6. Take the lessons learned from this project into account (see Chapter 8) when preparing project descriptions, contracts and other agreements with vendors, installation contractors, researchers and other project partners.
7. Prepare for technological difficulties and substantial delays following the installation of an animal detection system. It may take many months, sometimes years, before an animal detection system becomes operational. Even systems that are initially successful will fail without proper monitoring and maintenance. Also prepare for potential abandonment of the project and system removal.
8. Document and publish the experiences with the project, including lessons learned during design and planning, installation, and operation and maintenance, regardless of whether the project results in a reliable or effective system. This provides essential guidance for similar projects in the future.
9. Document and publish data on system reliability and system effectiveness, regardless of whether the project results in a reliable or effective system. This will allow transportation agencies to compare the effectiveness of animal detection systems to other mitigation measures and to select the most reliable and effective animal detection systems.

11.2 FUTURE RESEARCH

In order to be able to select reliable and effective animal detection systems, transportation planners must be able to compare the performance parameters of the systems. For example, minimum standards have to be set for system reliability. However, not all available or operational animal detection systems (Chapter 4) have been properly evaluated with respect to system reliability, or they were evaluated with respect to slightly different parameters, using different methods under different circumstances.

Guidance is needed for the further development of animal detection systems. This includes a high level concept of operations that shows how animal detection systems may work in the future. It also specifies how animal detection systems may communicate with drivers, cars, employees from transportation agencies, and researchers, and how they may be integrated with national Intelligent Transportation Systems (ITS) architecture and standards.

Once the animal detection part of an animal detection system functions reliably, the driver warning part of the system needs to inform the drivers about the potential animal presence on or

near the road. The type of warning signs and signals and the distances between the warning signals are likely to influence driver awareness and driver response (see Chapter 3). Questionnaires and driving simulator studies can help identify the most effective warning signs, signals and distance, and will help develop standards.

Future research on animal detection systems should address the following issues:

High level concept of operations. Develop a high level concept of operations for animal detection systems to show how the systems may work in the future and to provide guidance to the further development of animal detection systems. This question is currently being addressed in a controlled access environment in Lewistown, Montana (*Huijser and McGowen 2004*).

Smaller and less obtrusive animal detection systems. This is not only required to address landscape aesthetics concerns; smaller systems also reduce the hazard for people in vehicles that run off the road. See Chapter 6 for ideas for a second generation system by Sensor Technologies and Systems.

National Intelligent Transportation Systems (ITS) architecture and standards. Help develop animal detection systems that are integrated into national ITS architecture and standards. This should provide guidance for the further development of animal detection systems. This question is currently being addressed in a controlled access environment in Lewistown, Montana (*Huijser and McGowen 2004*).

Comparable reliability data. System reliability data from different systems obtained under similar circumstances at a controlled access environment should allow employees from transportation agencies to select the most reliable systems. This question is currently being addressed in a controlled access environment in Lewistown, Montana (*Huijser and McGowen 2004*).

Minimum standards. Minimum standards for the reliability of animal detection systems should allow employees from transportation agencies to select systems that meet certain minimum standards for system reliability. Such a set of standards also provides guidance to vendors and system integrators for the future development of animal detection systems. This question is currently being addressed in a controlled access environment in Lewistown, Montana (*Huijser and McGowen 2004*).

Warning signs and signals. The most effective warning signs and signals, including appropriate distance between warning signs and signals, need to be identified, and standards need to be established. This question can be addressed through questionnaires and driving simulator studies.

Management experiences. Collect, analyze and interpret data on the experiences with planning and design, installation, operation and maintenance, and evaluation of animal detection systems. This question is partly addressed in a current study in a controlled access environment in Lewistown, Montana (*Huijser and McGowen 2004*). However, data from other projects are needed, especially from those that deal with system deployment in a roadside environment. This requires maintaining a network of researchers, vendors and managers involved with animal detection system projects throughout the world, and interviewing them.

Share data on system effectiveness. Collect, analyze and interpret data on system effectiveness from systems that have been deployed in a roadside environment and that are operating reliably. This task requires maintaining a network of researchers, vendors and managers involved with animal detection system projects throughout the world, and promoting data collection and the sharing of these data.

12.0 REFERENCES

Allen, R.E. and D.R. McCullough. 1976. Deer-car accidents in southern Michigan. *Journal of Wildlife Management* 40: 317-325.

Anonymous. 1994a. Ausland zeigt Interesse an der in ihrer Art nur an der Sernftalstrasse zu findenden Wildwarnanlage: Schlagendes Argument dafür: kein einziger Unfall seit der Inbetriebnahme mehr! 13 October 1994. Friedolin, Switzerland.

Anonymous. 1994b. Holländische Delegation interessiert sich für Bündner Wildwarn-Pilotanlage. 7 October 1994. *Bündner Zeitung* (BZ) (current name of newspaper is *Die Südostschweiz*). Südostschweiz Presse AG. Chur, Switzerland.

Anonymous. 1996. Wildwarnanlagen bei Flims und Trin. Tempolimit könnte Unfallgefahr drastisch vermindern. 15 November 1996. *Bündner Zeitung* (BZ) (current name of newspaper is *Die Südostschweiz*). Südostschweiz Presse AG. Chur, Switzerland.

Anonymous. 2002. Infodienst Wildbiologie and Oekologie. Jahresbericht 2001. Zürich, Switzerland.

Arizona Court of Appeals. 2004. *Booth v. State of Arizona*. 2 CA-CV 2003-0097. Court of Appeals, State of Arizona, Division Two. Opinion Filed: 30 January 2004. Available from the internet. URL: <http://www.apltwo.ct.state.az.us/Decisions/CV20030097Opinion.pdf>. Accessed 16 February 2006.

Bendix Commercial Vehicle Systems. 2002. Bendix Xvision system service data. Available from the internet. URL: <http://www.bendix.com/downloads/195160.pdf>. Accessed 9 September 2003.

Biggs, J., S. Sherwood, S. Michalak, L. Hansen and C. Bare. 2004. Animal-related vehicle accidents at the Los Alamos National Laboratory, New Mexico. *The Southwestern Naturalist* 49(3):384-394.

Bissonette, J.A. and M. Hammer. 2000. *Effectiveness of earthen return ramps in reducing big game highway mortality in Utah*. Final report. Utah Cooperative Fish and Wildlife Research Unit. UTCFWRU Report Series 2000 (1): 1-29.

Bushman, R., J. Vinek and E. McCaig. 2001. Development of a warning system for the reduction of animal/vehicle collisions. Rural Advanced Technology and Transportation Systems 2001 International Conference. 25-28 August 2001. Burlington, VT, USA.

Carey, M. 2002. Addressing wildlife mortality on highways in Washington. In *2003 Proceedings of the International Conference on Ecology and Transportation*. 24-28 September 2001. Keystone, CO, USA. pp. 605-610.

Carter, D.W., L. Perruso and D.J. Lee. 2001. *Full cost accounting in environmental decision-making*. EDIS document FE 310, Department of Food and Resource Economics, Florida Cooperative Extension Service, Institute of Food and Agricultural Sciences, University of Florida, Gainesville, FL, USA.

Chagrin Valley Times. 2005. Experts explain ways for non-lethal culling. *Chagrin Valley Times*. 27 October 2005.

Cheu, R. and S. Ritchie. 1995. Automated detection of lane-blocking freeway incidents using artificial neural networks. *Transportation Research Part C: Emerging Technologies* 3(6): 371-388.

Clevenger, A.P., B. Chruszcz and K. Gunson. 2001. Highway mitigation fencing reduces wildlife-vehicle collisions. *Wildlife Society Bulletin* 29: 646-653.

Clevenger, A.P., B. Chruszcz, K. Gunson and J. Wierzchowski. 2002. *Roads and wildlife in the Canadian Rocky Mountain Parks – Movements, mortality and mitigation*. Final report to Parks Canada. Banff, Alberta, Canada.

Coltharp, B. 2005. Wild animal crash mitigation. CDOT Research Newsletter. 2005-3: 1.

Conn, J.M., J.L. Anest and A. Dellinger. 2004. Nonfatal motor-vehicle animal crash-related injuries – United States, 2001–2002. *Journal of Safety Research* 35: 571– 574.

Conover, M.R. 1997. Monetary and intangible valuation of deer in the United States. *Wildlife Society Bulletin* 25: 298-305.

Conover, M.R., W.C. Pitt, K.K. Kessler, T.J. DuBow and W.A. Sanborn. 1995. Review of human injuries, illnesses, and economic losses caused by wildlife in the United States. *Wildlife Society Bulletin* 23: 407-414.

Cox, K.M., B.G. Hansen and J.K. Grant. 2005. Wildlife Detection and Advisory System, Pinedale, Wyoming. Paper presented at ITE District 6 2005 Annual Meeting. 10-13 July 2005. Kalispell, MT, USA.

Dodd, N., J. Gagnon and R. Schweinsburg. 2003. Evaluation of measures to minimize wildlife-vehicle collisions and maintain wildlife permeability across highways. Quarterly Progress Report 6. Arizona Game and Fish Department, Research Branch. Phoenix, AZ, USA.

Dodd, N., J. Gagnon and R. Schweinsburg. 2004. Evaluation of measures to minimize wildlife-vehicle collisions and maintain wildlife permeability across highways. Quarterly Progress Report 10. July 5 2004. Arizona Game and Fish Department, Research Branch. Pinetop, AZ, USA.

Edwards and Kelcey, Inc. 2003. A review of the proposed animal vehicle crash mitigation using advanced technology (draft). Along SR 0022, Delaware Township, Juniata County, PA, in PENNDOT engineering district 2-0. Edwards and Kelcey, Inc. Philadelphia, PA, USA.

- Eindhovens Dagblad. 2005. Waarschuwingssysteem voor project edelherten aan randen Weerterbos. Beveiliging tegen overstekend wild. Eindhovens Dagblad. 3 September 2005. The Netherlands.
- Farrell, J.E. 2002. Intelligent countermeasures in ungulate-vehicle collision mitigation. Professional paper. Montana State University. Bozeman, MT, USA.
- Farrell, J.E., L.R. Irby and P.T. McGowen. 2002. Strategies for ungulate-vehicle collision mitigation. *Intermountain Journal of Sciences* 8 (1): 1-18.
- Foster, M.L. and S.R. Humphrey. 1995. Use of highway underpasses by Florida panthers and other wildlife. *Wildlife Society Bulletin* 23: 95-100.
- Garrett, L.C. and G.A. Conway. 1999. Characteristics of moose-vehicle collisions in Anchorage, Alaska, 1991–1995. *Journal of Safety Research* 30: 219–223.
- General Motors Corporation. 2003. Cadillac DeVille night vision. Available from the internet. URL: <http://www.cadillac.com/cadillacjsp/models/feature.jsp?model=devilleandfeature=nightvision>. Accessed 9 September 2003.
- Gordon, K., S.H. Anderson, B. Gribble, and M. Johnson. 2001. *Evaluation of the FLASH (Flashing Light Animal Sensing Host) system in Nugget Canyon, Wyoming*. Wyoming Cooperative Fish and Wildlife Research Unit. University of Wyoming. Laramie, WY, USA.
- Gordon, K.M. and S.H. Anderson. 2002. Motorist response to a deer-sensing warning system in western Wyoming. In *2003 Proceedings of the International Conference on Ecology and Transportation*. 24-28 September 2001. Keystone, CO, USA. pp. 549-558.
- Gordon, K.M., M.C. McKinstry and S.H. Anderson. 2004. Motorist response to a deer sensing warning system. *Wildlife Society Bulletin* 32: 565-573.
- Government of Newfoundland and Labrador. 1997. Results of review of moose-vehicle collisions. News release 11 July 1997. Available from the internet. URL: <http://www.gov.nf.ca/releases/1997/forest/0711n02.htm>.
- Green, M. 2000. “How long does it take to stop?” Methodological analysis of driver perception-brake times. *Transportation Human Factors* 2: 195-216.
- Groot Bruinderink, G.W.T.A. and E. Hazebroek. 1996. Ungulate traffic collisions in Europe. *Conservation Biology* 10: 1059-1067.
- Gunther, K.A., M.J. Biel, and H.L. Robison. 1998. Factors influencing the frequency of road-killed wildlife in Yellowstone National Park. In *Proceedings from the International Conference on Wildlife Ecology and Transportation*. Evink G.L., P. Garrett, D. Zeigler, and J. Berry (eds). FL-ER-69-98. Florida Department of Transportation. Tallahassee, Florida, USA.
- Haikonen, H. and H. Summala. 2001. Deer–vehicle crashes: extensive peak at 1 hour after sunset. *American Journal of Preventive Medicine* 21(3): 209-213.

Hammond, C. and M.G. Wade. 2004. *Deer avoidance: the assessment of real world enhanced deer signage in a virtual environment*. Final Report. Minnesota Department of Transportation. St. Paul, Minnesota, USA. Available from the internet. URL: <http://www.lrrb.gen.mn.us/pdf/200413.pdf>. Accessed 30 November 2004.

Hirota, M., Nakajima, Y., Saito, M., and Uchiyama, M. 2004. Low-Cost Infrared Imaging Sensors for Automotive Applications. In *Advanced Microsystems for Automotive Applications*. Valldorf, J. and W.Gessner (Eds.). 2004: 63-84. Also available from the internet. URL: http://www.springeronline.com/sgw/cda/pageitems/document/cda_downloaddocument/0,11996,0-0-45-110604-0,00.pdf. Accessed 26 September 2004.

Honda Motor Co., Ltd. 2004. Intelligent night vision system able to detect pedestrians and provide driver cautions. Available from the internet. URL: <http://www.all4engineers.de/preview.php?cms=andlng=enandalloc=34andid=560>. Accessed 26 September 2004.

van den Hoorn, D. 2000. Reflector of laserstraal: beter dan “wildspiegel”. Aantal aanrijdingen met grofwild op Veluwe nog veel te groot. *Het Edelhert*. 35 (1): 9-12.

Hughes, W.E., A.R. Saremi and J.F. Paniati. 1996. Vehicle-animal crashes: an increasing safety problem. *Institute of Transportation Engineers Journal* 66: 24-28.

Huijser, M.P. 2003. Animal detection systems: research questions, methods and potential applications: 9 p. In *Proceedings of Infra Eco Network Europe (IENE) conference*. Habitat Fragmentation due to Transport Infrastructure and Presentation of the COST 341 action. 13-15 November 2003. Brussels, Belgium. CD-ROM from the internet. URL: <http://www.iene.info/>. Accessed 27 September 2004.

Huijser, M.P. and P.J.M. Bergers. 2000. The effect of roads and traffic on hedgehog (*Erinaceus europaeus*) populations. *Biological Conservation* 95: 111-116.

Huijser, M.P. and P.T. McGowen. 2003. Overview of animal detection and animal warning systems in North America and Europe. In *2003 Proceedings of the International Conference on Ecology and Transportation*. C.L. Irwin, P. Garrett, and K.P. McDermott (eds.). pp. 368-382. Center for Transportation and the Environment. North Carolina State University. Raleigh, NC, USA. Also available from the internet. URL: <http://www.itre.ncsu.edu/cte/icoet/03proceedings.html>.

Huijser, M.P. and P.T. McGowen. 2004. The comparison of animal detection systems in a test-bed: A quantitative comparison of system reliability and experiences with operation and maintenance. Scope of work. Western Transportation Institute. College of Engineering. Montana State University - Bozeman. Bozeman, MT, USA.

Huijser, M.P., K.E. Gunson and C. Abrams. 2006b. *Animal-vehicle collisions and habitat connectivity along US Highway 83 in the Seeley-Swan Valley: a reconnaissance*. Report No. FHWA/MT-06-002/8177. Western Transportation Institute – Montana State University. Bozeman, USA.

Huijser, M.P., W. Camel and A. Hardy. 2006a. The reliability of the animal detection system along US Hwy 191 in Yellowstone National Park, Montana, USA. In *Proceedings of the 2005 International Conference on Ecology and Transportation*. C.L. Irwin, P. Garrett and K.P. McDermott (eds.). pp. 509-523. Center for Transportation and the Environment. North Carolina State University. Raleigh, NC. USA. URL: http://www.icoet.net/ICOET_2005/05proceedings_directory.asp.

Huinin, J. 2005. Nepgeluiden klopjacht redden dierenlevens. *Volkskrant* 21 May 2005. The Netherlands.

Indiana Department of Transportation. Quarterly Reports: January-March 2003. Research Division. Indiana Department of Transportation. Joint Transportation Research Program. Available from the internet. URL: http://rebar.ecn.purdue.edu/JTRP/ProgAdmin/Quarterly_Reports/2495_1_03.pdf. Accessed 15 August 2003.

Jacobs, P., D. Lier and D. Schopflocher. 2004. Long term medical costs of motor vehicle casualties in Alberta (1999): a population – based, incidence approach. *Accident Analysis and Prevention* 36: 1099–1103.

Katz, B.J., G.K. Rousseau, and D.L. Warren. 2003. Comprehension of warning and regulatory signs for speed. *Proceedings 73rd Institute of Transportation Engineers (ITE) Annual Meeting and Exhibit*. August 24-27, 2003. Seattle, WA, USA.

Khattak, A.J. 2003. Human fatalities in animal-related highway crashes. Paper 03-2187. TRB 2003 Annual Meeting CD-ROM.

Kinley, T.A., N.J. Newhouse and H.N. Page. 2003. Evaluation of the Wildlife Protection System Deployed on Highway 93 in Kootenay National Park During Autumn, 2003. November 17, 2003. Sylvan Consulting Ltd. Invermere, British Columbia, Canada.

Kistler, R. 1998. Wissenschaftliche Begleitung der Wildwarnanlagen Calstrom WWA-12-S. Juli 1995 - November 1997. Schlussbericht. Infodienst Wildbiologie and Oekologie. Zürich, Switzerland.

Kistler, R. 2002. Wildwarnanlagen bewähren sich. *CH Wild Info* (1): 1-2. Available from the internet. URL: http://www.wild.unizh.ch/wininfo/wininfo_pdf/wininfo021.pdf. Accessed 12 August 2003.

Kloeden, C.N., A.J. McLean, V.M. Moore and G. Ponte. 1997. *Traveling speed and the risk of crash involvement*. Volume 1 – Findings. NHMRC Road Accident Research Unit. University of Adelaide. Australia.

Knapp, K., X. Yi, T. Oakasa, W. Thimm, E. Hudson, and C. Rathmann. 2004. *Deer-vehicle crash countermeasure toolbox: a decision and choice resource*. Final report. Report Number DVCIC – 02. Midwest Regional University Transportation Center. Deer-Vehicle Crash Information Clearinghouse. University of Wisconsin-Madison. Madison, WI, USA.

- Lavsund, S. and F. Sandegren. 1991. Moose-vehicle relations in Sweden: a review. *Alces* 27: 118-126.
- Lehnert, M.E. and J.A. Bissonette. 1997. Effectiveness of highway crosswalk structures at reducing deer-vehicle collisions. *Wildlife Society Bulletin* 25(4): 809-818.
- Los Alamos National Laboratory (LANL). 1997. Laboratory safety officials urge motorists to be wary of elk. Press release. Los Alamos National Laboratory. 1 December 1997. <http://www.lanl.gov/worldview/news/releases/archive/97-181.shtml>.
- Los Alamos National Laboratory (LANL). 2004. Talk at Laboratory's Bradbury Science Museum Thursday on impacts of area's growing elk population. Press release. Los Alamos National Laboratory. 20 April 2004. <http://www.lanl.gov/worldview/news/releases/archive/04-030.shtml>.
- Maine Department of Transportation. 2001. *Collisions between large wildlife species and motor vehicles in Maine*. Interim report. Maine Interagency Work group on Wildlife/Motor Vehicle Collisions. Maine Department of Transportation. Augusta, Maine, USA.
- Marron and Associates, Inc. 2005. Tijeras Canyon Wildlife Safe Passage Feasibility Study, Bernalillo County, New Mexico. Marron and Associates, Inc., Albuquerque, NM, USA. Available from the internet. URL: <http://nmgrip.com/projects.asp?project=15050andlinkid=15246>. Accessed 24 February 2006.
- Minnesota Department of Transportation (MNDOT). 2001a. New deer alert system may lessen motorist-deer collisions in Minnesota. Minnesota Department of Transportation. News release. 12 June 2001. Available from the internet. URL: <http://www.dot.state.mn.us/d8/newsrels/01/0612deeralertsystem.html>. Accessed 15 August 2003.
- Minnesota Department of Transportation (MNDOT). 2001b. MN/DOT suspends deer alert system test near Marshall during winter months. Minnesota Department of Transportation. News release. 9 November 2001. Available from the internet. URL: <http://www.dot.state.mn.us/newsrels/01/11/09deeralert.html>. Accessed 15 August 2003.
- de Molenaar, J.G. and R.J.H.G. Henkens. 1998. Effectiviteit van wildspiegels: een literatuurevaluatie. IBN rapport 362. Instituut voor Bos- en Natuuronderzoek, Wageningen, The Netherlands.
- Mosler-Berger, Chr. and J. Romer. 2003. Wildwarnsystem CALSTROM. *Wildbiologie* 3: 1-12.
- Muurinen, I. and T. Ristola. 1999. Elk accidents can be reduced by using transport telematics. *Finncontact* 7 (1): 7-8. Available from the internet. URL: <http://www.tiehallinto.fi/fc/fc199.pdf>. Accessed 8 August 2003.
- National Cooperative Highway Research Program (NCHRP). 2002. Animal Vehicle Crash Mitigation Using Advanced Technologies. Available from the internet. URL: <http://www.pooledfund.org/projectdetails.asp?id=305andstatus=6>. Accessed 27 September 2004.

New York Times. 2001. Sequim Journal: elk that call ahead to cross the highway. The New York Times, 2 January 2001. Available from the internet. URL: <http://www.nytimes.com/2001/01/02/technology/02ELK.html?ex=1061092800&den=463ee007e20722bc&dei=5070>. Accessed 14 August 2003.

Newhouse, N.J. 2003. The wildlife protection system: early successes and challenges using infrared technology to detect deer, warn drivers, and monitor deer behavior. In *2003 Proceedings of the International Conference on Ecology and Transportation*. C.L. Irwin, P. Garrett, and K.P. McDermott (eds.). pp. 390-391. Center for Transportation and the Environment. North Carolina State University. Raleigh, NC, USA. Also available from the internet. URL: <http://www.itre.ncsu.edu/cte/icoet/03proceedings.html>.

Oh DEER, Inc., Inc. 2004. Operations manual. Oh DEER, Inc. Mason City, IA, USA.

Pfister, H.P., V. Keller, D. Heynen and O. Holzgang. 2002. Wildtierökologische Grundlagen im Strassenbau. *Strasse und Verkehr* (3): 101-108.

Pignataro, L.J. 1973. *Traffic engineering: theory and practice*. Prentice-Hall, Inc., Englewood Cliffs, N.J., USA.

Pojar, T.M. R.A. Prosen, D.F. Reed and T.N. Woodard. 1975. Effectiveness of a lighted, animated deer crossing sign. *Journal of Wildlife Management* 39: 87-91.

Proctor, M.F. 2003. Genetic analysis of movement, dispersal and population fragmentation of grizzly bears in southwestern Canada. Unpublished dissertation. The University of Calgary, Calgary, Canada.

Pynn, T.P. and B.R. Pynn. 2004. Moose and other large animal wildlife vehicle collisions: implications for prevention and emergency care. *Journal of Emergency Nursing* 30 (6): 542-547.

Rathey, T.E. and N.E. Turner. 1991. Vehicle-moose accidents in Newfoundland. *The Journal of Bone and Joint Surgery* 73 (10): 1487-1491.

Rea, R.V. 2004. Investigating methods to reduce urban moose-related vehicular collisions within the city of Prince George, British Columbia. Ecosystem Science and Management Program. University of Northern British Columbia. Prince George, British Columbia, Canada.

Reed, D.F., Th.D.I. Beck and Th.N. Woodward. 1982. Methods of reducing deer-vehicle accidents: benefit-cost analysis. *Wildlife Society Bulletin* 10: 349-354.

Reeve, A.F. and S.H. Anderson. 1993. Ineffectiveness of Swareflex reflectors at reducing deer-vehicle collisions. *Wildlife Society Bulletin* 21: 127-132.

Robertson, H.D. 2000. Spot speed studies. In *Manual of Transportation Engineering Studies*. Robertson, H.D., J.E. Hummer and D.C. Nelson (eds). pp: 33-51. Institute of Transportation Engineers. Washington, DC, USA.

Robinson, M., P. McGowen, A. Habets and C. Strong. 2002. Safety Applications of ITS in Rural Areas. Science Applications International Corporation. McLean, VA, USA. Available from the internet. URL: http://www.itsdocs.fhwa.dot.gov/JPODOCS/REPTS_TE/Contents.htm. Accessed 14 August 2003.

Romer, J. and Chr. Mosler-Berger. 2003. Preventing wildlife-vehicle accidents. The animal detection system CALSTROM: 3 p. *Proceedings of Infra Eco Network Europe (IENE) Conference*. Habitat fragmentation due to Transport Infrastructure and Presentation of the COST 341 action, 13-15 November 2003, Brussels, Belgium. CD-ROM from the internet. URL: <http://www.iene.info/>. Accessed 27 September 2004.

Romin, L.A. and J.A. Bissonette. 1996. Deer-vehicle collisions: status of state monitoring activities and mitigation efforts. *Wildlife Society Bulletin* 24: 276-283.

Schwabe, K.A., P.W. Schuhmann, M.J. Tonkovich and E. Wu. 2002. An analysis of deer-vehicle collisions: the case of Ohio. In *Human conflicts with wildlife: economic considerations*. L. Clark (Ed.). pp. 91-103. National Wildlife Research Center. Fort Collins, CO, USA.

Sensor Technologies and Systems, Inc. (STS). 2002. Roadway animal detection system. Operator's manual and installation guide. RADS-00-007-OM. 16 October 2002. Revision 4. Scottsdale, AZ, USA.

Shiple, L.A. 2001. *Evaluating Wolfin as a repellent to wildlife on roads in Washington and the feasibility of using deer-activated warning signs to reduce deer-automobile collisions on highways in Washington*. Research report. Research Project #T9902. Department of Natural Resource Sciences. Washington State University. Pullman, WA, USA.

Sielecki, L.E. 2004. *WARS 1983-2002. Wildlife accident reporting and mitigation in British Columbia: special annual report*. Ministry of Transportation. Engineering Branch. Environmental Management Section. Victoria, British Columbia, Canada.

Sullivan, T.L. and T.A. Messmer. 2003. Perceptions of deer-vehicle collision management by state wildlife agency and department of transportation administrators. *Wildlife Society Bulletin* 31: 163-173.

Tardif, L-P and Associates Inc. 2003. Final report. Collisions involving motor vehicles and large animals in Canada. L-P Tardif and Associates Inc. Nepean, Ontario, Canada.

Taskula, K. 1997. The moose ahead. *Traffic Technology International*: 170-173.

Taskula, K. 1999. Elk warning system on highway 7. Tielaitos, Helsinki, Finland.

The Post Bulletin. 2005. State looking for a better way to prevent deer-car crashes. The Post Bulletin. 12 December 2005. Available from the internet: URL: <http://www.twincities.com/mld/twincities/news/state/minnesota/13386643.htm>. Accessed 12 February 2006.

- Thomas, E. 1995. Moose-vehicle accidents on Alaska's rural highways. State of Alaska. Department of Transportation and Public Facilities. Central Region. Design and Construction Division. Alaska, USA.
- Trawén, A., P. Maraste and U. Persson. 2002. International comparison of costs of a fatal casualty of road accidents in 1990 and 1999. *Accident Analysis and Prevention* 34: 323-332.
- Tschudin, M. 1998. Erfolgreiche Wildwarnanalgen. CH Wild Info (6): 1-2. Available from the internet. URL: http://www.wild.unizh.ch/wininfo/wininfo_pdf/wininfo986.pdf. Accessed 12 August 2003.
- U.S. Department of Transportation. 2002. Considering Safety in the Transportation Planning Process. U.S. Department of Transportation. Washington, DC, USA.
- U.S. Department of Transportation. 2003. *Economic Analysis Primer*. FHWA IF-03-032. Office of Asset Management (HIAM). Federal Highway Administration. U.S. Department of Transportation. Washington, DC, USA.
- Ujvári, M., H.J. Baagøe and A.B. Madsen. 1998. Effectiveness of wildlife warning reflectors in reducing deer-vehicle collisions: a behavioural study. *Journal of Wildlife Management* 62: 1094-1099.
- Weir, E. 2002. Collisions with wildlife: the rising toll. *Canadian Medical Association Journal* 166: 775.
- White, P.J. and R.A. Garrott. 2005. Yellowstone's ungulates after wolves – expectations, realizations, and predictions. *Biological Conservation* 125: 141-152.
- Williams, A.F. and J.K. Wells. 2004. Characteristics of vehicle-animal crashes in which vehicle occupants are killed. Insurance Institute for Highway Safety. Arlington, VA, USA.
- Williams, D. 1999. Elk, drivers benefit from crossing project. *Northwest Indian Fisheries Commission News XIV* (2): 12. Available from the internet. URL: <http://nwifc.wa.gov/newsletter/Summer99/12.asp>. Accessed 15 August 2003.
- Washington State Department of Transportation (WSDOT). 2003a. Deer laser warning beacon test begins on US 97A. Washington State Department of Transportation. News Release 23. October 2002. URL: http://www.wsdot.wa.gov/regions/northcentral/communication/102302-Deer_Laser_Test.htm. Accessed 15 August 2003.
- Washington State Department of Transportation (WSDOT). 2003b. Deer laser test continues on US 97A north of Wenatchee. Washington State Department of Transportation. News Release 17. January 2003. Available from the internet. URL: <http://www.wsdot.wa.gov/regions/northcentral/communication/011703-Deer%20Laser%20Update.htm>. Accessed 15 August 2003.

Western Transportation Institute (WTI). 2002a. Announcing: The US Highway 191 driver warning system. Western Transportation Institute. Montana State University. Bozeman, MT, USA.

Western Transportation Institute (WTI). 2002b. The animal detection system along Hwy 191 between mile marker 28 and 29. Western Transportation Institute. Montana State University. Bozeman, MT, USA.

Wu, E. 1998. Economic analysis of deer-vehicle collisions in Ohio. In *Proceedings from the International Conference on Wildlife Ecology and Transportation*. Evink G.L., P. Garrett, D. Zeigler, and J. Berry (eds). pp 43-52. FL-ER-69-98. Florida Department of Transportation, Tallahassee, Florida, USA.

van der Zee, F.F., J. Wiertz, C.J.F. ter Braak, R.C. van Apeldoorn and J. Vink. 1992. Landscape change as a possible cause of the badger *Meles meles* L. decline in The Netherlands. *Biological Conservation* 61: 17-22.

APPENDICES

APPENDIX A: TECHNICAL ADVISORY COMMITTEE MEMBERS

Contact Information – Technical Advisory Committee (TAC) Members and FHWA
Representative, December 2005

Clint Adler

Alaska Department of Transportation and Public Facilities

2301 Peger Rd, Fairbanks AK 99709

Tel: 907-451-5321, Fax: 907-451-5126, E-mail: clint_adler@dot.state.ak.us

Pete Hansra

California Department of Transportation

PO Box 942873, Sacramento CA 94273-0001

Tel: 916-654-7252, Fax: 916-657-4580, E-mail: Gurprit_Hansra@dot.ca.gov

Sedat Gulen

Indiana Department of Transportation

3600 North Ocean Drive Apt. # 301 Singer Island, FL 33404

Phone: 561-845-8410 or 765-463-1521 ext 246, E-mail: sedatg@hotmail.com or
sedatg@highstream.net

Jaime Reyes

Iowa Department of Transportation

800 Lincoln Way, Ames, IA 50010

Phone: 515-239-1077, Fax: 515-239-1891, E-mail: jaime.reyes@dot.iowa.gov

Andrew Morrow, Rex McCommon and Dave Church

Kansas Department of Transportation

700 SW Harrison, 6th Floor, Topeka, KS 66603-3754

Phone: 785-296-1141 (Andrew Morrow), 5169 (Rex McCommon), or 3618 (Dave Church)

E-mail: Morrow@ksdot.org, Rex@ksdot.org, or Church@ksdot.org

William Branch

Maryland Department of Transportation

707 North Calvert Street, Mailstop C-306, Baltimore, MD 21202

Phone: 410-545-8626, Fax: 410-209-5003, E-mail: WBranch@sha.state.md.us

Deb Wambach

Montana Department of Transportation

2701 Prospect Avenue, Helena, MT 59620-2701

Phone: 406- 444-0461, Fax: 406-444-7245, E-mail: dwambach@mt.gov

Jay Van Sickle

Nevada Department of Transportation

1263 South Stewart St., Carson City, NV 89712

Phone: 775-888-7467, E-mail: jvansickle@dot.state.nv.us

Greg Placy
New Hampshire Department of Transportation
641 Main Street, Lancaster, NH, 03584
Phone: 603-788-4641, Fax: 603-788-4260
E-mail: gplacy@dot.state.nh.us

Allan Covlin
North Dakota Department of Transportation
608 East Boulevard Avenue, Bismarck, ND 58505-0700
Phone: 701-328-4398, Fax: 701-328-1404, E-mail: acovlin@state.nd.us

Felix Martinez
Oregon Department of Transportation (**lead state**)
200 Hawthorne SE Suite B-240, Salem, OR 97301-5192
Phone: 503-986-2848, Fax: 503-986-2844, E-mail: Felix.C.MARTINEZ@odot.state.or.us

Jon Fleming
Pennsylvania Department of Transportation
400 North Street, 6th Floor
Harrisburg, PA 17120
Phone: 717-772-1771, E-mail: JonFleming@state.pa.us

John Kinar and Richard Stark
Wisconsin Department of Transportation
PO Box 7986, 4802 Sheboygan Ave; Room 501, Madison, WI 53707-7986
Phone: 608-266-1202 (John Kinar) or 3943(Richard Stark), Fax: 608-267-7856, E-mail:
john.kinar@dot.state.wi.us or richard.stark@dot.state.wi.us

Bill Gribble and Kevin Powell
Wyoming Department of Transportation
5300 Bishop Blvd., Cheyenne, WY, 82009-3340
Phone: 307-777-4433/4192 (Bill Gribble) or 3997 (Kevin Powell), Fax: 307-777-4759 (Bill Gribble) or 307-777-4193 (Kevin Powell), E-mail: Bill.Gribble@dot.state.wy.us or kevin.powell@dot.state.wy.us

Kyle Williams
New York State Department of Transportation
50 Wolf Road POD 41, Albany, NY 12232
Phone: 518-457-5566, E-mail: kwilliams@dot.state.ny.us

Carol Tan
Federal Highway Administration (FHWA), Turner-Fairbank Highway Research Center,
HRDS-06, 6300 Georgetown Pike, McLean, VA 22101-2296, Phone: 202-493-3315, Fax: 202-493-3374, E-mail: carol.tan@fhwa.dot.gov

APPENDIX B: FINANCIAL REPORT

A-V pooled fund thru 12/31/05				
428563				
	Budget	Spent thru 12/31/05	outstanding expense	Remaining
salaries	140,156.00	217,535.66		(77,379.66)
benefits	37,842.00	54,212.89		(16,370.89)
travel	50,000.00	25,467.98		24,532.02
communication	3,000.00	2,325.19		674.81
contracted svcs	2,000.00	43,646.53		(41,646.53)
supplies	3,000.00	3,892.97		(892.97)
rent	0.00	795.23		(795.23)
Equipment	465,032.00	376,655.00		88,377.00
subcontracts	43,571.00			43,571.00
awards	0.00	1,934.40		(1,934.40)
Part. Support	66,000.00	49,383.57		16,616.43
Total Direct costs	810,601.00	775,849.42		34,751.58
IDCs	104,399.00	139,150.58		(34,751.58)
Total	915,000.00	915,000.00	0.00	0.00
UTC funds 428467				
	Budget	Spent thru 12/31/05	outstanding expense	Remaining
salaries	48,523.00	39,023.16		9,499.84
benefits	13,113.00	9,549.68		3,563.32
travel	100.00	1,288.96		(1,188.96)
communication	50.00	226.64		(176.64)
contracted svcs	21,428.00	21,428.00		0.00
supplies	2,500.00	2,517.90		(17.90)
Total Direct costs	85,714.00	74,034.34	0.00	11,679.66
IDCs	34,286.00	29,613.76		4,672.24
Total	120,000.00	103,648.10	0.00	16,351.90

APPENDIX C: PROJECT HISTORY

Date	General Activities	Montana Site	Pennsylvania Site
Oct 1999	Start project 27 Oct.		
Jan-Apr 2000	Request For Information (RFI) advertised.		
May 2000	Vendors presented to the Technical Advisory Committee (TAC) in response to the RFI on 5 May. Top four study sites in IA, IN, MT and OR selected by TAC on 6 May. MT was selected as the first choice; the other sites to be selected when money is available or if the MT site falls through.		
May-Jul 2000	Draft Memorandum Of Understanding (MOU) and Request For Proposal (RFP) developed and modified for the project partners. Study site descriptions updated.		
Aug 2000	Site visits conducted: IN 15 Aug, IA 16 Aug. RFP was finalized and advertised 18 Aug. Responses to questions from vendors sent 30 Aug. MOU between IA, IN, MT, OR and WTI-MSU finalized and distributed for signature.	Site visit: 1 Aug.	
Sep 2000	Steering committee meeting 28-30 Sep. Animal behavior document presented to TAC (Farrell, 2002).	Sensor Technologies and Systems (STS), Scottsdale, AZ selected as vendor.	
Oct 2000		Contract developed for STS.	
Nov 2000		Draft contract with STS presented to TAC on 7 Nov. Contract finalized and sent to STS. Coordination with Montana Department of Transportation (MDT) for system installation.	
Dec 2000		Signing plan developed.	
Feb 2001	Page: 224 After the contract changes with STS	STS determines they are unable to fulfill the requirements in their	

Date	General Activities	Montana Site	Pennsylvania Site
	the project could only afford to have one location (MT).	proposal and asks for substantial increase in budget. RFP modified and re-advertised because of delays with STS.	
Apr 2001		Contract finalized with STS.	
May 2001		Further work on signing plan. Applied for research permit with Yellowstone National Park (YNP).	
		Field review with Doug Moeller (MDT) on 5 Jun. Final field review with YNP and MDT on 12 Jun. Further work on signing and other design issues.	
Jul 2001		Finalized signing plan. Further coordination with YNP on system design.	
Aug 2001	Contacted and sent information to AK, NE, KS Department Of Transportation (DOT) for participation in the study. Coordinated panel discussion at RATTSS conference regarding animal detection and driver warning systems.	Continued to coordinate with STS, MDT and YNP regarding system design. YNP issued the research permit. Developed a brochure to provide info to the general public.	
Sep 2001		STS asked for extension to 17 Nov to allow for major changes in system design.	
Oct 2001		Site visit for additional measurements for post locations. Teleconference with STS and MDT detailing delivery and installation issues. At this point MDT maintenance staff was not be able to install system until Jun 2002 because of the winter. Delivery was still planned for Nov 2001 with equipment stored at MDT Maintenance in Bozeman.	
Nov 2001	AK decided to participate in the study. Additional info was provided to AK.		

Date	General Activities	Montana Site	Pennsylvania Site
	<p>Made contact with Pennsylvania DOT (PennDOT) regarding study participation.</p> <p>Funding secured for a second location, location still undecided.</p>		
Jan 2002	<p>KS joined the pooled fund study.</p> <p>Made presentation for PennDOT.</p>	<p>Letter submitted to STS stating shortfalls of the contract. Nevertheless, all but 10% of the funds were released to the vendor because STS needed the funds and could not wait until summer for system installation.</p>	
Feb 2002		<p>STS responded to most issues. Remaining issues included painting and poles.</p> <p>YNP tentatively agreed to the painting.</p>	<p>Oh Deer selected as vendor for second site (location still undecided)</p>
Mar 2002		<p>WTI assisted STS with pole strength requirement calculations.</p>	
Apr 2002		<p>STS slow in submitting info regarding dimensions, weight and configuration of system elements. This info needed to determine pole requirements. This had the potential to delay the Jun 2002 installation date.</p>	
May 2002		<p>Continued coordination with STS.</p> <p>MDT reorganized Maintenance division. MDT still committed to project, but key staff changed positions. This required additional coordination.</p>	<p>PA site selected. Draft contract developed for Oh Deer.</p>
Jun 2002		<p>Crash data analyzed.</p>	<p>Coordinated with PennDOT and Oh Deer to get power to site.</p>
Jul 2002		<p>STS redesigned system, separating several stations into two poles. Installation drawings were reviewed by WTI, YNP and MDT. All comments incorporated.</p> <p>Requested bids and pole sizes from 3 vendors recommended by MDT. Made initial contact with two MT based contractors and Michiana</p>	<p>Meeting in PA with Oh Deer on 31 Jul.</p> <p>Discussed and submitted MOU to PennDOT for signature.</p> <p>Received proposal from Oh Deer, prepared draft contract.</p> <p>Oh Deer suggested changing</p>

Date	General Activities	Montana Site	Pennsylvania Site
		Contracting (IN) for installation.	the system technology to motion radar. The new technology uses sensors that also point toward the road from the r-o-w. The system is designed to filter out detections caused by traffic. Oh Deer stated that the change in technology would be an improvement, as it should track the animal as long as it is on or near the road. It will not lose contact right after it has broken the beam. An addendum to the contract would be required for the change in system.
Aug 2002	Exhibit A was updated to reflect a change in Principal Investigator. Marcel Huijser replaced Pat McGowen.	After receiving the final design and specifications from STS, MDT checked pole strengths. WTI ordered poles accordingly. Bid package for installation submitted.	Field review conducted with PennDOT and Oh Deer on 2 Aug. Contract with Oh Deer signed.
Sep 2002	Coordinated conference call with TAC to be held 1 Oct.	Worked with MDT and Michiana Contracting to determine most cost effective method for installation.	Coordinated demonstration of Oh Deer's change in technology.
Oct 2002		Prepared for installation and coordinated between Michiana Contracting, Eagle Rock Timber, MDT, STS and YNP. Checked equipment, recharged batteries. Installation work started.	The TAC agreed to switch technology as proposed by Oh Deer. Oh Deer continued to prepare the engineering plans for PennDOT. Pat Wright (WTI-MSU) coordinated the modification of the contract with Oh Deer.
Nov 2002		Speed-readings were taken at the site. A power analysis was done to determine adequate sample sizes. WTI-MSU prepared a draft management plan for MDT for the operation and maintenance of the system. STS installed the circuit boards and updated telecommunication system. The system was switched on, appeared to work for a couple of days, but then malfunctioned	Oh Deer could not prepare the engineering plans for PennDOT to the level that is required (engineering standards). EandK, a consulting firm was contracted by PennDOT and took over the preparation of the engineering plans. Pat Wright continued to coordinate on site for WTI-MSU.

Date	General Activities	Montana Site	Pennsylvania Site
		<p>(almost continuous detections during certain periods), potentially because low temperatures caused malfunctioning of the radios. Note: the contract with STS stated that the system should work to -40 °C (-40 °F).</p> <p>Remote access to the system through cell phone was not possible, despite assurances by STS. Alternatives (satellite and land-based line) were explored.</p>	
Dec 2002		<p>The system did not meet the contract specifications and was not operational. Therefore MDT did not accept ownership of the system, nor responsibility for operation and maintenance.</p> <p>YNP suspended WTI-MSU's research permit because the responsibility for operation and maintenance was unclear.</p> <p>WTI-MSU wrote a second draft management plan for the system that addresses all known concerns of YNP.</p> <p>STS found that low temperatures could indeed cause malfunctioning of the radios. STS announced modification of the radios to address the problem. In the mean time MDT discovered that the radios do not meet the FCC regulations. This is in violation of the contract requirements. STS proposed to get an experimental license for the radios to address this issue.</p> <p>WTI-MSU analyzed the detection data and asked STS detailed questions that may help identify other potential problems.</p>	<p>EandK had not finished the plans yet.</p> <p>WTI provided information and advice to EandK, based upon the experiences with the MT site.</p>
Jan 2003		<p>The draft management plan was still in the legal office of MDT. Once the management plan was final and approved by YNP WTI-MSU's research permit could be reinstated.</p>	<p>EandK still not finished with the plans. WTI-MSU urged EandK to finish the plans quickly to allow for installation in the spring.</p>

Date	General Activities	Montana Site	Pennsylvania Site
		<p>STS acquired an experimental license for the radios which is good until 31 Dec 2004 (end research project). The experimental license can be renewed after that date. However, the TAC and WTI-MSU felt that this could only be a short-term solution. The long-term solution should be to replace the radios that meet the contract and FCC specifications.</p> <p>WTI-MSU visited the STS office on 24 Jan to voice concerns with the system and how the problems are being addressed.</p> <p>STS came out to the study site to fix all known problems on 27-30 Jan. These included problems with sensors and filters due to low temperatures, software communication problems with certain versions of Windows, software reporting "invalid" breaks-of-the-beams. In addition, a sensor and bracket arms that were damaged by the car that ran off the road were replaced. STS also found that vehicles caused "false positives" in a section. The beam was too close to the driving lane in the inside of a curve. Additional brackets were used to increase the distance between the sensors and the road. Finally a series of new problems was discovered; the two flashing beacons at each end turn on every now and then without being triggered by a "break of the beam", an elk sign disappeared, and STS had trouble finding a suitable modem for a land-based phone line. The beacons were unplugged and the Signs were covered.</p> <p>MDT ordered a new elk sign (one was missing).</p>	
Feb 2003		<p>STS identified the problem with the 2 randomly flashing beacons (early Feb). It is due to variability of the signals in the radios.</p>	<p>The engineering plans were not ready yet. Oh Deer did not deliver drawings and technical specifications, mostly because</p>

Date	General Activities	Montana Site	Pennsylvania Site
		<p>On 11 Feb STS said that they agreed to replace the current radios with a different type. This includes changes in the hardware and software. WTI-MSU stressed that STS should do extensive testing in their temperature chamber under low temperatures and that they should comply with all regulations, including FCC.</p> <p>STS continued to work on a short-term solution with the current radios, but that strategy was abandoned. STS concluded that the current radios are not reliable enough. STS will now focus solely on replacing the current radio system with a new radio system.</p> <p>MDT repeated that they would not accept ownership of the system, nor responsibility for operation and maintenance until the system meets the contract requirements and is fully operational.</p>	<p>Oh Deer lacked the capacity to do so.</p> <p>WTI-MSU contacted Oh Deer and EandK to improve communications and to solve the problems (teleconference 4 Mar). Oh Deer agreed to deliver essential information and hired a person that has the required expertise and skills. Oh Deer was to deliver this information on 14 March. In the mean time WTI-MSU contacted PennDOT to inform them about the status and to explore the possibility for a fast review of the plans by PENNDOT.</p>
Mar 2003		<p>MDT put their position regarding ownership, operation and maintenance of the system in writing.</p> <p>STS had a cash flow problem and stopped working on the project, at least temporarily. WTI-MSU sent STS a letter asking for more information. In addition WTI-MSU sought legal advice and advice from technical experts.</p>	<p>Oh Deer sent the required information and drawings to EandK on March 26.</p> <p>PennDOT expected to have a fast track review process once EandK submits the plans (much faster than the 6 weeks which are standard). The planning for the installation work by PENNDOT was expected to take 2 months as PENNDOT has much road repair to do after a harsh winter.</p>
Apr 2003		<p>WTI received a letter from YNP requesting more info on the status of the work on the animal detection system.</p> <p>WTI asked STS to give a detailed overview and budget of the work that needed to be done to make the animal detection system functional. STS sent this information on 7 Apr. WTI consulted an independent expert (Shel Leader) concerning the situation with STS.</p>	<p>EandK did not receive the required information from Oh Deer. Some technical specifications were still missing.</p>

Date	General Activities	Montana Site	Pennsylvania Site
May 2003		<p>WTI provided YNP with the requested information.</p> <p>MDT noticed some loose wires at a station. This could be the result of vandalism. WTI-MSU asked MDT to temporarily tape the wires to the equipment.</p> <p>STS announced that they expected to be able to resume working on the animal detection system again within 1-2 weeks. STS believed that they would have the system operational before the winter season (this is when we need to collect data most). In the mean time Steve Miller is no longer the contact person for STS.</p>	<p>EandK and Oh Deer are still working on some details of the engineering plan. It was close to completion though.</p> <p>PennDOT planned to accept the engineering plan once it was approved by EandK. Furthermore, the PennDOT crews that would be installing the detection system could start their activities shortly after the plans have been approved. This could allow installation of the system in summer and allow for testing before the rut of the white-tailed deer.</p>
Jun 2003		<p>On 4 Jun a teleconference was held between WTI-MSU, legal advisors of MSU and ODOT (Kevin Haas). WTI-MSU sent STS a letter and work schedule (26 Jun) with clear deliverables as STS had not sent such a schedule yet. However, on Fri 27 Jun we received the schedule from STS; WTI-MSU's letter and STS's schedule had crossed in the mail. WTI-MSU responded to the schedule presented by STS and additional questions of STS.</p> <p>STS planned to come out to the site on 22 Jul. STS resumed working on the system and aimed to have a working system before 1 Oct 2003.</p>	<p>It appeared that Oh Deer had delivered all the required information to EandK. EandK expected to finalize and approve of the plans within 1-2 weeks. Once a formal letter of approval had been sent to EandK the installation can be scheduled.</p> <p>Oh Deer received the chips for the circuit boards and was assembling the hardware in preparation for the installation.</p>
Jul 2003		<p>Terry Wilson replaced Steve Miller as the main contact at STS.</p> <p>On 22 Jul STS came out to the site in YNP for additional testing of the new communication system. The tests went well. STS reported that, in addition to the one elk sign that went missing a couple of months ago, another was loosened (1 bolt removed).</p> <p>On 25 Jul WTI-MSU received</p>	<p>EandK still had not finalized the engineering plans. New information (technical details) was required from Oh Deer every now and then, and that takes time.</p>

Date	General Activities	Montana Site	Pennsylvania Site
		<p>STS's response to WTI-MSU's letter of 26 Jun. STS stated that they were committed to deliver a working system before 1 Oct 2003.</p> <p>On 28 Jul WTI-MSU provided additional information to STS (i.e., pictures) regarding wires that were damaged several months ago. The damage seemed minimal and seemed to be the result of people attempting to climb the pole.</p>	
Aug 2003	<p>WTI-MSU worked on a manuscript that gives an overview of the experiences with operation and maintenance of all known animal detection systems throughout North America and Europe. The paper was presented at the ICOET conference in Lake Placid, NY 24-29 Aug 2003.</p>	<p>STS continued to work on hardware and software modifications in their laboratory.</p>	<p>EandK wrote a letter to PennDOT that the engineering plans are finished and that a review/pre-installation meeting should be held in the short term (Sep 2003).</p>
Sep 2003		<p>STS provided WTI-MSU and MDT with information on antennas that needed to be replaced. Since antennas affected the external dimensions of the system, YNP was asked for permission. Permission was obtained. MDT assisted STS with replacing the antennas.</p> <p>MDT also replaced all elk signs with a text sign that says "wildlife crossing". Text signs are stolen less frequently than signs that have an elk or a moose silhouette. The new signs can be folded in half (no message visible) if needed.</p> <p>STS came out to work on the system 23-29 Sep. STS made a range of modifications to the system.</p> <p>MDT planned to move ahead with the management plan and the hook-up to the land-based phone line after the system has shown to work well for a couple of weeks.</p>	<p>A review/pre-installation meeting was held on 23 Sep in Mifflintown, PA. The meeting was attended by representatives from WTI-MSU (Pat Wright and Marcel Huijser), PennDOT and EandK.</p> <p>PennDOT expected to sign the MOU shortly thereafter and hoped that the system could be installed end Oct 2003.</p>
Oct 2003	<p>WTI-MSU wrote a paper that identifies the research questions and research methods related to the evaluation of the reliability and</p>	<p>Shortly after STS left the site in Yellowstone the system started to produce many false detections. WTI-MSU summarized the data to</p>	<p>The MOU was signed by PennDOT.</p> <p>PennDOT ordered poles and</p>

Date	General Activities	Montana Site	Pennsylvania Site
	<p>effectiveness of animal detection systems. It also shows how animal detection systems could be applied and integrated with other mitigation measures.</p>	<p>help STS identify the problems and solve them (system visits on 10 Oct and 27 Oct). Some of the problems may have been related to the relatively short distance between the sensors. Most false detections occur during the daytime, indicating that low temperatures were not the main problem. Wet snow also proved to cause false detections. Wet snow can also stick to the sensors and block the signal until it melts off.</p> <p>Robb Larson (affiliated faculty staff at WTI-MSU) and Marcel Huijser, recorded the waveform of the signal and signal strength with an oscilloscope at section 4 while it was producing false detections. The information was sent to STS for further analyses.</p> <p>MDT unplugged the beacons and removed the signs shortly after it was concluded that the system still produced too many false detections.</p> <p>STS did further testing in their laboratory to help identify the problems. In addition, STS developed sleeves that should prevent snow from sticking to the sensors. STS expected to visit the site again within 1-2 weeks.</p>	<p>other equipment and expected to begin installation in a matter of a few weeks. The signs might not be available then, as it takes about 3 weeks to order them. However, the system could be installed before that time as long as the warning lights are left off.</p> <p>Oh Deer confirmed that they had all the parts they needed in house. Oh Deer was ready for installation.</p>
Nov 2003		<p>STS visited the site 18-24 Nov. STS and modified the short sections to reduce false positives and installed sleeves in front of the sensors to prevent snow and ice from accumulating under the eave of the tubes and blocking the signal.</p>	<p>Installation scheduled for December.</p>
Dec 2003		<p>Data downloaded on Dec 8 and 10 2003 indicated that a substantial portion of the data now relates to real world events such as the presence of animals, falling snow, and snow spray from snowplows and other traffic. The sleeves in front of the sensors seem to prevent the built-up of snow and</p>	

Date	General Activities	Montana Site	Pennsylvania Site
		<p>ice.</p> <p>The radio of station 21 was not reporting to the mast station. After talking to STS it seems that this is likely to be caused by a loose wire.</p> <p>A problem with the software causes the radio reports from station 3 not to show up in the detection log. This does not have consequences for the functionality of the system. The detections from section 9 and F do show up in the detection log.</p> <p>WTI-MSU interpreted the detections as well as possible, based on the pattern, time and location of the detections. About 41% of all detections seem to relate to animal crossings or the presence of animals in the right-of-way. Excluding snowstorms and detections caused by snow spray from snowplows (or other traffic), the percentage of animal related detections increases to 66%.</p> <p>The detections labeled as animal crossings peaked between 18:00-21:00 and 6:00-9:00. The time and direction of travel matches the observations of the caretakers of the Black Butte Ranch (Greg and Sarah Knetge), and the number of snow tracks was positively correlated with animal-crossing detections. This indicates that the system is indeed detecting elk crossing the road.</p> <p>WTI-MSU recommended replacing the sign “when flashing” with a sign that says “use extra caution when flashing”. Based on a recent study, this makes people more aware of the fact that there could still be animals on the road even when the system is not flashing.</p> <p>WTI-MSU visited the site on 28-30 Dec. The radio of station 21 did not have a loose connection. After</p>	

Date	General Activities	Montana Site	Pennsylvania Site
		<p>sending it to STS it appeared that a module had been left inactivated.</p> <p>WTI-MSU triggered the system at 20 m intervals between the sensors to check for false negatives. Some sections did not function well, and there were also problems with curves, traffic and slopes.</p> <p>WTI collected snow tracking data and compared them to the detection log. It seems that the system picked up the animals, but the number of animal tracks was low and the number of detections relatively high.</p> <p>Section A and 6 were found to produce many false detections.</p>	
Jan 2004		<p>WTI-MSU removed the circuit boards from station 6 and 10, and the boards from the sensor tubes from station 6, 10 and 21. These boards were sent to STS on 12 January.</p> <p>STS added variable controls to the boards to adjust the voltage, made adjustments so that the sensors remained equally sensitive over a wider temperature range, and they lowered the noise floor. This should make section 6, A, D and 8 less sensitive to false positives. These modifications could be made to the sensors of the other sections as well, but this is only necessary if those sections experience a problem.</p> <p>The modified circuit boards were received on 26 Jan. Installation instructions followed 27 Jan. WTI-MSU tried to install these boards on 29 Jan 2004. However, one board was missing, and WTI-MSU had trouble adjusting the controls for signal strength with an oscilloscope.</p>	<p>WTI-MSU visited the site Jan 8-9. The foundations were poured that week and the vegetation was trimmed.</p> <p>The signs had arrived at the maintenance yard and the flashing warning signs were supposed to be there as well. One long pole had not been ordered yet, but that could be done locally and on short term.</p> <p>The installation was delayed by snow and mud. However, the system could be installed shortly since the foundations were in. Once the weather improved, PennDOT could pull people from plowing snow to help Oh Deer with the installation of the equipment. Oh Deer said they were ready.</p> <p>A draft brochure with basic information on the system was written. However, PennDOT did not want to release any information about the system to the press and the general public until the system was functional.</p>
Feb 2004		<p>WTI-MSU visited the site 2-6 Feb. The missing board arrived from</p>	<p>It became clear that PENNDOT was not ready for installation</p>

Date	General Activities	Montana Site	Pennsylvania Site
		<p>STS. WTI-MSU tried to install the remaining boards and adjust the signal strength. We were only partly successful as the molding on the probe point broke (station 10). In addition we had trouble adjusting the signal strength with the oscilloscope, and the molding of a wire for a board in the tube for section a broke. The board and wire were sent back to STS for repair. WTI-MSU collected additional snow tracking data.</p> <p>WTI-MSU had multiple contacts with STS on 4 and 5 Feb to convince STS that they had to visit the site to get the system operational soon.</p> <p>WTI-MSU visited the site 13-19 Feb. Roger Werre (STS) was there 16-20 Feb. Besides downloading the data and consulting with STS, WTI-MSU did additional snow tracking. Roger Were made modifications to all circuit boards to reduce false positives. A thermostat now corrects for temperature fluctuations, and all circuit boards now have a control for the signal strength. The signal strength can now be optimized for the distance between sensors. These modifications are also expected to lead to a reduction in false negatives since the signal strength is no longer in saturation mode for short sections. In addition, sensors were switched and detection sections now have different codes.</p>	<p>until Mar or Apr due to snow removal, related priorities, and adverse weather in general. WTI-MSU stressed that the window to evaluate the system was getting extremely small, especially since we had to allow for a period during which potential problems are identified and solved.</p> <p>Oh Deer planned to deliver the equipment between 31 Mar and 4 Apr. Installation was set to start on 5 Apr. PennDOT and Oh Deer coordinated installation.</p>
Mar 2004		<p>WTI-MSU visited the site again 1-3 Mar and found that section E and 4 produced many false positives. Section F and 6 did not report any breaks of the beam after STS left.</p> <p>High snow blocked part of the sensors, and the snow level on other sections might have been high enough to make the signal bounce off the snow surface. This may explain the abundance of false</p>	

Date	General Activities	Montana Site	Pennsylvania Site
		<p>positives in section E and 4. The lack of detections (true or false) from section 6 and F may have been due to either high snow (blocking sensors) or a fault in the circuit board of station 10.</p> <p>WTI-MSU visited the site 17-18 Mar and 26 Mar and found that the signal strength had changed. Most of the sections had shifted upwards (into saturation mode), only 1 section shifted downwards. Signal strength was adjusted on 17 and 18 Mar, but the signal strength had shifted again by 26 Mar. It was now clear that potential blockage of the sensors by high snow levels was not the main problem.</p> <p>WTI-MSU also tested the circuit board of station 10 further and found that it was likely to be faulty. It was shipped back to STS. STS found that a module on the board was indeed faulty and repaired the board. It was successfully installed on 26 Mar.</p> <p>STS analyzed the data and thought about what may cause the signal strength to drift. Fluctuating snow levels were discussed as the signal may bounce off the snow surface. Higher or lower snow levels could therefore potentially cause changes in signal strength. However, STS now thinks that low temperatures could also cause changes in signal strength.</p> <p>WTI-MSU told STS that it is of the utmost importance to deliver a fully functional system ASAP.</p> <p>WTI-MSU applied for a renewal of WTI-MSU's research permit with YNP.</p> <p>MDT reported that state regulations on signage do not allow them to change the warning sign to "use extra caution when flashing". However, they will keep the suggestion in mind for when</p>	

Date	General Activities	Montana Site	Pennsylvania Site
		the regulations are up for renewal.	
Apr 2004		<p>WTI-MSU found that some of the concrete foundations and wooden poles in the right-of-way do not meet MDT and FHWA requirements for the clear-zone. Objects in the clear zone should not be higher than 4 inches. However, some of the concrete foundations are much higher than that. In addition, there is about ½ inch from the foundation to the actual break-away-point. Furthermore, some of the wooden poles have been buried too deep. There are 3 holes drilled into the poles as a break-away-point, but some of these holes are underground in stead of just above the ground. The contractor (Michiana Contracting) has acknowledged responsibility for this and is committed to correct the issue, with or without assistance or their subcontractor Eagle Rock Timber.</p> <p>New holes will be drilled above ground and additional weed free soil has to be deposited around some of the concrete foundations. WTI-MSU is communicating with YNP and Michiana Contracting with regard to the vegetation and soil regulations. We hope the issue will be solved later this month (May).</p> <p>WTI-MSU visited the site on 19 Apr and found that the signal strength had changed for most sections. Signal strength was adjusted and the results were reported to STS and MDT. In addition, detection data were downloaded and shared with STS and MDT.</p> <p>STS found that there are problems with the software that cause false positives.</p> <p>Steve Albert (Director WTI-MSU) and Marcel Huijser met with YNP</p>	<p>The system was not installed on 5 Apr. Despite earlier reports, the signal lights had not come in yet. In addition, details on the power requirements of the part of the system that is to be hooked up to a power line were missing. Oh Deer provided these details later to PennDOT. Furthermore, coordination between PennDOT and the telephone company (for remote access) seems to be experiencing delays. At the moment there is no date scheduled for installation.</p> <p>WTI-MSU communicated to Oh Deer and PennDOT that it is very important to install the system ASAP. Several new installation dates were agreed upon and then postponed for various reasons. Finally a new date was set: 11 May 2004.</p>

Date	General Activities	Montana Site	Pennsylvania Site
		<p>personnel on 20 Apr to discuss the status of the project and future plans. YNP expressed their deep concern with the dimensions of the system and how it affects the landscape aesthetics.</p> <p>When the ground thawed, STS wanted to establish remote access to the system by hooking it up to the land-based phone line that runs right by the master station.</p>	
May 2004	<p>Kevin Haas accepted a promotion to the ODOT Traffic Engineering and Operations Section. Bernie Jones will take over Kevin Haas's tasks temporarily.</p>	<p>STS visited the site 12-14 May. STS modified software and hardware and several faulty units were taken back to AZ for repair.</p> <p>MDT coordinated the hook-up of the system to the land-based phone line with 3-rivers Phone Company. The remote access was installed on 27 May.</p> <p>STS reported that they could only download part of the data through the remote access. STS is studying the cause for this problem.</p> <p>YNP tried to find weed-free soil for fill around the concrete foundations.</p>	<p>The system was installed 11 -13 May. The installation went relatively well, but several important issues are outstanding. The most important issues are that the detection part of the system did not effectively communicate with the unit with the signal warning lights. There was also some question whether the system indeed distinguished between passing vehicles and large moving objects in the right-of-way (e.g., deer or human models).</p> <p>PennDOT would not accept responsibility for ownership and maintenance of the system until Oh Deer delivered a "system" that meets the requirements specified in the contract. WTI-MSU withheld the payment (65%) from Oh deer until a "system" had indeed been delivered (rather than components that are not integrated into a system) and the basic requirements for the system as specified in the contract had been met.</p>
Jun 2004		<p>WTI-MSU visited the site on 8 Jun to download the data for STS, to help STS find out why the remote access was only partially functional.</p> <p>YNP delivered 40-50 cy of weed-free soil to the Daily Creek Trailhead on 9 Jun. This location is</p>	<p>Oh Deer and PennDOT were at the site 7-11 Jun. However, the most important issues were not resolved.</p> <p>Nick Henningsen (Oh Deer) sent an overview of the problems found and their current status.</p>

Date	General Activities	Montana Site	Pennsylvania Site
		<p>a couple of miles north of the study site.</p> <p>WTI-MSU continued to communicate with MDT, Yellowstone NP and Michiana Contracting about the specific requirements and regulations for fixing the problems with the concrete foundations and poles. No date was scheduled yet.</p>	<p>Oh Deer sent PennDOT an operation manual. PennDOT and WTI-MSU think the manual does not meet the expectations.</p> <p>The warning signs were turned around (unreadable) 3 weeks after the system was installed.</p>
Jul 2004		<p>STS visited the site 19 Jul - 3 Aug. Pat McGowen and Marcel Huijser met with STS representatives Lloyd Salsman and Randy Moore on 27 Jul to discuss the work. Lloyd and Randy showed data that showed the cause of the false positives: high vegetation, moving vegetation, wet vegetation, passing semi's and buses, flying birds. This is the first time that the external causes of false positives (other than snow spray from snowplows, falling snow, ice and snow in front of the sensors) were properly documented. Vegetation and passing vehicles or flying birds were not considered a major problem when the system was designed. Randy and Lloyd showed that the "signal signature" of humans or horses breaking the beam was very different from that of detections caused by vegetation or passing vehicles. They placed a software filter over the data to distinguish between "valid" and "invalid" detections to drastically reduce the number of false positives. Randy and Lloyd also found additional faults in some sensors and circuit boards. Sections 1, 8, 4 and E were still suffering from technical problems.</p> <p>YNP personnel oversaw trimming of the vegetation at selected sections between the sensors. They also helped trigger the beam at different sections with a horse. This allowed verification of specific signal signatures that relate to valid beam breaks by</p>	<p>Oh Deer's system continued to experience problems and most of these problems have not been solved yet.</p> <p>The system had not been accepted by PennDOT. PENNDOT anticipated writing a formal letter about this to Oh Deer.</p> <p>WTI-MSU sent Oh Deer a letter stating that the 65% payment would not be paid until a system was delivered, rather than a collection of components. The letter also listed additional requirements.</p> <p>EandK delivered "as-built" technical drawings.</p> <p>WTI-MSU sent PENNDOT a letter transferring ownership of the animal detection system equipment.</p>

Date	General Activities	Montana Site	Pennsylvania Site
		<p>large animals.</p> <p>Randy and Lloyd found that the telephone line (for remote access) was dead. 3-Rivers Phone Company found out that a part in the telephone hook-up had broken (26 Jul). 3-Rivers replaced the part on 30 Jul.</p>	
Aug 2004	<p>WTI-MSU talked with MDT and PennDOT about their expectations and wishes with regard to the study sites after 31 Dec 2004.</p>	<p>Remote access appeared to be working fine, but after Lloyd and Randy left the site problems occurred. These problems seem to be related to the software. Only part of the data could be downloaded. Later (around 19 Aug) the remote access stopped functioning completely. This appeared to be a hardware issue, either with the equipment from 3-Rivers or STS.</p> <p>Randy indicated that STS would come out again between 1 and 15 Sep to upgrade the software, and to replace faulty hardware (section 1, 8, 4 and E). In addition, the master circuit board may have had some specific problems related to section 1 and the remote access.</p> <p>WTI-MSU sent Walker Butler (president STS) a letter stating that WTI-MSU appreciates the current efforts. However, WTI-MSU also stated that the current level of effort should have been undertaken over 1 year ago.</p> <p>Dave Delp from Michiana Contracting hired Eagle Rock Timber to fix the problems with the foundations and poles. The concrete foundations were fixed on 10 Aug. MDT provided traffic control. Additional holes in the wooden poles have not been drilled yet.</p> <p>STS did tests in AZ regarding the communication of the system. STS still planned on coming out to the site around mid Sep to replace faulty equipment and identify other</p>	<p>New radios arrived at Oh Deer's engineers. Oh Deer planned to come out to the site around the end of Sep.</p> <p>Oh Deer had not yet replied to WTI-MSU's letter of the previous month. However, they did say that the stand alone issue of software would be an issue for them. WTI-MSU replied that stand alone software is still required. Oh Deer also stated that they had a new version of the operation manual, but PennDOT had not received it yet.</p>

Date	General Activities	Montana Site	Pennsylvania Site
		<p>potential problems and strategies to solve these problems. For example; remote access to the data failed again, perhaps due to the computer in the master station, perhaps due to broken equipment from the phone company.</p>	
Sep 2004		<p>STS had not submitted their trip report yet.</p> <p>STS went out to the site in IN. They had the system operational (with beacons plugged in) by 10 Oct. Sedat Gulen confirmed that the system seemed to have been working well since that date. This is good news for the MT site too.</p> <p>STS planned to come out to the MT site between 1 and 7 Nov. They would have about 2 weeks work. They hoped/expected to have the system operational by 15 Nov.</p> <p>In the mean time someone hired by STS would check the batteries of the system 22–23 Oct. Many of the batteries in IN were low in fluid causing power problems.</p> <p>Eagle Rock Timber drilled additional holes in some of the wooden poles. All problems with the foundations and poles should be fixed now.</p>	<p>Oh Deer planned to be at the site 20-22 Oct to replace radios and make other modifications.</p> <p>WTI-MSU had informed Oh Deer many times that they should do a better job in keeping PennDOT and WTI-MSU informed about the problems, problem ID, strategy to address these problems and a time schedule for fixing each problem. WTI-MSU provided Oh Deer with a template for this.</p> <p>The Secretary of Transportation was scheduled to be on-site in PA October 29th for a press conference.</p> <p>WTI-MSU planned to be at the PA location 18-19 Nov.</p>
Oct 2004		<p>STS submitted the trip report from the Jul-Aug visit.</p> <p>STS delayed the scheduled visit to the site in MT again. They delayed arrival until 15 Nov. They would probably need about 2 weeks to get the system operational.</p> <p>The batteries at the MT site were checked for fluid levels and charged by an associate of STS.</p> <p>The site in IN seems mostly operational. There seems to be 1 section that suffers from hardware problems, and a series of other</p>	<p>Oh Deer was at the site 27-30 Oct. New processor boards and batteries were installed. There still were issues though with the sensitivity of the system and the communication between the animal detection and driver warning part of the system.</p> <p>The Secretary of Transportation could not make it on 29th for a press conference.</p> <p>Oh Deer had not provided a list of the outstanding issues and their status, strategy and time schedule yet, despite multiple</p>

Date	General Activities	Montana Site	Pennsylvania Site
		sections suffers from false positives caused by traffic (source STS).	reminders. Rhonda Stankavich (PennDOT) planned to install new boards for Oh Deer Wed 10 Nov WTI-MSU (Marcel Huijser) planned to be on location 18-19 Nov.
Nov 2004		STS visited the site 15-22 Nov and made changes to the hard- and software. The remote access through the modem was still a problem though.	PennDOT installed new boards for Oh Deer on 10 Dec. WTI-MSU (Marcel Huijser) visited the site on 18 and 19 Nov to meet with PennDOT representatives and test the reliability of the system. The system did not detect human models reliably on 18 Nov, and detailed detection data from that day were lost, according to Oh Deer. PennDOT removed the beacons and text warning signs on 19 Nov. Only the standard deer warning signs remain. PennDOT will no longer assist Oh Deer at the level they have been helping Oh Deer over the last months.
Dec 2004	Full draft report was presented to the TAC. The TAC meeting took place on 15-16 Dec.	WTI downloaded the data on 3 Dec. The patterns in the data since 22 Nov indicate that the system is indeed detecting large mammals (elk) and there is no indication of abundant false positives. MDT attached the beacons and warning signs on 13 Dec. The TAC and representatives from YNP, FHWA, STS and Oh DEER, Inc. visited the site on 15 Dec. STS visited the site again on 15 and 16 Dec. STS removed the memory card and sent the data to WTI on 23 Dec. A new memory card has been inserted. STS could not successfully install the modem for remote access. A new visit is planned for early January. WTI-MSU will start further tests at the MT site for system reliability, effectiveness and acceptance ASAP.	Oh Deer provided an overview of the known problems on 10 Dec using the template provided to them earlier. Oh Deer estimates that the system may become operational by 1 March 2005.
Jan 2005	WTI-MSU contributed additional funds to ensure that the MT site can	The animal detection system has been partially functional. For	Nick Henningsen from Oh Deer removed Oh Deer's equipment

Date	General Activities	Montana Site	Pennsylvania Site
	<p>be investigated with regard to system reliability and system effectiveness between 1 Jan - 30 Jun 2005.</p>	<p>details and dates see table 7.1. Potential causes are software errors, lack of a clear line of sight in between some of the stations and the master station. STS modified the software and tested it at their offices and local field sites (see chapter 6 for details). WTI-MSU visited the site on 26 and 27 Jan to upload the new software, change the memory card and re-initialize the animal detection part of the system. These actions were successful; all detection zones were active again (see Chapter 6 and 7). WTI-MSU hired a graduate student (Whisper Maillet) to collect snow tracking data to investigate the reliability of the system.</p>	<p>from the site on 31 Jan. However, Oh Deer did not remove the antennas. The antennas were not a problem, but they will be removed by Penndot at a later time.</p>
<p>Feb 2005</p>		<p>A preliminary report on the reliability of the system was presented to the funders (see chapter 7 for final report on system reliability).</p> <p>A software update on 10 Feb resulted in a substantial reduction of the radio failure rates. However, some stations lack a “line-of-sight” with the master station and still have relatively high radio failure rates. However, these radio failures do not result in overall system failure.</p>	
<p>Mar 2005</p>		<p>WTI-MSU stopped snow tracking on 4 Mar because of a lack of snow.</p> <p>An updated preliminary report on the reliability of the system was presented to the funders (see chapter 7 for final report on system reliability).</p> <p>The system started to produce false positives on 5 Mar in detection Zone 1 about 25 minutes after WTI-MSU personnel had left the site. Preliminary analyses indicated that the false positives seemed to last several hours at a time. STS and WTI-MSU started an investigation into the cause of the false positives. Initial thoughts are</p>	

Date	General Activities	Montana Site	Pennsylvania Site
		<p>that the sensors of detection Zone 1 may no longer be correctly aligned, but it is also possible that water (from snowmelt) that collected in the ditch caused deflections of the microwave signals.</p> <p>Despite the reliability of the system until 5 Mar, WTI-MSU advised not to connect the beacons and not attach the warning signs for the moment, mostly because of the abundance of false positives in detection Zone 1 since 5 Mar. The importance of remote access to check on the condition of the system at regular intervals was emphasized.</p> <p>WTI-MSU personnel went down to the study site several times to investigate what might be causing the bursts of false positives in detection Zone 1. The investigations included signal strength readings and the use of a scope to evaluate the alignment of the sensors, as well as a check for the presence of potential objects or reflections in the path of detection Zone 1 (e.g., melt water in ditch, rocks, trees, shrubs). The correct alignment of the sensors was confirmed by a local STS representative on 16 Mar. The cause for the false positives in detection Zone 1 was still unclear however. Further data analyses showed that detection Zone 9 sometimes showed suspicious detections, perhaps false positives. Again, field surveys did not show a clear cause.</p>	
Apr 2005	<p>The TAC meeting will be held on 13 and 14 June in Big Sky, MT.</p> <p>WTI-MSU provided answers to questions of YNP with regard to the purpose of the upcoming TAC meeting and the status of the system.</p> <p>WTI-MSU tried to set up a meeting with representatives of YNP to discuss the future of the site and the equipment, but the schedules of YNP personnel did not allow for a</p>	<p>WTI-MSU continued to investigate the cause for the false positives in Zone 1, but could not identify the source of the problem.</p> <p>STS is planning to come out to the site 1-9 May to investigate the cause for the problems in detection Zone 1. STS will also test the modem.</p>	

Date	General Activities	Montana Site	Pennsylvania Site
	<p>meeting. However, WTI-MSU and STS did set up a meeting with MDT representatives for Fri 6 May to discuss the expectations of MDT with regard to the future of the site and the equipment.</p>		
<p>May 2005</p>	<p>WTI-MSU and STS personnel met with MDT personnel on Fri 6 May to discuss the expectations of MDT with regard to the site and the equipment. MDT would like to keep the system in place, given certain conditions related to the reliability of the system and the approval of YNP.</p> <p>WTI-MSU sent YNP a list with questions about the potential expectations of YNP with regard to the site and the equipment. In return, YNP sent a letter explaining their request to have the system removed by 15 Sep 2005.</p>	<p>STS identified the cause for the false detections in detection Zone 1. It was caused by a broken bracket in detection Zone 0, just south of Zone 1. The misaligned signal from Zone 0 caused false detections in Zone 1. In addition, Zone 9 was found to have an all but broken wire. These problems were fixed by STS. Radio contact with station 3, and remote access with modem were still not entirely satisfactory, however.</p>	
<p>Jun 2005</p>	<p>The TAC meeting was held in Big Sky, MT on 13-14 June. The TAC members were pleased with the results of the reliability tests of the system. The test results triggered the TAC members to initiate a discussion with YNP about the test results and ask them to allow the system to stay in place so that the system could be evaluated with regard to its effectiveness. The end date for the contract was changed from 30 Jun 2005 to 31 Dec 2005 to allow for a potential transition to a Phase II of the project. However, IN, WI, AK and IA decided, for various reasons, not to contribute to the funding for Phase II.</p> <p>On Fri 17 Jun TAC representatives talked with YNP representatives about YNP's request to have the system removed by 15 Sep 2005. YNP representatives agreed to discuss the issue in greater detail with additional TAC representatives.</p> <p>STS and WTI-MSU provided cost estimates for different options of how to proceed with the effort.</p>	<p>STS successfully installed a modem for the land-based phone line and was in contact with the system on a daily basis over the telephone line. However, after a couple of weeks there was a failure on the logging memory, but the detectors continued to operate. The connection to the land-based phone line may be sensitive to lightning strikes.</p>	

Date	General Activities	Montana Site	Pennsylvania Site
Jul 2005	<p>On Thu 21 Jul a teleconference was held between representatives of the TAC and a representative from YNP to discuss the future of the site further. The TAC was asked to write a letter explaining their request to the superintendent of YNP.</p> <p>ODOT wrote a letter to YNP asking permission to keep the system in place and to continue the research for an additional 3 years.</p> <p>STS has been in contact with a company that provides remote control and automated warning systems for ITS applications. Such systems may help DOT's with the monitoring of the status of animal detection systems.</p>	<p>On 14 Jul WTI-MSU removed and reinstalled the memory card. STS tried to restart the data logging through the modem, but the procedure failed. This may have been due to a bad memory card; it may have been damaged as a result of a lighting strike. However, the system still detects animal movements and is functional.</p> <p>Detection Zone 1 seemed to suffer from false positives as a result of re-growth of a shrub. Limited mowing or cutting is required.</p>	
Aug 2005	<p>STS submitted a draft chapter for the final report on modifications to the system after it was installed. It was forwarded to the TAC for review.</p>		
Sep 2005	<p>ODOT received a response letter from YNP. The letter allowed for a 3 year extension of the project, given certain requirements and restrictions</p> <p>WTI started working on a draft work scope for the 3 year extension. This document will include requirements, definitions and checklists, and will be developed in close cooperation with MDT and ODOT. ODOT will coordinate the requirements, definitions and checklists with YNP.</p> <p>Carol Tan has replaced AJ Nedzesky as the FHWA representative.</p>	<p>MDT reported that a solar panel disappeared. WTI-MSU confirmed that the solar panel from station 17 was missing. It appeared to have been stolen and will be replaced in combination with other system modifications. According to Duncan Patten (Black Butte Ranch) the solar panel disappeared at least several weeks before it was reported.</p> <p>WTI-MSU observed that two new elk warning signs had been installed; one a couple of mi north of the site with the animal detection system and one about 8 mi south of the site. The signs have continuously activated LED lights outlining the sign. The sign was installed by YNP. WTI-MSU informed the park that the installation of the signs would complicate the evaluation of the system as it is no longer possible to distinguish between the effect of the presence of the system and the effect of the presence of the newly installed signs.</p>	

Date	General Activities	Montana Site	Pennsylvania Site
		STS conducted tests that suggested that the communication problems with station 3 may have been due to a software error of the manufacturer, and not necessarily because of a lack of a straight line of sight.	
Oct 2005	<p>ODOT stated that the 3 year extension will be an amendment to the existing contract.</p> <p>WTI-MSU prepared a draft work scope for the extension. The document was sent to the TAC for comments. In the mean time, ODOT coordinated the definitions, terms and requirements with YNP.</p>		
Nov 2005	<p>A teleconference was held on 8 Nov between ODOT, MDT and WTI-MSU to discuss the work plan and budget for Phase II. Further comments on work plan, budget and schedule were addressed.</p> <p>The survey for blind spots will be paid solely by WTI-MSU. This allowed the survey to take place as soon as the weather conditions allow.</p>	Waiting for more favorable weather conditions so that STS can conduct the survey.	
Dec 2005	<p>Further comments on work plan, budget and schedule were addressed. A new draft was presented to the TAC.</p> <p>ODOT and WTI signed the agreement for Phase II.</p> <p>WTI-MSU submitted an annual report to YNP and applied for a 2006 research permit from YNP.</p>	Waiting for more favorable weather conditions so that STS can conduct the survey.	

APPENDIX D: REQUEST FOR INFORMATION

Animal Vehicle Crash Mitigation Using Advanced Technologies

Request for Information

Colonnade Hotel - Boston, MA

May 5, 2000

Background

A pooled fund study was initiated by the Western Transportation Institute and the Oregon Department of Transportation to investigate advanced technologies to warn drivers of animal presence on the roadway. Specifically, the project will deploy up to four roadside demonstration sites that will detect animal presence on the roadway/roadside and activate dynamic signing to warn the motorist. Currently the effort is directed at larger (ungulate) animals such as deer, elk and moose. There are 12 states involved in the project (CA, IA, IN, MD, MT, ND, NH, NV, NY, OR, WI, and WY) with a total of \$300,000+ set aside for deployment. The purpose of this project is to demonstrate these technologies, evaluate their effectiveness and provide State Departments of Transportation with the results.

Purpose of Request for Information

The Technical Advisory Committee (TAC) is attempting to develop a request for proposal. However, there are several unanswered questions in regards to the abilities of the different technologies that may drive the scope including:

Cost constraints especially as they relate to the length of the detection zone (1/2 mile vs. 10 miles)

Accuracy/redundancy of detection method

Power requirements

Special limitations (temperature, precipitation, terrain, etc.)

As such the TAC is asking interested vendors to present to the committee their product, their specific approach to this project, and any challenges they foresee. This presentation will allow the TAC to develop the request for proposal in a manner that will best utilize the available technology.

Benefit to the Vendor

Participating in this request for information will (1) give you an opportunity to present you system and company to 12 different state departments of transportation (2) provide you the opportunity to meet the TAC, (3) allow you to provide input to the direction of this project to utilize the best possible solution(s), and (4) inform you of this projects efforts. As vendors may already be attending ITS America the meeting was scheduled around ITS America (May 1-4 in

Boston) in an attempt to ease travel costs. The project cannot afford to pay travel expenses incurred by the vendor for this meeting.

To Participate

In order to participate in this presentation please contact Pat McGowen, Western Transportation Institute at (406) 994-6303 or patm@coe.montana.edu to schedule a presentation on May 5 2000 in Boston. If you are unable to attend it is acceptable to submit written response to the questions in the next section. It is anticipated that one half hour will be scheduled for each vendor presentation. Unless requested otherwise by the vendor for proprietary reasons the presentations will be open to the public. Thank you for your interest.

Questions to Address

Vendors should address the following questions:

Is your system ready for deployment in a “real world” setting? If not, what research and development is required?

How accurate is your system in detecting ungulate animals on the roadside? How many false positive readings can be expected in a given time period? How many false negative readings can be expected as a percentage of the total number of animal crossings? Will factors such as temperatures (hot and cold), wind (wind blown grasses and debris), snow (falling and accumulated), sunlight, vehicle heat signatures and vibration, nearby fixtures such as railroad traffic, power lines, etc, affect equipment operation/deer detection of your system? Has any testing/evaluation been accomplished to validate these numbers?

Please estimate costs for the following: (1) fixed costs including development, integration, overhead, etc. and (2) cost per length for purchase and installation of sensors on the roadway. Also include factors (i.e., terrain, weather, etc.) that will affect these costs and to what extent.

What factors should be considered when selecting potential sites that may affect the accuracy and feasibility of implementation of your system? Refer to question 2 regarding possible environmental effects on system accuracy.

The implementation of this system is anticipated to be completed by Fall 2000 but no later than Fall 2001. Please comment on the appropriateness of this timeframe.

What area of coverage is provided by your system, ie., road edge to right of way fence? Along road edge only? Will sloping terrain affect this?

With your system once animals are detected, how will the presence of these animals be relayed to passing motorists (i.e., signs, flashing beacon, light)? If the detection zone is several miles long, would the warning be site specific (i.e., driver is warned within ¼ mile of the location of the animal) or would the warning be given throughout the test section? Would the motorist warning device(s) be included in your "system" or would the state DOT be expected to provide these? If so, how would the detection system interface with the DOT warning device(s). If the

warning system/device is a part of the overall "system", what are the power requirements? Is AC power required, can solar or wind generators be used?

With your system is there a way to remotely monitor the operation of the system? For instance, could the DOT remotely determine (1) if the system is on all the time, (2) if the system is never coming on at all, (3) how many times per day is it being set off and (4) the time of day of detection.

**APPENDIX E: ANIMAL DETECTIONS SYSTEM MANUFACTURER
CONTACT INFORMATION**

VENDOR CONTACTS

A. FOR EXISTING OR REMOVED SYSTEMS

ID. No. refers to ID # in Table 4.1.

ID 1, 4, 5. Calonder systems in CH, NL, D

Calonder Energie AG

Solar-Energytechnik

Wiesentalstrasse 7

Postfach 269

7004 Chur / GR, Switzerland

Main contacts: Peter Arnold / Gianreto Calonder / Giacomo Calonder

Phone: 011-41-81-353-1616, Fax: 011-41-81-353-1616 / 011-41-81-284-8153

E-mail: parnold@swissonline.ch / parts@calonder.com

Alternative address 1:

Calonder Energie AG

Giacomo Calonder

Werkhof, Oberalpstrasse 839

7016 Trin Mulin, Switzerland

Alternative address 2:

Calonder Energie AG

Solar-Energytechnik

Wiesentalstrasse 7

Postfach 269

7004 Chur / GR, Switzerland

Calonder Energie's representative in USA:

Willy Bärchtold

Swiss army vehicles

1436 Van Asche Drive

Fayetteville, AR 72704

Phone: 479-521-0056

E-mail: cars@sav.ms

ID 2. and 3. Sabik systems in Finland

Sabik Oy

P.O.Box 19

FIN06151 Porvoo, Finland

Visiting Address: Merituulentie 30, Porvoo

General Phone: 358-19-560 1100, General E-mail: sales@sabik.com

Main contact: Kari Taskula, RandD Manager

Phone: 011-358-19-560-1130, Fax: 011-358-19-560-1120, E-mail: kari.taskula@sabik.fi

Website: <http://www.sabik.fi/>

ID 6. Rosvik, S

PIK AB, Karlskrona, Sweden
Remainder address is unknown

ID 7. Colville, WA, USA

System designed by an electrical engineer (subcontracted) and manufactured in-house at the WSDOT Research Office. Additional information:

Brian Walsh (WSDOT)

Phone: 360-705-7387, E-mail: WalshB@wsdot.wa.gov

ID 8. Systems installed at Nugget Canyon, WY, USA

a. Flashing Light Animal Sensing Host (FLASH)

FLASH

Vickie Gooch

2611 East Clarene Court

Meridian ID 83642

Phone: 208-288-2443

E-mail: clangooch1@juno.com

b. Geophone system (**see also ID 18**)

Components: PT-200 Processor/Transmitter, TT-100 Wireless remote intervalometer system (transmitter/receiver), SP-500P Seismic detector string, IF-540 Long range passive infrared detector (scopes)

Telonics, Inc.

932 E. Impala Ave.

Mesa, AZ 85204, USA

Main contact: Chris McDonald

Phone: 480-892-4444 ext 197, Fax: 480-892-9139, E-mail: chris@telonics.com

Website: <http://www.telonics.com/>

c. Microwave radar

Components: RTMS Model X2A,

EIS Electronic Integrated Systems, Inc.

150 Bridgeland Ave.

Toronto, Ontario, Canada M6A 1Z5

Phone: 416-785-9248

d. Video system

Components: PATH-CV99MKII Color Portable Archival Traffic History,

Video System PATH-CCZ-32 Low light color cameras, PATH-EMC-2000 Infrared camera with wide angle lens

ATD Northwest, Inc.

18080 NE 68th St. # A-150

Redmond, WA 98052, USA

Main contact: Ken Kaylor

Phone: 425-558-0359, Fax: 425-558-9413, E-mail: atd@atdnw.com

ID 9. Sequim, WA, USA

David Rubin

“Elk Highway Collision Avoidance System”

Private effort for the Sequim Elk Habitat Committee, Washington Department of Transportation, Washington Department of Fish and Wildlife, and the US Department of Transportation.

Phone: 360-681-8448, E-mail: dnmir@olympen.com

ID 10. Lewis' system in Marshall MN, USA

E.L. Lewis Enterprises Inc.

7465 Oak Park Village Drive, Suite #9

St Louis Park MN 55426

Main contacts: Erick Lewis / Jacqueline K. Barabash

Phone: 952-936-9202 / 952-933-6935 / 612-597-8000, Fax 952-949-0944, E-mail:

sales@ericklewis.net

Website: www.ericklewis.net

ID 11. Rainbow Group system, Kootenay NP, BC, Canada

Rainbow Group of Companies Incorporated

11450-149 Street

Edmonton, AB T5M 1W7, Canada

Phone: 1-780-9098079, Fax: 1-780-4187714, E-mail: mkaufmann@rbpgroup.com

Website: <http://www.rbpgroup.com>

Intranstech Corporation

P.O. Box 815

Postal Station M

Calgary T2P 2J6, Alberta, Canada

QWIP Technologies

2400 Lincoln Avenue

Altadena, CA 91001, USA

Phone: 626-296-6432, Fax: (626) 296-6442, E-mail: technical@qwip.com

Website: <http://www.qwip.com/>

ID 12. and 14. STS's system, Yellowstone NP, MT, USA

Sensor Technologies and Systems, Inc.

8900 East Chaparral Road

Scottsdale, AZ 85250, USA

Main contact: Terry Wilson

E-mail: terry_wilson@sensor-tech.com

Phone: 480-483-1997, Fax: 480-483-2011

Website: www.sensor-tech.com

ID 13. Wenatchee, WA, USA

Marine Sciences Division

Battelle Marine Sciences Laboratory

Part of Pacific Northwest National Laboratory
1529 West Sequim Bay Road
Sequim, WA 98382
Main contact: Parks Gribble and Ronald Thom
Phone: 360-681-3674 (Parks Gribble)
E-mail: ron.thom@pnl.gov / r.p.gribble@pnl.gov
<http://environment.pnl.gov/default.asp>

ID 15. Los Alamos, NM, USA

a. sensors
Goodson and Associates, Inc
10614 Widmer
Lenexa, KS 66215, USA
Main contact: Bill Goodson
Phone: 1-800-544-5415 / 913-345-8555, Fax: 913-345-8555, E-mail: sales@trailmaster.com
<http://www.trailmaster.com/company.php>

b. video equipment for monitoring
Fuhrman Diversified, Inc.
2912 Bayport Blvd.
Seabrook, TX 77586-1501, USA
Main contact: Richard Fuhrman
Phone: 281-474-1388, Fax: 281-474-1390, E-mail: fdi@flash.net
Website: <http://www.fieldcam.com/>

ID 16. Thompsontown, PA, USA

Oh Deer Inc.
1002 East State Street
Mason City, IA 50401, USA
Main contact: Nick Henningsen
Phone: 641-380-0045, Fax: 641-423-7514, E-mail: nhenningsen@hotmail.com
Website: <http://www.ohdeer.net>

ID 17. Herbertville, Quebec, Canada

Service Camera Pro,
2042 boul Pere Lelievre
Quebec City, PQ
G1P 2W9 Canada
Phone: 418-688-8222, Fax: 418-688-8222

ID 18. Pinedale, WY, USA

Geophone system (see also ID 8)
Components: PT-200 Processor/Transmitter, TT-100 Wireless remote intervalometer system (transmitter/receiver), SP-500P Seismic detector string, IF-540 Long range passive infrared detector (scopes)
Telonics, Inc.

932 E. Impala Ave.
Mesa, AZ 85204, USA
Main contact: Chris McDonald
Phone: 480-892-444 ext 197, Fax: 480-892-9139, E-mail: chris@telonics.com
Website: <http://www.telonics.com/>

ID 19. Norway

No name or contact information available.

B. ADDITIONAL VENDORS (SYSTEM NOT INSTALLED IN ROADSIDE ENVIRONMENT YET)

International Road Dynamics Inc. (IRD)
702 43rd St East
Saskatoon, SK
Canada S7K 3T9
Main contact: Rob Bushman
Phone: 306-653-6600, Fax 306-242-5599, E-mail: rob.bushman@irdinc.com

ASIM Technologies, Inc.
P.O. Box 12
505 Middlesex Turnpike, Suite 5
Billerica, MA 01821
USA
Main contact: Andreas Hartmann
Phone: 978 667 5207, Fax: 978 667 8247
Toll-free: 1-866-664-ASIM(2746)
E-mail: ahartmann@asim-technologies.com
Website: <http://www.asim-technologies.com/>

APPENDIX F: PROJECT PARTNERS AND CONTRACTORS

MT site

Sensor Technologies and Systems, Inc.
8900 East Chaparral Road
Scottsdale, Arizona 85250
Main contact: Terry Wilson
E-mail: terry_wilson@sensor-tech.com
Phone: 480-483-1997
Fax: 480-483-2011
Website: www.sensor-tech.com

Michiana Contracting, Inc.
7843 Lilac Road
P.O. Box 929
Plymouth, Indiana 46563
Main contact: Dave Delp
Phone: 574-936-8613
Fax: 574-936-6201
Email: info@michianacontracting.com

Dependable Paint and Drywall, Inc.
Bozeman, MT 59715
Phone: (406) 587-2523

Eagle Rock Timber Inc.
3000 Wright Road
Idaho Falls ID 83401
Contact: Rick Gokey
Phone: 208-529-4925
E-mail: ert@ida.net

3 Rivers Communications
PO Box 429
Fairfield, MT 59436
406-467-2535 or 800-796-4567
E-mail: 3rt@3rivers.net
Website: www.3rivers.net

Montana Department of Transportation
PO Box 201001 | 2701 Prospect Avenue
Helena, MT 59620-1001
Main contact: Kevin Bruski
Phone: 406-444-6305
Email: kbruski@mt.gov
Website: <http://www.mdt.state.mt.us/>

Yellowstone National Park
P.O. Box 168
Yellowstone National Park, WY 82190-0168
Main contact: Christie Hendrix
Research Permit Coordinator
Phone: 307-344-2234
Fax: 307-344-2211
E-mail: Christie_Hendrix@nps.gov

Western Transportation Institute
Montana State University
PO Box 174250
Bozeman MT 59717-4250
Main contact: Marcel Huijser
Phone: 406-543-2377
E-mail: mhuijser@coe.montana.edu
Website: <http://www.coe.montana.edu/wti/>

PA site

Oh Deer Inc.
1002 East State Street
Mason City, IA 50401
Main contact: Nick Henningsen
E-mail: nhenningsen@hotmail.com
Phone: 641-380-0045
Fax: 641-423-7514
Website: <http://www.ohdeer.net>

Signal Service, Inc.
1020 Andrew Drive
West Chester, PA 19380
Phone: 610-429-8073
Fax: 610-429-8076
E-mail: sales@signalservice.com
Website: <http://www.signalservice.com/>

Sprint
Phone: 1-800-322-3961
Website: <http://www.sprint.com/>

PPL Corporation
Website: <http://www.pplweb.com/>

Edwards and Kelcey
Corporate Headquarters
299 Madison Ave
P.O. Box 1936
Morristown, New Jersey 07962-1936
Phone: 973-267-0555
Fax: 973-267-3555
Website: <http://www.ekcorp.com/>

PENNDOT Central Office
Keystone Building
400 North Street
Harrisburg, PA 17120
Main contact: Jon Fleming
Phone: 717-772-1771
E-mail: JonFleming@state.pa.us
Website: <http://www.dot.state.pa.us/>

Western Transportation Institute
Montana State University
PO Box 174250
Bozeman, MT 59717-4250
Main contact: Marcel Huijser
Phone: 406-543-2377
E-mail: mhuijser@coe.montana.edu
Website: <http://www.coe.montana.edu/wti/>

**APPENDIX G: PROJECT RELEATED PRESENTATIONS, AND
PUBLICATIONS**

Presentations

Challenges of advanced signing technology applications. Oral presentation at Deer-Vehicle Crash Information Clearinghouse Workshop, Midwest Regional University Transportation Center, Madison, Wisconsin, USA., 4 February 2003.

Wildlife-Transportation Interactions: effects and mitigation measures. Oral presentation for “Mountains and Minds” lecture series, Big Sky Institute, Big Sky, Montana, USA., 12 February 2003.

Overview of animal detection and animal warning systems in North America and Europe. Oral presentation at the International Conference on Ecology and Transportation (ICOET), 24-29 August 2003, Lake Placid Resort, Lake Placid, New York, USA.

Overview of animal detection and animal warning systems in North America and Europe. Oral presentation at the International Conference on Habitat Fragmentation due to Transport Infrastructure and Presentation to the COST341 action, 13-15 November 2003 Brussels, Belgium.

Overview of animal detection and animal warning systems in North America and Europe. Oral presentation at the 83rd annual meeting of the Transportation Research Board of the National Academies. 11-15 January 2004 Washington DC, USA.

Overview of animal detection and animal warning systems in North America and Europe. Oral presentation at the 83rd annual meeting of the Western Association of State Highway and Transportation Officials (WASHTO). 18-21 July 2004, Kalispell, MT, USA.

Transportation and ecology: effects and potential avoidance, mitigation and compensation strategies. Oral presentation for course “Conservation and Community in the Yellowstone to Yukon Region”. Wild Rockies Field Institute. 21 July 2004, Swan Valley, MT, USA.

Overview of animal detection and animal warning systems in North America and Europe. Oral presentation (teleconference) for FHWA Rural ITS Workgroup. 29 July 2004.

The reliability of the animal detection system along Hwy 191 in Yellowstone National Park, MT. ICOET 2005, San Diego, 2 September 2005.

The reliability of the animal detection system along US Hwy 191 in Yellowstone National Park, Montana, USA. Oral presentation at the Craighead Environmental Research Institute (CERI) B-Bar Meeting/workshop on Conservation Area (Reserve) Design: October 8-12 2005, B-Bar ranch, MT, USA.

The reliability of the animal detection system along US Hwy 191 in Yellowstone National Park, Montana, USA. Oral presentation at the 85th annual meeting of the Transportation Research Board of the National Academies. 22-26 January 2006 Washington DC, USA.

The reliability of the animal detection system along US Hwy 191 in Yellowstone National Park, Montana, USA. Oral presentation at the NW Transportation Conference, February 7-9, 2006, Oregon State University, Corvallis, Oregon, USA.

Publications

Farrell, J.E. 2002. Intelligent countermeasures in ungulate-vehicle collision mitigation. Professional paper, Montana State University, Bozeman, MT, USA.

Farrell, J.E., L.R. Irby and P.T. McGowen. 2002. Strategies for ungulate-vehicle collision mitigation. *Intermountain Journal of Sciences* 8 (1): 1-18.

Huijser, M.P. 2003. Animal detection systems: research questions, methods and potential applications: 9 p. Proceedings of Infra Eco Network Europe (IENE) conference. Habitat Fragmentation due to Transport Infrastructure and Presentation of the COST 341 action, 13 - 15 November 2003, Brussels, Belgium. CD-ROMs with the proceedings can be ordered from the internet. URL: <http://www.iene.info/> Accessed 27 September 2004.

Huijser, M.P. and P.T. McGowen. 2003. Overview of animal detection and animal warning systems in North America and Europe. Pages 368-382 in: C.L. Irwin, P. Garrett, and K.P. McDermott (eds.). 2003 Proceedings of the International Conference on Ecology and Transportation. Center for Transportation and the Environment, North Carolina State University, Raleigh, NC, USA. Also available from the internet. URL: <http://www.itre.ncsu.edu/cte/icoet/03proceedings.html>

Huijser, M.P., W. Camel and A. Hardy. 2006. The reliability of the animal detection system along US Hwy 191 in Yellowstone National Park, Montana, USA. Pages: 509-523 in: C.L. Irwin, P. Garrett and K.P. McDermott (eds.). Proceedings of the 2005 International Conference on Ecology and Transportation. Center for Transportation and the Environment, North Carolina State University, Raleigh, NC, USA. URL: http://www.icoet.net/ICOET_2005/05proceedings_directory.asp

Robinson, M., P. McGowen, A. Habets and C. Strong. 2002. Safety Applications of ITS in Rural Areas. Science Applications International Corporation, McLean, VA, USA. Available from the internet. URL: http://www.itsdocs.fhwa.dot.gov/JPODOCS/REPTS_TE/Contents.htm Accessed 14 August 2003.

Interviews, Newspaper and Magazine Articles

Date	Newspaper or Magazine	Title
31 October, 2002	West Yellowstone News	New detection system aims to cut down on animal/vehicle collisions
25 November 2002	Wisconsin State Journal	Despite deer kill, 20,000 crashes each of last 5 years
26 November 2002	Wisconsin State Journal	Car-deer crashes still high
26 November 2002	Manitowoc Herald Times Reporter	Deer-vehicle crashes still at 20,000
December 2002	Jackson Hole Guide Regional Transportation Connector, (NADO)	New radar to be tested in plan to stop roadkill
Fall 2002	Yellowstone Science, 4(10): 28	ITS Allows Vehicles and Animals to Share the Road Experimental Animal Detection Driver Warning System Installed
2002		
7 January 2003	The Bozeman Daily Chronicle	Mountains and Minds Lecture Series
6 February 2003	The Bozeman Daily Chronicle	Early warning system: Sensors will let drivers know elk are on road
6 February 2003	West Yellowstone News	And then what happened: West Yellowstone News follows-up on recent events
7 February 2003	The Billings Gazette	System warns of deer on the road
February 2003	NBC 15 WMTV Madison	Car Vs. Deer Accidents
3 May 2003	Washington Post	Saving Lives of Moose and Men States get creative in ways of saving lives of moose and men
3 May 2004	Lincoln Journal Star	
4 May 2004	The Seattle Times	Critter-crossing strategies pick up speed
3 August 2003	Electronic Design	Innovative Electronics Mitigate Roadkill Risks
7 November 2003	West Yellowstone News	Animal Detection Goes Back to Drawing
1 July 2004	The Bozeman Daily Chronicle	Sensors to warn of wildlife on section of U.S. 191
2 July 2004	The Billings Gazette	Solar-powered signal will warn drivers of elk
2 July 2004	Independent Record	System will warn motorists of wildlife on road
2 July 2004	Y2Y Conservation News TRIPinfo.com, Internet	Solar-powered signal light will warn drivers of wildlife
8 July 2004	Travel Monitor – Technology Bits	Solar-Powered System Warns of Animals on Road Heads up: New system combats animal, vehicle wrecks with technology
29 July 2004	Lone Peak Lookout	
27 October 2004	The Patriot News	High-tech deer signs run into a cyber glitch
29 October 2004	21 WHP Harrisburg, Clear Channel Radio	Oh, Deer
28 November 2004	The Philadelphia Inquirer	Safety for deer, drivers

Date	Newspaper or Magazine	Title
2004	Conservation in Practice 5 (1)	Road Kill
2 January 2005	The Missoulian	Sensor would alert drivers to wildlife near road
2 January 2005	The Times-News	Sensor would alert drivers to wildlife near road
2 January 2005	The Billings Gazette	Park tests road-kill technology
3 January 2005	ESPN Outdoors	Yellowstone to test road-kill technology
4 January 2005	Spitting Image	Wildlife Sensors
4 January 2005	Park tests road-kill technology	CodyCafe.com
January 2005	Montana Greenpower	Solar-Powered Elk Early Warning System Installed on Yellowstone Highway
21 March 2005	Waterbury Republican-American	Of moose and men: Roads redesigned to save wildlife
10 April 2005	ABC News	Engineers Redesign Roads to Save Moose. Traffic Engineers Experimenting With Redesigning Roads to Accommodate Wandering Moose
30 March 2005	The Arizona Republic	Sensor's radar systems vault NE Valley firm into limelight. Radar systems put tech firm on map.
Spring 2005	National Association of County Planners (NACP) News	Wildlife collisions and mitigation efforts
11 April 2005	New York Times	Engineers Redesign Roads to Save Moose
18 May 2005	ABC	
6 June 2005	CBS Evening News with Bob Schieffer	
August 2005	Government Technology	
27 September 2005	18(8): 44-46	What's That Ahead?
1 February 2006	The Bismarck Tribune	Beacons to Reduce Deer Collisions
2006	Inside ITS 16(3): p.1, 10-11	Animal Warning System. Animal-Vehicle Collision Warning Study Continues. Inside ITS

APPENDIX H: RAW DATA RELIABILITY TEST PENNSYLVANIA SITE

The system was tested on 18 November 2004 by Jon Fleming and Rhonda Stankavich (PennDOT) and Marcel Huijser (WTI-MSU). Jon Fleming and Marcel Huijser tried to trigger the system in different detection zones while Rhonda watched the flashing warning light (activated or not). For location of the stations see Figure 5.14.

Time	Event	Beacon
14:55:22	enter detection zone WB-1-East	off
14:56:50		on
14:57:49		on
14:58:09	at WB-1	off
15:00:17	at WB-2	off
15:00:42	enter WB-2-West	off
15:02:36	at WB-3	off
15:04:50	at WB-4, waving in front of sensor	on
15:05:07	at WB-4, waving in front of sensor	on
15:05:30	at WB-4, waving in front of west sensor	on
15:06:34	at WB-4, walking on east side	on
15:07:05	at WB-4, walking on east side	on
15:07:47	at WB-4, walking on east side	on
15:09:00	arrived on other side of road (at EB3-West zone)	off
15:09:58	at EB-4	off
15:11:32	at EB-5	off
15:11:50	run around EB-5 10-25 m radius	off
15:12:36	run around EB-5 10-25 m radius	off
15:13:16	wave in front of EB-5-West	on
15:13:49	tap on box	off
15:15:21	start walk on west side of EB-5	off
15:18:50	walk on east side of EB-6	on
15:22:26	Jon Fleming starts walking	off
15:22:47	Jon Fleming enters west side EB-6, 10 m distance	off
15:23:08	Jon Fleming enters east side EB-6	off
15:24:33	tap on sensor box EB-6-West	on
	start walking back along EB lanes in detection zone	off
15:28:43	Jon Fleming and Marcel Huijser were not moving	on

Time	Event	Beacon
15:28:44	Jon Fleming and Marcel Huijser were not moving	on
15:29:07	at EB-5	off
15:30:23	at EB-4	off
15:32:10	at EB-3, tapping, moving post	off
15:33:12	leave EB-3, in east detection zone	off
15:34:15	west of EB-2	on
15:34:16	west of EB-2	on
15:34:58	walk	on
15:35:05	standing still	on
15:35:26	at EB-2	off
15:35:40		on
15:36:59	walk near EB-1, west side	on
15:36:02	stand still, near EB-1, west side	on
15:37:37	at EB-1	off

